



Endoscopy



# 2009 Product Catalog

## Sales and Service Policies

Sales and Service Policies	.i
Trademarks	.ii
Patents	.iii
Returned Goods Policy	.iv
Smith & Nephew AGILE-CARE® Instrument Services	.v
AGILE-CARE® Factory Service	.vi
AGILE-CARE On-Site Service	.vii
Service Program Notations	.viii
Service Centers	.ix
New Product Warranty	.x
Service Replacement and Repair Warranty	.x
International Contacts	.xi
International Distributors	.xii
Financial Benefits	.xiii
Financial Programs	.xiii
Smith & Nephew Endoscopy Financial Services	.xiii

## A Tissue Repair

TRUREPAIR® Solutions	.A-1
----------------------	------

## B Arthroscopes

VideoArthroscopes, Autoclavable	.B-1
VideoArthroscopes, Non-Autoclavable	.B-2
Direct-View Arthroscopes	.B-4
Direct-View Arthroscopes, Autoclavable	.B-4
Direct-View Arthroscopes, Non-Autoclavable	.B-4
Specialty Endoscopes (ECTRA® II) and Accessories	.B-5
Made to Order	.B-6

## C Arthroscopic Cannula Systems

Cannulas, Trocars, and Obturators	.C-1
Hip Arthroscopy	.C-7
Cannulas, Obturators, and Irrigation Extenders	.C-7
Small Joint Cannula Sets	.C-8
INTELIJET® Reusable Cannulas	.C-10
Disposable Cannulas	.C-12
CLEAR-TRAC® COMPLETE Disposable Cannula System	.C-12
CLEAR-TRAC FLEXIBLE Disposable Cannula System	.C-13
Made to Order	.C-16
Replacement O-Rings	.C-19
ARTHROPAK®	.C-20
Customized Procedure Kit	.C-20

## D Shaver Systems

Smith & Nephew DYONICS® POWER Control Systems	.D-1
Smith & Nephew DYONICS® Motor Drive Units	.D-2
Accessories	.D-3
Replacement Parts	.D-4

## E Sterile Disposable Blades and Burrs

Smith & Nephew DYONICS® ELECTROBLADE® Resector	.E-1
Smith & Nephew DYONICS® BONECUTTER® Blades	.E-2
Smith & Nephew DYONICS® ORBIT® Curved Blades	.E-3
Pre-Curved and Long Disposable Blades	.E-4
Straight Disposable Blades	.E-5
Disposable Burrs	.E-7
Disposable Small Joint Blades/Burrs	.E-8
Disposable Mini Blades/Burrs	.E-9
Disposable Mini Blades — Long and Curved	.E-10
Short Sheath Components	.E-11

## F Fluid Management

DYONICS® 25 Fluid Management System, Control Unit, Tube Sets, and Accessories	F-1
DYONICS® 25 Carts	F-3
InteliJET® Tube Sets	F-4
Smith & Nephew Access 15 Irrigation System	F-5
ARTHROPAK®	F-6
Customized Procedure Kit	F-6

## G Punches, Scissors, Graspers, and Knives

Smith & Nephew ACUFEX® and ACUFEX® Pro Punches	G-1
Suction Punches	G-5
Suction Punches/Accessories	G-6
Smith & Nephew ACUFEX® and ACUFEX Pro Scissors	G-7
Smith & Nephew ACUFEX® and ACUFEX Pro Graspers	G-8
Smith & Nephew ACUFEX® Small Joint Instruments	G-10
Smith & Nephew ACUFEX® Knives	G-11
Probes	G-12
Instrument Sterilization Trays	G-13
Recommended Instrument Sets	G-14
Care and Maintenance	G-17
Made to Order	G-18
Punches	G-18
Scissors, Graspers, Rongeurs, Knives, and Magnetic Retrievers	G-20
Made to Order	G-21
Small Joint Instruments, Micro Instruments, Curettes, Chondral Picks, and Sterilization Tray	G-21

## H Knee Arthroscopy

Meniscal Repair Systems	H-1
ULTRA FAST-FIX® (all inside)	H-1
FAST-FIX® (all inside)	H-1
T-FIX® (all inside)	H-2
Meniscus Mender II (outside-in)	H-3
Meniscal Stitcher Set (inside-out)	H-4
Diamond Rasps	H-5

ACL/PCL Fixation Systems	H-6
ENDOBUTTON® CL ULTRA Fixation Device	H-6
ENDOBUTTON® DIRECT Fixation Device	H-6
ENDOBUTTON® CL BTB Fixation Device	H-7
XTENDOBUTTON Fixation Device	H-7
CL Device	H-8
ENDOBUTTON® Fixation Device	H-8
Graft Sleeves	H-9
WHIPKNOT® Soft Tissue Cinch	H-9
BIORCI®-HA Screws	H-10
BIORCI Screws	H-11
BIORCI Screw Instrumentation System	H-12
BIOSURE®-HA Interference Screw	H-13
RCI Screws	H-15
RCI Screw Instrumentation System	H-16
ENDO-FIX® L Screw System	H-18
SOFTSILK® Screw Systems	H-20
Screw Cannulas and Screw Fixation	H-21
TRAILBLAZER® Wire Guides, Screw Guides, and Screw Guide Wires	H-22
Spiked Washer/Tibial Anchor	H-23
Fixation Posts	H-24
Suture Fixation	H-25
Graft Harvesting/Preparation	H-26
Graft Harvesting Instruments	H-26
GRAFTMASTER® II and GTS Preparation Systems	H-27
ACL/PCL Reconstruction Drill Guide Systems	H-29
Clancy Anatomic Cruciate Guide/Flexible Drill System	H-29
ACUFEX® Anatomic ACL Guide Systems	H-29
ACUFEX® Director ACL System Sets	H-31
ACL Revision REDUX® System	H-36
TRE-CORE® Trephine System	H-38
TUNDRA® ACL/PCL Aimer System	H-39
ACUFEX® Director PCL System	H-40
ACL/PCL Drill Guide System Components & Accessories	H-41
ACUFEX® Director System Set Components	H-41
Offset Guides and Aimers	H-43
Rear Entry Components	H-44
MULTI-TRAC® Components	H-45
Drill Bits, Routers & Bone Graft Compressors	H-46
Sizing Tubes, Dilators, and Blocks	H-49

ACL Arthroplasty Instruments	H-50
PCL Arthroplasty Instruments	H-52
MCL MicroPerforation Instruments	H-53
Bone Tunnel Plugs	H-53
Isometry	H-54
Cruciate Pins and Wires	H-55
Cruciate Accessory Pacs	H-57
Chondral Resurfacing Systems	H-62
MOSAICPLASTY®	H-62
Chondral Picks	H-63
Cruciate Reconstruction	H-64
Leg Holder, Pads and Inserts	H-64
ARTHROPAK®	H-65
Customized Procedure Kit	H-65

## I Shoulder Arthroscopy

Soft Tissue Fixation - Metallic Anchors	I-1
TWINFIX® Ti 5.0 and TWINFIX Ti 6.5 Suture Anchors	I-1
TWINFIX® Ti 3.5 and TWINFIX Ti 2.8 Suture Anchors	I-2
TWINFIX® Ti QUICK-T® Fixation System	I-3
Individually packaged anchors and accessories	I-4
Soft Tissue Fixation – Absorbable Polymer Anchors	I-5
TWINFIX® AB 5.0 and TWINFIX AB 6.5 Suture Anchors	I-5
BIORAPTOR® 2.9 Suture Anchor	I-6
BIORAPTOR® 2.9 AB Suture Anchor with Needles	I-7
TAG® Suture Anchors and Arthroscopic TAG Instrument Systems	I-8
Soft Tissue Fixation – Non-absorbable Polymer Anchors	I-9
BIORAPTOR® 2.3 Suture Anchors	I-9
BIORAPTOR® 2.3 PK Suture Anchor with Needles	I-10
KINSA® Suture Anchor	I-11
TWINFIX® PK FT Suture Anchors	I-12
FOOTPRINT® PK Suture Anchor	I-13
KINSA® RC Suture Anchor	I-14
Non-absorbable TAG® Suture Anchors	I-15
Non-Absorbable Polymer Anchors	I-16
Arthroscopic TAG® Instrument Systems	I-16
Soft Tissue Fixation – TAG® Instrumentation	I-17
Arthroscopic TAG® Instrument Components	I-17
Soft Tissue Fixation – Tissue Tacks	I-18
SURETAC® III Fixation Devices and Rapid Delivery System	I-18
SURETAC® and SURETAC II Bioabsorbable Fixation and Instrumentation	I-19
SURETAC® Instrumentation System	I-20
SURETAC® Instrumentation Components	I-21
SURETAC® IXC Instrumentation System	I-22
SURETAC® IXC Instrumentation Components	I-23
Soft Tissue Fixation – Sutures	I-24
ULTRABRAID® High Strength Suture	I-24
Disposable Cannulas	I-25
CLEAR-TRAC® COMPLETE Disposable Cannula System	I-25
CLEAR-TRAC® FLEXIBLE Disposable Cannula System	I-26
Shoulder Access	I-27
Portal Accessory System	I-27
Shoulder Arthroscopy Portal Products	I-28
Suture Passing	I-29
ELITE® PASS Premium Arthroscopic Suture Shuttle	I-29
ACCU-PASS® Suture Shuttles	I-30
Reusable Suture Shuttle Instrumentation	I-31
Instrumentation Systems	I-33
ELITE® Premium Gold System	I-33
ELITE® Premium Essential System	I-34
Arthroscopic TAG® Instrument Systems	I-35
SURETAC® Instrumentation Systems	I-36
SURETAC® and TAG® Systems Shoulder Accessory Kit	I-37
Patient Positioning	I-38
TENET T-MAX System (beach chair positioner)	I-38
T-MAX Shoulder Positioners: Components and Accessories	I-39
TENET SPIDER Limb Positioner: Components and Accessories	I-40
T-MAX Shoulder Positioners: Components and Accessories	I-41
Small Joint Positioners	I-42
Disposable Kits for Shoulder Arthroscopy	I-43
Shoulder Traction Products	I-44

## Table of Contents

Accessories, Instrumentation	I-45
ELITE® Premium Shoulder System	I-45
Accessories, Instrumentation	I-47
Arthroscopic Capsular Release	I-47
Made to Order	I-48
Instruments and Accessories	I-48
ARTHROPAK®	I-49
Customized Procedure Kit	I-49

## J Small Joint Arthroscopy

Small Joint Suture Anchors and Anchor Accessories	J-1
MINI-TAG® Systems	J-2
Guhl Non-Invasive Ankle Distractor System	J-3
Small Joint Arthroscopy Distraction	J-3
Ferkel Thigh System	J-3
Small Joint Arthroscopy Distraction	J-4
Limb Positioners	J-4
Small Joint Arthroscopy Instrumentation	J-5
Foot and Ankle Arthroscopy Instruments	J-5
Hand and Wrist Instruments	J-7
Small Joint Cannula Sets	J-8
Shaver Systems	J-10
Smith & Nephew DYONICS® Motor Drive Units	J-10
Visualization	J-11
Small Joint Arthroscopes	J-11
Procedure Specific Solutions	J-12
Triangular Fibrocartilage Complex	J-12
Flexor Tendon Release – Trigger Finger System	J-13
Carpal Tunnel Ligament Repair – ECTRA® II Systems	J-14
ARTHROPAK®	J-19
Customized Procedure Kit	J-19

## K Hip Arthroscopy

Hip Arthroscopy – Visualization	K-1
Smith & Nephew Hip Positioning Systems	K-2
Supine Hip Positioning System	K-2
Lateral Hip Positioning System	K-3
SPIDER Hip Positioning System	K-4
Hip Arthroscopy Set	K-5
Cannulas, Obturators, and Irrigation Extenders	K-5
CROSSTRAC® Hip Guide System	K-6
Hip Arthroscopy Set – Hand Instruments and Accessories	K-7
Hip Arthroscopy – Resection Products	K-8
Hip Repair	K-9
ARTHROPAK®	K-11
Customized Procedure Kit	K-11

## L Laparoscopy

Laparoscopes	L-1
Endoscope & Laparoscope Accessories	L-2
Hysteroscopes/Cystourethroscopes and Hysteroscopic Sheaths	L-3
Made to Order	L-4
Laparoscopes	L-4

## M Illumination Equipment

Light Sources – Xenon Illuminators	M-1
Light Source Replacement Parts	M-2
Fiber Optic Light Cables and Adaptors	M-3
Compatibility Matrix	M-5

## N Surgical Video

Smith & Nephew 560P Camera Control Units	N-1
Smith & Nephew 450P/460P Camera Control Units	N-2
Smith & Nephew 470H Progressive Scan Autoclavable Camera Head	N-3

## O Video Accessories

Video Image Capture Devices	O-1
Video Monitors	O-2
Video Printers and Recorders	O-3
Video Printer Paper/Printer Accessories	O-4
Video Couplers and Adaptors	O-5
Video and Accessory Cables	O-7
Video Carts and Accessories	O-8
Made to Order	O-10

## P Sterilization Trays and Miscellaneous Accessories

Storage and Sterilization Trays	P-1
Storage and Sterilization Trays/Personal Protection Items	P-4
Fracture Support Table	P-5
Made to Order	P-6

## Q Electrosurgery

Smith & Nephew DYONICS® VULCAN® Arthroscopy System	Q-1
SAPHYRE® Bipolar Ablation Probes	Q-2
Monopolar Ablation Probes	Q-3
DYONICS® GLIDER® Articular Cartilage Probe	Q-4
Temperature Control Probes	Q-5
LIGAMENT CHISEL® Probes	Q-6
Hip Probes	Q-7
Small Joint Probes	Q-8
Arthroscopic Electrodes, Probes, and Switchpens	Q-9

## R Powered Instruments

Smith & Nephew DYONICS® POWER Instrumentation (battery-operated)	R-1
Accessories	R-2
Smith & Nephew DYONICS® POWER Instrumentation (corded)	R-4
Accessories	R-6

## S Endosurgery

Smith & Nephew Operative Hysteroscopy System	S-1
Individual Components	S-2
INTERCEPTRE® Modular Instruments	S-3
Laparoscopic Instruments	S-5
Smith & Nephew 400 Insufflator	S-7
Made to Order	S-8

## Index

Part Number Index	1
Alphabetical Index	13
Order Form	19



# Sales and Service Policies

Sales and Service Policies .....	i
Trademarks .....	ii
Patents .....	iii
Returned Goods Policy.....	iv
Smith & Nephew AGILE-CARE <sup>®</sup> Instrument Services .....	v
AGILE-CARE Factory Service .....	vi
AGILE-CARE On-Site Service .....	vii
Service Program Notations .....	viii
Service Centers.....	ix
Service Replacement and Repair Warranty .....	x
New Product Warranty .....	x
International Contacts .....	xi
International Contacts .....	xii
Benefits .....	xiii
Programs .....	xiii
Smith & Nephew Endoscopy Financial Services.....	xiii

## Sales and Service Policies

### Prices:

Due to our continuing product improvement, Smith & Nephew Endoscopy reserves the right to change product prices and to discontinue product without prior notice.

### Taxes Outside the U.S.:

The amount of any applicable sales, use, excise or other municipal, state, or federal taxes will be billed and collected by the selling company.

### Taxes in the U.S.:

The amount of any applicable sales, use, excise, or other municipal, state, or federal taxes will be billed and collected by Smith & Nephew Endoscopy unless the customer possesses and provides an exemption certificate.

### Terms of Payment:

For sales to customers residing in the U.S., the terms are net 30 days from date of invoice. Outside the U.S., please refer to terms defined by your Smith & Nephew Endoscopy Representative.

### Delivery Outside the U.S.:

Unless otherwise specified, we reserve the right to make partial shipments and invoice them accordingly. Contact your Smith & Nephew Endoscopy Representative for specific delivery information in your country.

### Delivery in the U.S.:

Shipment methods are at Smith & Nephew Endoscopy's discretion and all deliveries are F.O.B., Andover and Mansfield, Massachusetts, or Oklahoma City, Oklahoma, unless otherwise stated.

Standing orders can be arranged upon request. Please identify the product and quantity to be delivered to your facility on a weekly or monthly basis.

Next day delivery is available on all product requests received by 6 pm EST. Contact Smith & Nephew Customer Service for availability.

In certain areas special arrangements can be made, if required, for product delivery by 8 am local time.

### Product Availability:

Not all products listed in this catalog are available in all countries. Contact your local Smith & Nephew Endoscopy representative.

### Warranty:

Smith & Nephew Endoscopy products are guaranteed to be free from defects in material and workmanship for the warranty period for a particular product, beginning from date of invoice. This warranty is restricted to repair or replacement by Smith & Nephew Endoscopy, at its option, of any product found to be defective during the warranty period. Damage inflicted to a product by the user will result in additional charges and may void the warranty. This includes, but is not limited to, normal use-related damage, any attempted repairs by unauthorized service providers, using a sterilization method not approved by Smith & Nephew Endoscopy, and using the product in a way that is not intended by Smith & Nephew Endoscopy. All warranties apply to the original buyer only and are not transferable. In no event shall Smith & Nephew Endoscopy be liable for any anticipated profits, consequential damages, or loss of time incurred by the buyer with the purchase or use of any product.

### Made to Order (MTO) Instruments:

We will accept orders for Made To Order (MTO) instruments. All Made To Order (MTO) sales are final. Service agreements are not available on MTO or custom products. These products are serviced on a repair only basis.

### Minimum Order:

The minimum order amount is \$50 for sales orders and \$20 for service orders.

Smith & Nephew Endoscopy products are offered exclusively through authorized representatives. For the name and address of your local representative, contact our Customer Service Department.

Sales personnel may not alter the above terms, extend credit, or accept payment for merchandise.

**Customer Service Phone:** 1-800-343-5717 (Available 8 am–6 pm EST), **Customer Service Fax:** 1-800-554-6105

**Option 1:** Orders, **Option 2:** Technical Support, **Option 3:** Returns, Repairs, Service Exchanges, **Option 9:** Emergency Technical Assistance  
Smith & Nephew Endoscopy, 150 Minuteman Road, Andover, Massachusetts 01810, U.S.A.



## Trademarks

All trademarks acknowledged. The following are trademarks of Smith & Nephew:

ABLATOR <sup>®</sup>	ENDO-FIX <sup>®</sup>	RAPTORMITE <sup>®</sup>
ACCU-PASS <sup>®</sup>	EP-1 <sup>®</sup>	RAZORCUT <sup>®</sup>
ACROMIOBLASTER <sup>®</sup>	FAST-FIX <sup>®</sup>	ROTORLOC <sup>®</sup>
ACUFEX <sup>®</sup>	FLUORO-SHIELD <sup>®</sup>	SAPHYRE <sup>®</sup>
ACUFEX DUCKBILL <sup>®</sup>	FOOTPRINT <sup>®</sup>	SCOPEASSURED <sup>®</sup>
ACUTHERM <sup>®</sup>	GORE SMOOTHER <sup>®</sup>	SCULPTOR <sup>®</sup>
AGILE-CARE <sup>®</sup>	GRAFTMASTER <sup>®</sup>	SERVICE IQ <sup>®</sup>
ALLOGRAFTANCHOR <sup>®</sup>	HELICUT <sup>®</sup>	SILK ESCORT <sup>®</sup>
ARTHROGARDE <sup>®</sup>	INCISOR <sup>®</sup>	SOFTSILK <sup>®</sup>
ARTHRO-PIERCE <sup>®</sup>	INCISOR <sup>®</sup> PLUS	SPYROMITE <sup>®</sup>
AUTO SHUTTER COMMON LAW <sup>®</sup>	INTELIJET <sup>®</sup>	STINGRAY <sup>®</sup>
AUTOTEMP <sup>®</sup>	INTERCEPTRE <sup>®</sup>	STONECUTTER <sup>®</sup>
BACK DESIGN <sup>®</sup> (human form)	ISO-PAC <sup>®</sup>	SURETAC <sup>®</sup>
BIORAPTOR <sup>®</sup>	ISO-TAC <sup>®</sup>	SURGICAL ASSISTANT <sup>®</sup>
BIORCI <sup>®</sup>	KINSA <sup>®</sup>	SURILLIUM <sup>®</sup>
BIOSURE <sup>®</sup>	LEVELERT <sup>®</sup>	SYNOVATOR <sup>®</sup>
BONECUTTER <sup>®</sup>	LIGAMENT CHISEL <sup>®</sup>	T-FIX <sup>®</sup>
CANNU-FLEX <sup>®</sup>	MACROFRACTURE <sup>®</sup>	TAG <sup>®</sup>
CANNU-FLEX SILK <sup>®</sup>	MEDFLO <sup>®</sup>	TRAILBLAZER <sup>®</sup>
CARTOGEN <sup>®</sup>	MICRO VECTOR <sup>®</sup>	TRU <sup>®</sup>
CLEAR-TRAC <sup>®</sup>	MINITAC <sup>®</sup>	TRUBLOCK <sup>®</sup>
CLEAR-TRAC <sup>®</sup> COMPLETE	MINI-TAG <sup>®</sup>	TRUFIT <sup>®</sup>
CLOUD 9 <sup>®</sup>	MOSAICPLASTY <sup>®</sup>	TRUGRAFT <sup>®</sup>
CONDOR <sup>®</sup>	MULTI-TRAC <sup>®</sup>	TRUKOR <sup>®</sup>
CONDOR EXPRESS <sup>®</sup>	NEM <sup>®</sup>	TRUREPAIR <sup>®</sup>
CROSSTRAC <sup>®</sup>	NAVITAR <sup>®</sup>	TRURESCUE <sup>®</sup>
CUFF STITCH <sup>®</sup>	NEEDLESCOPE <sup>®</sup>	TRUREVISION <sup>®</sup>
DURABRAID <sup>®</sup>	NEOCYTE <sup>®</sup>	TRUSOLUTION <sup>®</sup>
DYNAMITE <sup>®</sup>	NOTCHBLASTER <sup>®</sup>	TRUWEDGE <sup>®</sup>
DYOBRITE <sup>®</sup>	NOTCHMASTER <sup>®</sup>	TURBOCUTTER <sup>®</sup>
DYONICS <sup>®</sup>	OBI <sup>®</sup>	TURBOTRIMMER <sup>®</sup>
DYONICS <sup>®</sup> ARTHROPAK <sup>®</sup>	OBI DEVICE <sup>®</sup>	TURBOWHISKER <sup>®</sup>
DYONICS <sup>®</sup> EP-1 <sup>®</sup>	ORA-50 <sup>®</sup>	TWINFIX <sup>®</sup>
DYONICS <sup>®</sup> POWER <sup>®</sup>	ORBIT <sup>®</sup>	ULTRABRAID <sup>®</sup>
EAS <sup>®</sup>	OSTEORAPTOR <sup>®</sup>	VULCAN <sup>®</sup>
ECTRA <sup>®</sup>	PHOENIX <sup>®</sup> 5.0	VECTOR <sup>®</sup>
EFLEX <sup>®</sup>	POLYGRAFT <sup>®</sup>	WHIPKNOT <sup>®</sup>
ELECTROBLADE <sup>®</sup>	POWERMAX <sup>®</sup>	
ELECTROTHERMAL <sup>®</sup>	PRO-TRAC <sup>®</sup>	
ELITE <sup>®</sup>	PS3500EP <sup>®</sup>	
ELITE SHOULDER SYSTEM <sup>®</sup>	RAP-PAC <sup>®</sup>	
ENDOBUTTON <sup>®</sup>	RAPTOR <sup>®</sup>	

## Patents

These products are covered by one or more of the following patents:

U.S. Patent No. 4,203,444; 4,300,565; 4,655,752; 4,662,371; 4,669,473; 4,705,038; 4,712,545; 4,722,331; 4,741,330; 4,779,616; 4,781,183; 4,834,729; 4,842,578; 4,953,753; 4,969,450; 4,983,179; 5,010,876; 5,029,573; 5,035,695; 5,037,422; 5,041,129; 5,056,902; 5,076,431; 5,077,506; 5,100,417; 5,116,337; 5,133,729; 5,139,499; 5,139,520; 5,152,744; 5,152,763; 5,163,940; 5,192,287; 5,224,946; 5,234,430; 5,236,445; 5,258,015; 5,258,016; 5,261,914; 5,269,809; 5,270,622; 5,277,696; 5,290,282; 5,306,301; 5,312,438; 5,318,582; 5,320,635; 5,322,505; 5,324,301; 5,325,883; 5,336,225; 5,346,503; 5,356,419; 5,364,400; 5,366,477; 5,374,269; 5,380,334; 5,383,878; 5,400,805; 5,417,691; 5,423,819; 5,423,860; 5,437,675; 5,443,468; 5,454,811; 5,456,685; 5,458,596; 5,464,425; 5,496,326; 5,505,736; 5,510,070; 5,514,130; 5,522,843; 5,522,844; 5,549,676; 5,563,481; 5,569,242; 5,569,303; 5,571,195; 5,575,757; 5,590,570; 5,593,416; 5,601,558; 5,601,583; 5,602,449; 5,618,293; 5,620,415; 5,620,447; 5,621,830; 5,628,766; 5,630,798; 5,630,799; 5,630,826; 5,643,203; 5,643,302; 5,643,303; 5,645,588; 5,653,716; 5,662,611; 5,667,513; 5,672,945; 5,681,314; 5,687,742; 5,688,276; 5,690,659; 5,690,676; 5,690,678; 5,693,060; 5,695,522; 5,702,401; 5,707,350; 5,712,543; 5,718,706; 5,720,766; 5,727,428; 5,728,100; 5,730,747; 5,740,801; 5,741,281; 5,743,914; 5,745,647; 5,749,885; 5,755,731; 5,759,189; 5,769,894; 5,782,834; 5,782,924; 5,785,705; 5,792,182; 5,797,836; 5,804,936; 5,808,813; 5,817,095; 5,823,994; 5,833,692; 5,840,060; 5,842,477; 5,864,359; 5,871,493; 5,873,884; 5,882,339; 5,893,858; 5,893,874; 5,897,560; 5,899,907; 5,902,741; 5,906,577; 5,908,426; 5,913,867; 5,919,702; 5,921,956; 5,928,240; 5,928,945; 5,931,844; 5,935,149; 5,947,982; 5,947,990; 5,954,716; 5,957,836; 5,957,953; 5,961,521; 5,961,535; 5,964,696; 5,964,777; 5,968,050; 5,976,127; 5,980,504; 5,986,271; 5,989,247; 6,004,320; 6,007,533; 6,007,561; 6,007,570; 6,022,356; 6,030,400; 6,036,695; 6,042,573; 6,045,561; 6,048,354; 6,051,006; 6,056,752; 6,060,306; 6,068,604; 6,068,628; 6,073,051; 6,086,591; 6,086,592; 6,086,608; 6,090,122; 6,095,149; 6,099,514; 6,102,934; 6,117,161; 6,120,541; 6,121,042; 6,122,549; 6,123,710; 6,126,682; 6,129,661; 6,132,442; 6,135,999; 6,139,583; 6,146,385; 6,146,406; 6,149,654; 6,162,217; 6,168,593; 6,176,857; 6,187,011; 6,200,329; 6,214,001; 6,221,107; 6,231,606; 6,235,057; 6,246,913; 6,258,086; 6,261,311; 6,283,960; 6,290,715; 6,295,082; 6,328,752; 6,336,940; 6,350,262; 6,352,544; 6,355,053; 6,358,253; 6,358,273; 6,375,658; 6,379,350; 6,387,110; 6,436,116; 6,440,141; 6,443,963; 6,450,992; 6,451,030; 6,461,353; 6,461,357; 6,482,204; 6,482,210; 6,511,488; 6,517,568; 6,533,802; 6,537,278; 6,544,260; 6,547,810; 6,551,279; 6,583,232; 6,599,289; 6,620,185; 6,623,492; 6,638,276; 6,689,153

## Returned Goods Policy

### Outside the U.S.:

Please contact your local authorized Smith & Nephew Endoscopy representative.

### In the U.S.:

This policy supports all transactions that occur within the United States. Smith & Nephew Endoscopy will repair or replace, at its discretion, products that have not been obsoleted, discontinued or found to have manufacturing or material defects within the warranty period. Customers will be billed for misuse and abuse. Warranties apply only to the original buyer.

Reason	Warranty Expiration Date	Packaging Requirements	Restocking Fee	Customer Freight Charge In/Out
Ordered incorrectly Overstocked product	30 Days	Original	No	Yes/Yes
Ordered incorrectly Overstocked product	31-60 Days	Original	Yes	Yes/Yes
Warranty of product repaired or exchanged within original warranty	Product Line	N/A	No	Yes/No
Warranty of product repaired or exchanged after original warranty	90 Days	N/A	No	Yes/No
Incorrect product shipped from Smith & Nephew Endoscopy	30 Days	Original	No	No/No
Program incentive	Program	N/A	No	Program
New product failures	30 Days	Original	No	No/No

### Conditions:

The warranty period begins on the original invoice date.

Requests for credit returns must be received within 60 days of invoice date.

A Return Authorization Number (R.A. Number) is required to return product. Smith & Nephew Endoscopy will issue the R.A. Number

Restocking fee is 20% of product value invoiced.

Credit cannot be given for items damaged in return shipment due to inadequate packaging.

Customers will be billed for non-returns after 30 days of shipped replacement product.

To receive full credit, all products must be returned in full package quantities.

90 day warranty on repairs only applies to the defective component repaired.

Note: Returned product that is found to have been serviced by unauthorized service providers, sterilized using a method not approved by Smith & Nephew Endoscopy or used in a way that is not intended by Smith & Nephew Endoscopy will incur additional costs, regardless of warranty or service agreement status.

## Smith & Nephew AGILE-CARE<sup>®</sup> Instrument Services

For the highest quality service and proven performance, choose Smith & Nephew's AGILE-CARE Instrument Services. As an FDA inspected, ISO 9001 certified manufacturer, only Smith & Nephew has the proprietary parts and knowledge to maintain your equipment to the original factory condition. Smith & Nephew has over 30 years of service experience, processing over 60,000 equipment repairs and 50,000 technical support calls each year. In fact, over 98% of all issues are resolved within 24 hours. Maximize the performance and life of your equipment by using AGILE-CARE Instrument Services.

### Benefits

#### Responsiveness and uptime

AGILE-CARE Instrument Services resolves issues within 24 hours with technical phone support, on-site service and factory based service.

#### Flexibility

AGILE-CARE Instrument Services has a full range of services to meet your needs; from 24 hour service exchange to dedicated on-site service.

#### Ease of administration

AGILE-CARE Instrument Services provides one number to call and comprehensive service agreements to minimize your administrative complexity and paperwork.

#### Clinical performance

AGILE-CARE Instrument Services quality keeps your equipment in like-new condition with clear images helping you deliver better patient care.

#### Cost savings

AGILE-CARE Instrument Services provides "Wear and Tear" protection and the highest quality service. This minimizes repeat repairs and results in real cost savings.

### Programs

#### AGILE-CARE Factory Service

Replacement Plan  
Service Exchange  
SCOPEASSURED<sup>®</sup>  
Repair

#### AGILE-CARE On-Site Service\*

Dedicated Plan  
Standard Plan  
Preventive Plan  
Per-Incident



\* Check with your sales representative for local availability

## AGILE-CARE<sup>◇</sup> Factory Service

Smith & Nephew expertly services your equipment at our FDA inspected, ISO 9001 certified facilities. The following are “return to factory” based services ranging from service agreements to per-incident service. Please contact your Smith & Nephew sales representative for more information. Some countries may not offer these programs. Factory-based services utilize the Return Authorization (RA) process. See page iv for details.

### Replacement Plan

The Replacement Plan is a service agreement that provides product replacement coverage for up to four years at a fixed price. Features include:

- Products are exchanged within 24 hours during normal business hours
- Coverage includes “Wear and Tear” protection. This covers use-related damage (front-end of scope is clipped)
- Available on new and existing products
- One purchase order provides coverage for an extended period of time
- Invoices can be monthly, quarterly or annual
- Software updates

**Conditions:** Standard terms and conditions for the Service Agreements apply. Products to be covered must be in good working condition and not previously repaired by a non-authorized third party. Products are subject to inspection prior to coverage being extended. For a quotation in the US, please contact your Smith & Nephew Endoscopy sales representative.

### Service Exchange

This service provides product replacement on a per-incident basis. Features include:

- Products are exchanged within 24 hours during normal business hours
- Fixed price per exchange event

### SCOPEASSURED<sup>◇</sup>

This scope-only service provides scope replacement on a per-incident basis. Features include:

- Scopes are exchanged within 24 hours during normal business hours
- Four price levels depending upon the level of damage

### Repair

This per-incident service is for customized products not available for service exchange. Features include:

- Expert evaluation and quotation. (Declined quotations will be assessed a nominal evaluation fee)
- Repairs done within 72 hours after your quote approval

## AGILE-CARE<sup>◇</sup> On-Site Service

Factory trained Smith & Nephew technicians provide maintenance and value-added services at your facility for your Endoscopic and Digital OR services. Please contact your Smith & Nephew sales representative for more information and availability. Some countries may not offer these programs.

### Dedicated Plan

For facilities that require immediate issue resolution to maximize equipment utilization and OR uptime. Features include:

- Full-time factory trained technicians at your facility
- Immediate troubleshooting, preventive maintenance and staff training
- Can be combined with Replacement Plan service

### Standard Plan

For facilities that demand 24-hour issue resolution. Features include:

- Local service technicians provide all-inclusive service and replacement products
- Quarterly, comprehensive preventive maintenance
- Fixed annual price can be locked in for up to four years and includes parts, labor and travel

### Preventive Plan

For facilities that want quarterly PM's performed by our factory trained technicians. Features include:

- Helps prevent equipment failures and reduces life cycle repair costs
- Can be combined with Replacement Plan service
- Fixed annual price can be locked in for up to four years and includes limited parts, labor and travel

### Per-Incident

For facilities that prefer the flexibility of "pay as you go" parts and labor. Features include:

- Available for troubleshooting, same-day replacements and preventive maintenance

## Service Program Notations

### Eligibility

The following items are not eligible for Repair: Any consumable or disposable products such as light guides, lamps, cords, batteries, blades and tube sets.

In addition to the above items, the following items are not eligible for Service Exchange or Replacement Plan: Made to Order or custom products, products beyond their designated service life, ACUFEX<sup>®</sup> instruments, cannulas, obturators, trocars, products serviced by unauthorized third parties, products sterilized by a method not approved by Smith & Nephew, or products used in a way not intended by Smith & Nephew.

### Return Authorization Process

This process is used for all service exchanges and repairs. To initiate this process in the US, call 1-800-343-5717. Press option 3 for Returns, Repairs and Service Exchanges and provide the following information. For next day service exchange, your call must be made before 4pm EST.

- Your Smith & Nephew customer number
- Purchase order number
- Model and serial number
- Fax and phone number

Smith & Nephew will issue a Return Authorization Number (RA#). To ensure proper receipt of your defective unit, please include correspondence identifying the problem, the RA# and clearly mark the shipping container with the RA#. Include your decontamination certificate. Ship to the appropriate Service Center as instructed (or listed on page x. If this is a Service Exchange or SCOPEASSURED<sup>®</sup>, and the defective unit is not received within 30 days, an invoice will be issued for the difference between the list price of a new unit and the service replacement price.

### SCOPEASSURED<sup>®</sup> Levels

Under the SCOPEASSURED program, each scope is evaluated and classified within one of four damage levels.

**Level 1:** Replacement of distal lens on non-autoclavable endoscopes, fiber polish at distal and light post ends, repair light post damage, removal of deposits on distal and proximal windows.

**Level 2:** All of the above plus repair or replace broken or loose internal optics, replacement of rear window, repair of leaking eyepiece or video-endoscope housing, replacement of distal lens on autoclavable endoscopes

**Level 3:** All of the above plus major damage to the needle assembly (ex: bent, severe front-end damage)

**Level 4:** Damage beyond repair through misuse or unauthorized third party repair.

### Serial Numbers

Service agreements require valid serial numbers to be supplied by customer before an agreement can be activated.

### Standard Warranty versus Service Agreement

Standard warranty on products is for a limited time and covers only manufacturing defects. Coverage for "use-related" damage during and after standard warranty is available through a service agreement.



## Service Centers

Country	Phone Number	Service Center Address
Australia	0011-61-7-3846-7800	Smith & Nephew Surgical Pty. Ltd Service Centre 188 Vulture Street South Brisbane QLD 4101 Australia
Brazil	011-5511-5586-3255	PCE-Pro Cirurgia Especializada Ltda. Rua Itapiru, 137 São Paulo, -SP - 04143-010 Brasil
Canada	905-813-7770	Smith & Nephew Canada 6685 Millcreek Drive Mississauga, ON L5N 5M5
Germany	011-49-746-2208317	Smith & Nephew GMBH Service Center Gaensaecker 27 D-78532 Tuttlingen Germany
Japan	011-81-3-5403-8671	Smith & Nephew KK daVinci SHIBA PARK A-3F 2-4-1 Shiba-Koen MINATO-KU Tokyo 105-0011, Japan
UK	011-44-1480-423240	Smith & Nephew Endoscopy Endoscopy House Cardinal Park Godmanchester, Huntingdon, PE29 2SN United Kingdom
US	1 800 343 5717 1 978 749 1000	Smith & Nephew, Inc Endoscopy 76 S Meridian Avenue Oklahoma City, OK 73107-6512

**Attention:** Use of reprocessed, single-use blades may permanently damage, impede performance or cause failure of your Arthroscopic Shaver System. Use of such products may render any warranties null and void.

## New Product Warranty

The following warranty terms are in effect at time of catalog publication. Smith & Nephew reserves the right to modify any of the warranty terms below. For the latest warranty information, it is best to contact Smith & Nephew directly.

Description	New Product Warranty
<b>CORDLESS INSTRUMENTS</b>	
450 Drill	1 Year
Sagittal Saw	1 Year
800 Wire Driver	1 Year
MPC IV Charger	1 Year
PAC II Battery	30 Days
<b>SHAVER COMPONENTS</b>	
DYONICS® Power Control Units	2 Years
DYONICS Power Motor Drive Units	2 Years
DYONICS Power Footswitches	2 Years
DYONICS Power Corded Drill and Saw	1 Year
DYONICS POWERMAX® Motor Drive	180 Days
<b>VISUALIZATION PRODUCTS</b>	
CONDOR® Control System	1 Year
<b>COUPLERS</b>	
BEAMSPLITTERS	1 Year
LIGHT GUIDES	90 Days
VERSITIPS	90 Days
<b>INSUFFLATORS</b>	
IN-LINE GAS WARMER/HUMIDIFIER	90 Days
<b>ACCESS 15 ARTHROSCOPIC FLUID IRRIGATION SYSTEM</b>	
<b>VULCAN® GENERATOR</b>	
Footswitch	1 Year
<b>ACUFEX® HAND INSTRUMENTS</b>	
VIDEO MONITORS, PRINTERS, and VCR's	1 Year
HP PRINTERS	90 Days
<b>CANNULAS, OBTURATORS, and TROCARS</b>	
INTERCEPTRE® INSTRUMENTS	1 Year
<b>STERILIZATION TRAYS and CARTS</b>	
	1 Year

## Service Replacement and Repair Warranty

All service replacement and repairs have a 90 day limited warranty

**Notes:** 90 day warranty on repairs only applies to the defective component repaired. Product returned that is found to have been serviced by unauthorized service providers, sterilized using a method not approved by Smith & Nephew Endoscopy or used in a way that is not intended by Smith & Nephew Endoscopy incur additional costs, regardless of warranty or service agreement status.

† Warranted to be free from defects in material and workmanship for their lifetime against failure in normal use.

**Attention:** Use of reprocessed, single-use blades may permanently damage, impede performance or cause failure of your Arthroscopic Shaver System. Use of such products may render any warranties null and void.

## International Contacts

### Smith & Nephew Group Companies

Country	Telephone
Australia	61-2-9857-3999
Austria	43-1-7079102
Belgium	32-2-702-2911
Canada	1-877-977-1772/1-905-813-7770
Central European Office	43-170-79102
P. R. China	86-21-6350-3100
Denmark	45-4580-6100
EDSC	33-148-64-78-84
Finland	358-010-218-7300
France	33-2-43-83-23-23
Germany	49-407-07-000
Netherlands	31-206543999
Hong Kong	852-2648-7700
India	91-22-4005-5090
Indonesia	62-21-5555 807/809/794
Ireland	353-1217-0444
Italy	39-039-60941
Japan	81-3-5443-5345
Korea	822-6001-7575
Malaysia	603-7958-7103
Mexico	525-628-0211
U. A. E.	971-4311-6300
New Zealand	64-9-828-4059
Norway	47-66-842020
Pakistan	92-21-256-1176
Philippines	632-575-4419
Portugal	351-1-446-0650
Puerto Rico	1-787-764-5115
Singapore	65-6-270-0552
South Africa	27-31-242-8111
Spain	34-93-373-7301
Sweden	46-31-746-5800
Switzerland	41-32-624-5660
Taiwan	886-22698-9711
Thailand	662-719-6227 or 6221
United Kingdom	01480-423200
United States	1-800-749-1000

## International Contacts

### Smith & Nephew Endoscopy Distributors

Country	Distributor	Telephone
Argentina	Droguería Martorani S.A.	(54 11) 4554-8100
Brazil	PCE	55115586-3255
Chile	Arenys Med	56-2-333-4437
Egypt	Horizon	202-2402-712
Greece	N. Carayannis Orthopaedic SA	30-210-6254900
Israel	Tradis Gat Ltd.	972-3-923-3345
Sri Lanka	Chemical Industries (Colombo Ltd.)	941-328-421-6
Turkey	Plato Grup	0212-284-6434
Venezuela	Eurociencia C.A.	58212-7007901

## Smith & Nephew Endoscopy Financial Services

As a turnkey acquisition strategy for all Smith & Nephew Endoscopy products and services, we address the complexities that healthcare administrators face in today's market by offering the expertise to assist you in your effort to deliver the highest quality patient care in the most affordable way possible. Please call us for more information: 866-523-3278.

### Financial Benefits

#### Flexibility

As your business grows and your needs change, you can add or upgrade at any point during the term through add-on schedules. You also have the option to include service contracts.

#### Upgraded technology

The healthcare industry demands that you have the latest technology, so a short-term operating lease can help you get the equipment and keep your cash. Your risk of getting caught with obsolete equipment is lower because you can upgrade or add equipment to meet your ever-changing needs.

#### Flexible end-of-term options

There are several options for disposing of equipment after the lease term ends, including returning the equipment, renewing the lease, or purchasing the equipment.

#### 100% financing

Since a lease does not require a down payment, it is equivalent to 100% financing, which means you have more money to invest in revenue-generating activities.

#### Customized solutions

A variety of products are available, allowing you to tailor a program to fit your month-to-month or year-to-year cash flow needs. You are able to customize a program to address your needs and requirements, e.g., cash flow, budget, transaction structure, cyclical fluctuations.

### Financial Programs

#### Cost-Per-Case Program

A program where you pay for the equipment as you use it. The cost-per-case expense can be applied to your operating budget, thereby freeing up capital budget dollars.

#### Cost-Per-Consumable Program

A program that enables you to standardize your OR with all Smith & Nephew Endoscopy products. An upcharge that covers the equipment you wish to acquire is applied to your consumables.

#### Fixed-Cost Financing Program

A fixed cost for the equipment you wish to acquire is invoiced monthly for your desired term. The fixed cost may be treated as an operating expense, thereby freeing up capital budget dollars. Consult with your accounting professional for advice.

#### Customized Program

Smith & Nephew Endoscopy will design a program tailored to meet your specific needs:

- Operating Leases

- Capital Leases

- Deferred Payment Program

- Step Up Lease Program

- Seasonal Cash Flow Lease Program

# A

TRUREPAIR Solutions .....A-1

## TRUREPAIR<sup>®</sup> Solutions

### Product Highlights



#### TRUREPAIR Solutions

Smith & Nephew TRUREPAIR devices provide a resorbable scaffold and related instrumentation for the repair and replacement of bone. TRUREPAIR devices are made from proprietary POLYGRAFT<sup>®</sup> technology—a completely synthetic composite material that is biologically friendly and biomechanically stable.

The TRUREPAIR product family includes TRUFIT<sup>®</sup> BGS Plugs, TRUGRAFT<sup>®</sup> Syringes and Granules, TRUWEDGE<sup>®</sup> implants and TRUBLOCK<sup>®</sup> implants.

## Tissue Repair

### TRUREPAIR® Product line

The Smith & Nephew TRUREPAIR product line provides porous structural, bioresorbable scaffolds uniquely designed for the repair and replacement of bone.

Smith & Nephew is focused on developing Innovative Tissue Repair Solutions for sports medicine indications. Utilizing a proprietary combination of polymers, ceramics, and fibers, the material is designed to be a highly porous scaffold to support bone incorporation and remodeling, it's biomechanically sound during the time required for healing and it's biologically friendly by absorbing biologic fluids and nutrients. As innovators in tissue repair, Smith & Nephew will continue to develop products designed to reduce patient morbidity and improve patient outcomes.

Our products include the TRUFIT® BGS Plugs for use in filling bony voids or gaps caused by trauma or surgery that are not intrinsic to the stability of the bony structure. TRUKOR® Plus Instruments for the preparation of precise circular sites for the TRUFIT BGS Plug. TRUGRAFT® BGS Syringe to offer a more convenient means of delivering TRUGRAFT BGS Granules into bone void sites with limited accessibility.

### TRUGRAFT BGS Granules and Syringe



REF	Description
72200919	TRUGRAFT BGS Granules, 10 cc (2 g)
72200920	TRUGRAFT BGS Granules, 30 cc (6 g)
72200921	TRUGRAFT BGS Syringe, 5 cc (1 syringe per package)
72200922	TRUGRAFT BGS Syringe, 10 cc (2 syringe per package)

### TRUFIT BGS Plug Kits (Plug, Delivery Device, Trimming Knife)

The safety and effectiveness of this device for use in osteochondral defects have not been established.



REF	Description
72200923	TRUFIT BGS Plug – Size Code Green, 5 mm
72200924	TRUFIT BGS Plug – Size Code Yellow, 6 mm
72200925	TRUFIT BGS Plug – Size Code Red, 7 mm
72200926	TRUFIT BGS Plug – Size Code Tan, 7.5 mm
72200927	TRUFIT BGS Plug – Size Code Blue, 9 mm
72200928	TRUFIT BGS Plug – Size Code Orange, 9.5 mm
72200929	TRUFIT BGS Plug – Size Code Purple, 11 mm
72200948	TRUFIT Ruler



## TRUREPAIR<sup>®</sup> Solutions

### TRUKOR<sup>®</sup> Plus Instruments



REF	Description
72200965	TRUKOR Plus Site Preparation Kit (Contains Sterilization Tray, Drills, Universal Drill Handle, Caps, Sizers, Depth Gauge, Obturators)
72200964	TRUKOR Plus Instrument Sterilization Tray
72200954	TRUKOR Plus Drill – Size Code Green, 5 mm
72200955	TRUKOR Plus Drill – Size Code Red, 7 mm
72200956	TRUKOR Plus Drill – Size Code Blue, 9 mm
72200957	TRUKOR Plus Drill – Size Code Purple, 11 mm
72200962	TRUKOR Plus Universal Drill Handle
72200941	TRUKOR Drill Sleeve Cap – Size Code Green, 5 mm
72200942	TRUKOR Drill Sleeve Cap – Size Code Red, 7 mm
72200943	TRUKOR Drill Sleeve Cap – Size Code Blue, 9 mm
72200944	TRUKOR Drill Sleeve Cap – Size Code Purple, 11 mm
72200949	TRUKOR Obturator – Size Code Green, 5 mm
72200950	TRUKOR Obturator – Size Code Red, 7 mm
72200951	TRUKOR Obturator – Size Code Blue, 9 mm
72200952	TRUKOR Obturator – Size Code Purple, 11 mm
72200958	TRUKOR Plus Sizer – Size Code Green, 5 mm
72200959	TRUKOR Plus Sizer – Size Code Red, 7 mm
72200960	TRUKOR Plus Sizer – Size Code Blue, 9 mm
72200961	TRUKOR Plus Sizer – Size Code Purple, 11 mm
72200963	TRUKOR Plus Depth Gauge

### TRUKOR<sup>®</sup> Instruments - Drill Sleeves



REF	Description
72200937	TRUKOR Drill Sleeve – Size Code Green, 5 mm, disposable
72200938	TRUKOR Drill Sleeve – Size Code Red, 7 mm, disposable
72200939	TRUKOR Drill Sleeve – Size Code Blue, 9 mm, disposable
72200940	TRUKOR Drill Sleeve – Size Code Purple, 11 mm, disposable

## TRUREPAIR<sup>®</sup> Solutions

### TRUBLOCK<sup>®</sup> BGS



REF	Description
72200967	TRUBLOCK BGS – 15 mm X 15 mm X 20 mm
72200968	TRUBLOCK BGS – 20 mm X 20 mm X 20 mm
72200969	TRUBLOCK BGS – 25 mm X 25 mm X 20 mm

### TRUWEDGE<sup>®</sup> BGS (Length 40 mm, Width 15 mm)



72200970	TRUWEDGE BGS – 7.5 mm (Height), 7.5°
72200971	TRUWEDGE BGS – 10 mm (Height), 10°
72200972	TRUWEDGE BGS – 12.5 mm (Height), 12.5°
72200973	TRUWEDGE BGS – 15 mm (Height), 15°
72201026	TRUWEDGE BGS – 5 mm (Height), 5°

The TRUFIT<sup>®</sup> CB products are indicated for cartilage and bone repair. These products are *not* available for distribution in the United States and its territories.

### TRUFIT CB Plug Kits (Plug, Delivery Device, Trimming Knife)



72200930	TRUFIT CB Plug – Size Code Green, 5 mm
72200931	TRUFIT CB Plug – Size Code Yellow, 6 mm
72200932	TRUFIT CB Plug – Size Code Red, 7 mm
72200933	TRUFIT CB Plug – Size Code Tan, 7.5 mm
72200934	TRUFIT CB Plug – Size Code Blue, 9 mm
72200935	TRUFIT CB Plug – Size Code Orange, 9.5 mm
72200936	TRUFIT CB Plug – Size Code Purple, 11 mm

### TRUFIT CB Angle Plugs (Plug, Delivery Device, Trimming Knife)



72201014	TRUFIT CB Angle Plug, Size Code Green, 5 mm
72201015	TRUFIT CB Angle Plug, Size Code Red, 7 mm
72201016	TRUFIT CB Angle Plug, Size Code Blue, 9 mm

### TRUFIT CB Saddle Plugs (Plug, Delivery Device, Trimming Knife)

72201909	TRUFIT CB Saddle Plug, Size Code Blue, 9 mm
72201910	TRUFIT CB Saddle Plug, Size Code Purple, 11 mm

# B

## Arthroscopes

VideoArthroscopes, Autoclavable .....	B-1
VideoArthroscopes, Non-Autoclavable .....	B-2
Direct-View Arthroscopes .....	B-4
Direct-View Arthroscopes, Autoclavable .....	B-4
Direct-View Arthroscopes, Non-Autoclavable .....	B-4
Specialty Endoscopes (ECTRA® II) and Accessories .....	B-5
Made to Order .....	B-6

## VideoArthroscopes, Autoclavable



Indications: Arthroscopy and examination/treatment of nasal cavities and nasal pharynx

Wide-angle lens design for a larger field-of-view

Unparalleled brightness

Sharp images throughout the entire field-of-view

Lightweight construction

Sapphire lenses for improved scratch resistance over conventional glass

Epoxy-free proprietary seal design guarantees leak-free multiple sterilization modality

Compatible with Smith & Nephew autoclavable Camera Heads

Validated for both steam and chemical (EtO, Steris®, and Sterrad®) sterilization modalities

REF	Outer Diameter	Direction of View	Field of View	Working Length	Light Post Direction	Cannula Connection	Recommended Light Cable
VideoArthroscopes, Autoclavable, High Definition 560H only							
72200312	4.0 mm	30°	115°	160 mm	Opposite	J-Lock	5.0 mm
72200089	4.0 mm	70°	115°	160 mm	Opposite	J-Lock	5.0 mm

REF	Outer Diameter	Direction of View	Field of View	Working Length	Light Post Direction	Cannula Connection	Recommended Light Cable
VideoArthroscopes, Autoclavable, 470H head, Smith & Nephew mount							
7210716	4.0 mm	30°	115°	160 mm	Opposite	J-Lock	5.0 mm
7209401	4.0 mm	70°	115°	160 mm	Opposite	J-Lock	5.0 mm
7209402	2.7 mm	30°	90°	120 mm	Opposite	J-Lock	4.0 mm
7205929	2.7 mm	30°	90°	67 mm	Opposite	J-Lock	4.0 mm

REF	Description
7205548	Aluminum oxide vial for cleaning autoclavable endoscope lenses
7210721	Protective cap for autoclavable scopes. Fits 4.0 mm and 5.5 mm scopes. Package of 70.

Note: These VideoArthroscopes for use only with Smith & Nephew Autoclavable Camera Heads

## VideoArthroscopes, Non-Autoclavable



Indications: Arthroscopy and examination/treatment of nasal cavities and nasal pharynx

Stainless steel construction to withstand chemical sterilization modalities (EtO, Steris®, and Sterrad®)

Wide angle of view

Ergonomically designed to directly attach to the camera head for ease of use

Insertion needle is fully rotatable without the need to reposition the camera head

Compatible with Smith & Nephew Non-Autoclavable Camera Heads (C-Mount), as listed below

REF	Outer Diameter	Direction of View	Field of View	Working Length	Light Post Direction	Cannula Connection	Recommended Light Cable
-----	----------------	-------------------	---------------	----------------	----------------------	--------------------	-------------------------

### Black Focus Ring, 19.5 mm focal length

Note: These VideoArthroscopes, non-autoclavable HD for use only with the Smith & Nephew 560H camera heads only.

72201501	4.0 mm	30°	115°	160 mm	Opposite	J-Lock	5.0 mm
72201671	4.0 mm	70°	115°	160 mm	Opposite	J-Lock	5.0 mm
72201689	4.0 mm	30°	115°	160 mm	Same Side	J-Lock	5.0 mm

REF	Outer Diameter	Direction of View	Field of View	Working Length	Light Post Direction	Cannula Connection	Recommended Light Cable
-----	----------------	-------------------	---------------	----------------	----------------------	--------------------	-------------------------

### Blue Focus Ring, 35 mm focal length

7205922*	4.0 mm	30°	115°	160 mm	Opposite	J-Lock	5.0 mm
3766	4.0 mm	30°	115°	160 mm	Same Side	J-Lock	5.0 mm
3628	4.0 mm	70°	115°	160 mm	Opposite	J-Lock	5.0 mm
3632	2.7 mm	30°	90°	120 mm	Opposite	J-Lock	4.0 mm
3768	2.7 mm	30°	90°	67 mm	Opposite	J-Lock	4.0 mm
3863	1.9 mm	30°	75°	65 mm	Opposite	J-Lock	2.0 mm

Note: These VideoArthroscopes for use only with the Smith & Nephew ED3, 360, 460, HD900, and 111 camera heads.

Not compatible with the Smith & Nephew 470 or 560 camera heads

REF	Description
8001701	Replacement O-ring for C-mount Video Arthroscopes

\* Item shown

## VideoArthroscopes, Non-Autoclavable



Indications: Arthroscopy and examination/treatment of nasal cavities and nasal pharynx

Stainless steel construction to withstand sterilization modalities (EtO, Steris®, and Sterrad®)

Wide angle of view

Ergonomically designed to directly attach to the camera head for ease of use

Insertion needle is fully rotatable without the need to reposition the camera head

Compatible with Smith & Nephew Non-Autoclavable Camera Heads (C-Mount)

REF	Outer Diameter	Direction of View	Field of View	Working Length	Light Post Direction	Cannula Connection	Recommended Light Cable
4125	4.0 mm	30°	115°	160 mm	Opposite	J-Lock	5.0 mm
4126	4.0 mm	70°	115°	160 mm	Opposite	J-Lock	5.0 mm
4130*	2.7 mm	30°	90°	120 mm	Opposite	J-Lock	5.0 mm
4131†	2.7 mm	30°	90°	67 mm	Opposite	J-Lock	5.0 mm
4132†	2.7 mm	70°	90°	70 mm	Opposite	J-Lock	5.0 mm
7208133†	1.9 mm	30°	75°	62 mm	Opposite	J-Lock	2.0 mm

REF	Description
8001701	O ring

\* Item shown

† HD and non-HD compatible

## Direct-View Arthroscopes

### Direct-View Arthroscopes, Autoclavable

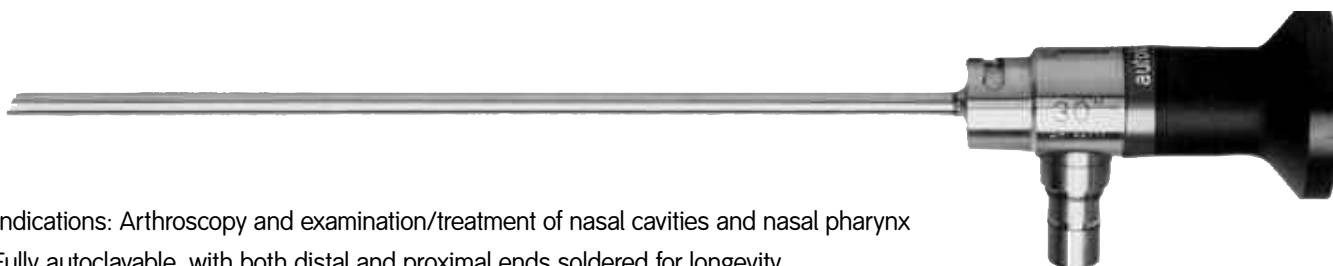

Indications: Arthroscopy and examination/treatment of nasal cavities and nasal pharynx

Fully autoclavable, with both distal and proximal ends soldered for longevity

Wide angle of view

Autoclavable arthroscopes have sapphire distal lenses and rear ocular windows for much greater scratch resistance than conventional glass

Stainless steel construction to withstand sterilization modalities (EtO, Steris®, Sterrad®, and autoclave)

REF	Outer Diameter	Direction of View	Field of View	Working Length	Light Post Direction	Cannula Connection	Recommended Light Cable
72202087	4.0 mm	30°	115°	160 mm	Opposite	J-Lock	5.0 mm
72202088	4.0 mm	70°	115°	160 mm	Opposite	J-Lock	5.0 mm
72202089	4.0 mm	45°	115°	157 mm	Opposite	J-Lock	5.0 mm
72202090	4.0 mm	0°	115°	160 mm	Opposite	J-Lock	5.0 mm
7208132	4.0 mm	30°	115°	175 mm	Opposite	Storz	5.0 mm
72200733	2.7 mm	70°	80°	119 mm	Opposite	J-Lock	5.0 mm
72201747	2.7 mm	30°	80°	67 mm	Same side	J-Lock	5.0 mm
7205682	2.7 mm	30°	90°	67 mm	Opposite	J-Lock	5.0 mm
7205681	2.7 mm	30°	80°	120 mm	Opposite	J-Lock	5.0 mm

Note: Compatible with all camera head with couplers

### Direct-View Arthroscopes, Non-Autoclavable

Indications: Arthroscopy and examination/treatment of nasal cavities and nasal pharynx

Wide angle of view

Stainless steel construction to withstand sterilization modalities (EtO, Steris®, and Sterrad®)

REF	Outer Diameter	Direction of View	Field of View	Working Length	Light Post Direction	Cannula Connection	Recommended Light Cable
4184	1.9 mm	30°	80°	67 mm	Opposite	J-Lock	2.0 mm

REF	Description
7205548	Aluminum oxide vial for cleaning autoclavable endoscope lenses
7210721	Protective cap for autoclavable scopes. Fits 4.0 mm and 5.5 mm scopes. Package of 70.



## Specialty Endoscopes (ECTRA<sup>®</sup> II) and Accessories

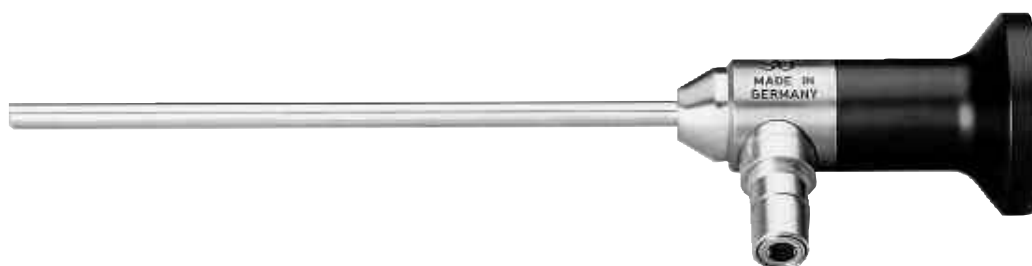

Indications: Endoscopic release of carpal ligament, plantar fascia, and the extra-articular lateral ligament

Wide angle of view

Stainless steel construction to withstand sterilization modalities (EtO, Steris<sup>®</sup>, and Sterrad<sup>®</sup>)

REF	Type	Focal Length	Outer Diameter	Direction of View	Field of View	Working Length	Light Post Direction	Recommended Light Cable
4144*	Direct-View	N/A	4.0 mm	30°	100°	106 mm	Same Side	5.0 mm
3896	Video	35 mm	4.0 mm	30°	100°	106 mm	Same Side	5.0 mm
72201597	Direct-View	N/A	4.0 mm	30°	115°	278 mm	Opposite Side	5.0 mm
72201598	Direct-View	N/A	4.0 mm	70°	115°	280 mm	Opposite Side	5.0 mm

### Replacement Parts

Light post Adaptor Sleeve: Fits all Arthroscopes, Hysteroscopes/Cystourethroscopes, and Laparoscopes with 4 mm light post



REF	Description
7207900	For Storz <sup>®</sup> Light Guide, outside threads, full length
4347*	For Smith & Nephew/Wolf <sup>®</sup> Light Guide
8001701	Replacement O-ring for videoscope and C-mount couplers



\* Item shown

## Made to Order

Made to Order products have longer production times. Please contact your sales representative or customer service for more information.

### VideoArthroscope, Multimode

Compatible with Smith & Nephew Non-Autoclavable Camera Heads (C-Mount)

REF	Outer Diameter	Direction of View	Field of View	Working Length	Light Post Direction	Cannula Connection	Recommended Light Cable
7209911Z	4.0 mm	30°	115°	160 mm	Same Side	J-Lock	5.0 mm
7210750	4.0 mm	30°	115°	97 mm	Same Side	J-Lock	5.0 mm

### VideoArthroscopes, non-autoclavable

Black Focus Ring, 25 mm focal length

Indications: Arthroscopy and examination/treatment of nasal cavities and nasal pharynx

Stainless steel construction to withstand sterilization modalities (EtO, Steris®, and Sterrad®)

Wide angle of view

Ergonomically designed to directly attach to the camera head for ease of use

Insertion needle is fully rotatable without the need to reposition the camera head

Compatible with Smith & Nephew Non-Autoclavable Camera Heads (C-Mount)

Not for use with HD camera heads

REF	Outer Diameter	Direction of View	Field of View	Working Length	Light Post Direction	Cannula Connection	Recommended Light Cable
4486	4.0 mm	30°	115°	160 mm	Same Side	J-Lock	5.0 mm

### VideoArthroscopes, Non-Autoclavable

Blue Focus Ring, 35 mm focal length

Indications: Arthroscopy and examination/treatment of nasal cavities and nasal pharynx

Stainless steel construction to withstand chemical sterilization modalities (EtO, Steris®, and Sterrad®)

Wide angle of view

Ergonomically designed to directly attach to the camera head for ease of use

Insertion needle is fully rotatable without the need to reposition the camera head

Compatible with Smith & Nephew Non-Autoclavable Camera Heads (C-Mount)

Not for use with HD camera heads

REF	Outer Diameter	Direction of View	Field of View	Working Length	Light Post Direction	Cannula Connection	Recommended Light Cable
7210987	1.9 mm	30°	75°	65 mm	Opposite	J-Lock	5.0 mm
3797	2.7 mm	70°	90°	70 mm	Opposite	J-Lock	5.0 mm

## Made to Order

Made to Order products have longer production times. Please contact your sales representative or customer service for more information.

### Direct-View Arthroscopes, Autoclavable

REF	Outer Diameter	Direction of View	Field of View	Working Length	Light Post Direction	Cannula Connection	Recommended Light Cable
7210694	2.7 mm	0°	80°	67 mm	Opposite	J-Lock	5.0 mm
7210910	2.7 mm	0°	80°	120 mm	Opposite	J-Lock	5.0 mm
7204734	4.0 mm	0°	115°	175 mm	Opposite	Storz <sup>®</sup>	5.0 mm
7204735	4.0 mm	70°	115°	175 mm	Opposite	Storz	5.0 mm

### Direct-View Arthroscopes, Non-Autoclavable

REF	Outer Diameter	Direction of View	Field of View	Working Length	Light Post Direction	Cannula Connection	Recommended Light Cable
3948	2.7 mm	70°	90°	70 mm	Opposite	J-Lock	5.0 mm

### Specialty Endoscopes

REF	Type	Focal Length	Outer Diameter	Direction of View	Field of View	Working Length	Light Post Direction	Recommended Light Cable
4139Z	Video	25 mm	4.0 mm	30°	115°	106 mm	Same Side	5.0 mm

### Diagnostic Cannulas, Extended Length

For use with hip arthroscopy scopes REF 7211054 and 7211055

REF	Description
7211075	5.8 mm diagnostic cannula, single valve, rotatable
7207913	5.8 mm diagnostic cannula, double valve, rotatable
7207898	Cannulated obturator for cannulas 7211075 and 7207913

# C

Cannulas, Trocars, and Obturators .....	C-1
Hip Arthroscopy .....	C-7
Cannulas, Obturators, and Irrigation Extenders.....	C-7
Small Joint Cannula Sets.....	C-8
InteliJET® Reusable Cannulas .....	C-10
Disposable Cannulas .....	C-12
CLEAR-TRAC® COMPLETE Disposable Cannula System .....	C-12
CLEAR-TRAC® FLEXIBLE Disposable Cannula System .....	C-13
Made to Order.....	C-16
Replacement O-Rings .....	C-19
ARTHROPAK® .....	C-20
Customized Procedure Kit.....	C-20

## Arthroscopic Cannula Systems

### Product Highlights



#### **CLEAR-TRAC® COMPLETE** Disposable Cannula System

- **NEW** Integrated triple-seal design
- **NEW** Suture management system
- Removable cannula cap
- Tall thread configuration
- Transparent polycarbonate body
- Latex free Design

CLEAR-TRAC COMPLETE  
Page C-12



#### **CLEAR-TRAC® FLEXIBLE** Disposable Cannula System

- **NEW** Integrated triple-seal design
- **NEW** Suture management system
- **NEW** Flexible body material
- **NEW** Thread configuration
- Transparent body
- Capped flow port with optional disposable stopcock
- Latex free Design

CLEAR-TRAC FLEXIBLE  
Page C-13

# Cannulas, Trocars, and Obturators

## Diagnostic Cannula Sets



REF	Description
72200829*	6.0 mm High Flow Diagnostic Cannula, double-valve, rotatable
72200830	6.0 mm High Flow Diagnostic Cannula, single-valve, rotatable
8006653	O-ring for both cannulae
72201439	6.0 mm High Flow Diagnostic Cannula, single-valve, rotatable, for use with Stryker® scopes
72201440	6.0 mm High Flow Diagnostic Cannula, double-valve, rotatable, for use with Stryker® scopes
72201627	6.0 mm High Flow Diagnostic Cannula, single-valve, rotatable, for use with Storz scopes
72201628	6.0 mm High Flow Diagnostic Cannula, double-valve, rotatable, for use with Storz scopes
72201693	5.0 mm Medium Flow Diagnostic Cannula, single-valve, rotatable
72201712*	5.0 mm Medium Flow Diagnostic Cannula, double-valve, rotatable

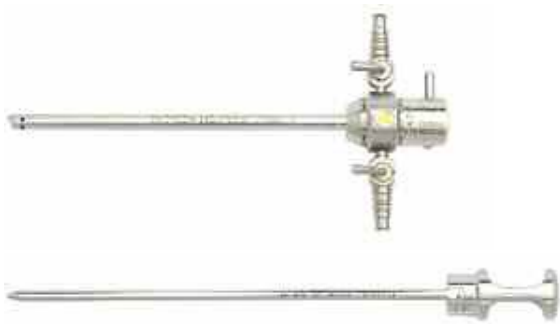

3868	6.0 mm High Flow Diagnostic Cannula Set, double-valve, rotatable
Set Includes:	
72200829	6.0 mm High Flow Diagnostic Cannula, double-valve, rotatable
4356	Obturator, conical tip







7204711	6.0 mm High Flow Diagnostic Cannula Set, single-valve, rotatable
Set Includes:	
72200830	6.0 mm High Flow Diagnostic Cannula, single-valve, rotatable
4356	Obturator, conical tip

\* Item shown

## Cannulas, Trocars, and Obturators

### Operative Cannulas

	REF	Description
	3175*	4.5 mm Operative Cannula, no distal holes, for 4.0 mm arthroscopes with light post on OPPOSITE SIDE of direction of view
	3673	4.5 mm Operative Cannula, distal holes, for 4.0 mm arthroscopes with light post on OPPOSITE SIDE of direction of view
	2704*	4.5 mm Operative Cannula, distal holes, for 4.0 mm arthroscopes with light post on SAME SIDE of direction of view
	3176*	5.5 mm Operative Cannula, no distal holes, for 4.0 mm arthroscopes with light post on OPPOSITE SIDE of direction of view
	7204708	5.5 mm Operative Cannula, distal holes, for 4.0 mm arthroscopes with light post on OPPOSITE SIDE of direction of view
	2711*	5.5 mm Operative Cannula, no distal holes, for 4.0 mm arthroscopes with light post on SAME SIDE of direction of view

### Operative Cannulas with Fluid Seals

For 4 mm DYONICS® Arthroscopes with light post on OPPOSITE SIDE of direction of view, J-Locking interface.

	7205366*	5.5 mm Cannula, outflow valve, distal holes, with fluid seal
	7205368	5.5 mm Cannula, outflow valve, no distal holes, with fluid seal
	7205367	5.5 mm Cannula, finger post, distal holes, with fluid seal
	7205369	5.5 mm Cannula, no distal holes, with fluid seal

### Operative Cannula Accessories

	7204864	Infusion Adaptor with valve for inflow or outflow. Attaches to cannulas REF 3673, 7204708, 2704, 2711, 3175, and 3176
	4536	Fluid seals, package of 25

\* Item shown

## Cannulas, Trocars, and Obturators

### Irrigation Extenders



REF	Description
72200027	Fluid seals
72200831*	High Flow Irrigation Extender, double-valve, rotatable
72200832	High Flow Irrigation Extender, single-valve, rotatable
72201021	High Flow Irrigation Extender for Cannulas with fluid seals, single-valve, rotatable
72201022*	High Flow Irrigation Extender for Cannulas with fluid seals, double-valve, rotatable

### InteliJET® Irrigation Extenders



7205370	Irrigation Extender for cannulas, with fluid seals, with outflow valve.
7205371	Irrigation Extender for cannulas, with fluid seals, rotatable

\*Item shown

Call +1-800-343-5717 (U.S.) or contact your local representative.



## Cannulas, Trocars, and Obturators

### Obturators and Trocar

	REF	Description
	7205376	Obturator, blunt tip, fits all 4.5 mm, 6.0 mm and 6.0 mm diagnostic cannulas
	7204812	Obturator, blunt tip, fits all 6.0 mm diagnostic cannulas with Storz interface
	4356	Obturator, conical tip, fits all 4.5 mm and 5.8 mm diagnostic cannulas
	72200402	Obturator, conical tip, 4.5 mm with 1.5 mm, fits all 4.5 mm and 6.0 mm diagnostic cannulas
	7207701	Obturator, conical tip, fits all 6.0 mm diagnostic cannulas with Stryker® interface
	7204811	Obturator, conical tip, fits all 6.0 mm diagnostic cannulas with Storz interface
	7209965	Obturator, conical tip, fits all 5.0 mm diagnostic cannulas
	1992*	4.5 mm Obturator, conical tip, fits all 4.5 mm operative cannulas
	2209*	5.5 mm Obturator, conical tip, fits all 5.5 mm operative cannulas
	7205783	5.5 mm Obturator, conical tip, for cannulas with fluid seals
	7205377	Trocar, sharp tip, fits all 4.5 mm and 6.0 mm diagnostic cannulas
	7204810	Trocar, sharp tip, fits all 6.0 mm diagnostic cannulas with Storz interface
	1995*	4.5 mm Trocar, sharp tip, fits all 4.5 mm operative cannulas
	7202210	5.5 mm Trocar, sharp tip, fits all 5.5 mm operative cannulas
	3801*	Switching Stick, 4.3 mm x 13"
	3802	Switching Sleeve, 4.5 mm x 10"
	2787	Wissinger Rod, 4.5 mm
	7205395	Nitinol Guide Wire, 1.2 mm x 45 cm, package of 3
<b>Outflow Cannula Set</b>		
	7204910	Outflow Cannula Set
	Set includes:	
	7204863	3 mm Outflow Cannula with distal holes
	7204865	Obturator, conical tip

\* Item shown

## Cannulas, Trocars, and Obturators

### Operative Cannula Sets – 4.5 mm



## REF

## Description

3709

4.5 mm Operative Cannula Set for 4.0 mm arthroscopes with light post on OPPOSITE SIDE of direction of view

## Set Includes:

3673

4.5 mm Operative Cannula (2 per set)

1995

4.5 mm Trocar, sharp tip

1992

4.5 mm Obturator, conical tip

3708

Irrigation Extender, single-valve, fixed

1986

Infusion Adaptor



2701

4.5 mm Operative Cannula Set for 4.0 mm arthroscopes with light post on SAME SIDE of direction of view

## Set Includes:

2704

4.5 mm Operative Cannula (2 per set)

1995

4.5 mm Trocar, sharp tip

1992

4.5 mm Obturator, conical tip

2705

Irrigation Extender, single-valve, fixed

1986

Infusion Adaptor



4188

4.5 mm Rotatable Operative Cannula Set for 4.0 mm arthroscopes with light post on OPPOSITE SIDE of direction of view

## Set Includes:

3673

4.5 mm Operative Cannula (2 per set)

1995

4.5 mm Trocar, sharp tip

1992

4.5 mm Obturator, conical tip

3814

Irrigation Extender, single-valve, rotatable

1986

Infusion Adaptor

## Cannulas, Trocars, and Obturators

### Operative Cannula Sets – 5.5 mm



## REF

## Description

3112

5.5 mm Operative Cannula Set for 4.0 mm arthroscopes with light post on SAME SIDE of direction of view

## Set Includes:

2711

5.5 mm Operative Cannula (2 per set)

7202210

5.5 mm Trocar, sharp tip

2209

5.5 mm Obturator, conical tip

1986

Infusion Adaptor



7204709

5.5 mm Operative Cannula Set for 4.0 mm arthroscopes with light post on OPPOSITE SIDE of direction of view

## Set Includes:

7204708

5.5 mm Operative Cannula (2 per set)

7202210

5.5 mm Trocar, sharp tip

2209

5.5 mm Obturator, conical tip

1986

Infusion Adaptor



1986

Infusion Adaptor

## Hip Arthroscopy Cannulas, Obturators, and Irrigation Extenders

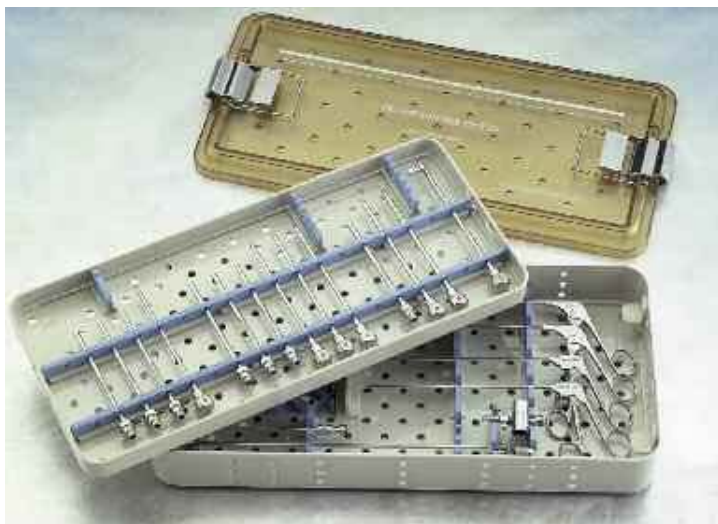

The system consists of color-coded cannulas and obturators, cannulated and solid. By using arthroscopy needles and guide wires, precise portal placement can be achieved.

Hip-specific ACUFEX<sup>®</sup> manual instruments with the patented pinless hinge enable manipulation and resection of soft tissue and removal of loose bodies.

System is designed to allow maximum flexibility in terms of set definition. Surgeons can customize to their preferred surgical technique.

System is compatible with standard-length 4.0 mm arthroscopes.

REF	Description
-----	-------------

### Arthroscopic Hip Set Instrumentation – Cannulas

7209345	3.0 mm Cannula, Inflow
7207748	4.5 mm Cannula, Operative (no holes), green
7207745	5.0 mm Cannula, Operative (no holes), blue
7207742	5.5 mm Cannula, Operative (no holes), red
7210393	5.5 mm Slotted Cannula

### Arthroscopic Hip Set Instrumentation – Obturators

72200884	4.5 mm Obturator, Conical, green, used with REF 7207748
72200885	4.5 mm Obturator, Cannulated, green, used with REF 7207748
72200096	4.5 mm Obturator, Cannulated, green, large Delrin handle, used with REF 7207748
72200882	5.0 mm Obturator, Conical, blue, used with REF 7207745
72200883	5.0 mm Obturator, Cannulated, blue, used with REF 7207745
72200097	5.0 mm Obturator, Cannulated, blue, large Delrin handle, used with REF 7207745
72200880	5.5 mm Obturator, Conical, red, used with REF 7207742
72200881	5.5 mm Obturator, Cannulated, red, used with REF 7207742
72200098	5.5 mm Obturator, Cannulated, red, large Delrin handle, used with REF 7207742
7207751	5.5 mm Obturator, long, Cannulated, used with disposable Cannula REF 7205360 pg. K-4
7210392	5.5 mm Obturator, Cannulated, used with slotted cannula REF 7210393
7209349	Obturator for 3.0 mm cannula

### Arthroscopic Hip Set Instrumentation – Irrigation Extenders

7209346	Irrigation Extender with Valve
7209347	Irrigation Extender with InteliJET <sup>®</sup> Inflow
7209348	Irrigation Extender with InteliJET Inflow and Valve
72200004	Irrigation Extender, rotatable, with InteliJET inflow
7210224	Irrigation Extender, rotatable, with InteliJET Inflow and Valve
72200083	Irrigation Extender, rotatable, double valve
72200084	Irrigation Extender, rotatable, single valve

## Small Joint Cannula Sets

### Small Joint Cannula Sets

REF	Description
4294	2.2 mm Operative Cannula Set for 1.9 mm SHORT SCOPE with light post on OPPOSITE SIDE of direction of view
Set Includes:	
3865	2.2 mm Short Cannula, with flow port
3866	2.2 mm Short Trocar, sharp tip
3867	2.2 mm Short Obturator, conical tip
3312	TMJ/Wrist Probe
3713	2.9 mm Operative Cannula Set for 2.7 mm LONG SCOPE with light post on OPPOSITE SIDE of direction of view
Set Includes:	
3672	2.9 mm Short Cannula with finger post (2 per set)
3785	2.9 mm Short Trocar, sharp tip
3807	2.9 mm Short Obturator, conical tip
3671	Irrigation Extender, single-valve, fixed
3696	Infusion Adaptor
3800	2.9 mm Operative Cannula Set for 2.7 mm SHORT SCOPE with light post on OPPOSITE SIDE of direction of view
Set Includes:	
3781	2.9 mm Short Cannula with flow port (2 per set)
3807	2.9 mm Short Obturator, conical tip
3786	2.9 mm Short Obturator, blunt tip
3312	TMJ/Wrist Probe
4147	Probe handle

## Small Joint Cannula Sets

### Small Joint Cannula Sets





REF	Description
3714	2.9 mm Diagnostic Cannula Set for 2.7 mm LONG SCOPE with light post on OPPOSITE SIDE of direction of view
Set Includes:	
4419	2.9 mm Cannula with flow port
3691	2.9 mm Trocar, sharp tip
3692	2.9 mm Obturator, conical tip



4317	3.6 mm Operative Cannula Set for 2.7 mm SHORT SCOPE with light post on OPPOSITE SIDE of direction of view
Set Includes:	
4308	3.6 mm Operative Cannula, single-valve, fixed
4309	3.6 mm Sharp Trocar
4310	3.6 mm Obturator, conical tip

## InteliJET<sup>®</sup> Reusable Cannulas

### InteliJET Reusable Cannulas

	REF	Description
	4482	4.0 mm Arthroscopy Inflow Cannula Set for DYONICS <sup>®</sup> Arthroscopes with light post on OPPOSITE SIDE of direction of view
	Set Includes: 4355	6.0 mm Rotatable Cannula with finger post
	4356	Obturator, conical tip
	4549	4.0 mm Arthroscopy Inflow Cannula Set with flush valve For DYONICS Arthroscopes with light post on OPPOSITE SIDE of direction of view
	Set Includes: 4537	6.0 mm Rotatable Cannula with flush valve
	4356	Obturator, conical tip
	4481	2.7 mm Arthroscopy Inflow Cannula Set standard length for DYONICS Arthroscopes with light post on OPPOSITE SIDE of direction of view
	Set Includes: 4438	4.6 mm Rotatable Cannula with finger post
	4439	Obturator, conical tip

### Diagnostic Cannulas, Extended Length

For use with hip arthroscopy scopes REF 7211054 and 7211055

REF	Description
7211094	5.8 mm diagnostic cannula, with InteliJET inflow and valve, rotatable
7207898	4.5 mm Cannulated obturator for cannulas 7211075 and 7207913
8011677	FMS port O ring

## InteliJET<sup>®</sup> Reusable Cannulas

### InteliJET Reusable Cannulas



REF	Description
4525	2.7 mm Arthroscope Inflow Cannula Set — Short. For DYONICS <sup>®</sup> Arthroscopes with light post on OPPOSITE SIDE of direction of view
Set Includes:	
4526	3.8 mm Rotatable Cannula with finger post
4527	Obturator, conical tip

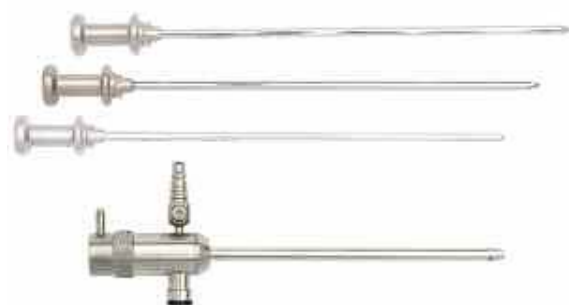

7205176	4.0 mm Storz <sup>®</sup> /Zimmer <sup>®</sup> /Linvatec <sup>®</sup> Arthroscope Inflow Cannula Set for 4 mm arthroscopes with light post on OPPOSITE SIDE of direction of view
Set Includes:	
7205874	6.0 mm Rotatable Cannula with inflow spring lock interface and flush valve
7204810	Trocar
7204811	Obturator, conical tip
7204812	Obturator, blunt tip



7204479	Non-scope Inflow Cannula Set
Set Includes:	
4359	3.0 mm Inflow Cannula
7204478	Obturator, conical tip

### Inflow Cap for InteliJET Cannulas

REF	Description
7209351	Inflow cap for InteliJET cannulas, metal



## Disposable Cannulas

### CLEAR-TRAC<sup>®</sup> COMPLETE Disposable Cannula System



- **NEW** Integrated triple-seal design
- **NEW** Suture management system
- Removable cannula cap
- Tall thread configuration
- Transparent polycarbonate body
- Latex free Design

Introducing the all new, updated CLEAR-TRAC COMPLETE Cannula System, enhanced with a robust triple-seal design and an integrated suture management system. These new features, combined with the many existing facets from the previous generation, provide a truly comprehensive cannula solution.

REF	Description	
<b>CLEAR-TRAC COMPLETE Cannula Family (Sterile, single-use, 10 per box)</b>		
72200902	8.5 mm x 90 mm Threaded Cannula, with disposable obturator, green, box of 10, sterile	BX
72200903	8.5 mm x 72 mm Threaded Cannula, with disposable obturator, green, box of 10, sterile	BX
72200904	8.5 mm x 45 mm Threaded Cannula, with disposable obturator, green, box of 10, sterile	BX
72200905	7.0 mm x 72 mm Threaded Cannula, with disposable obturator, grey, box of 10, sterile	BX
72200906	7.0 mm x 72 mm Smooth Cannula, with disposable obturator, grey, box of 10, sterile	BX
72200907	5.5 mm x 72 mm Threaded Cannula, with disposable obturator, blue, box of 10, sterile	BX
72200908	5.5 mm x 45 mm Threaded Cannula, with disposable obturator, blue, box of 10, sterile	BX
72200909	4.5 mm x 72 mm Threaded Cannula, with disposable obturator, purple, box of 10, sterile	BX
<b>CLEAR-TRAC COMPLETE Reusable Obturators</b>		
72200910	8.5 mm x 90 mm Reusable Obturator (4.3 mm cannulation), green	EA
72200913	8.5 mm x 90 mm Reusable Solid Obturator, green	EA
72200911	8.5 mm x 72 mm Reusable Obturator (4.3 mm cannulation), green	EA
72200912	8.5 mm x 72 mm Reusable Obturator (1.5 mm cannulation), green	EA
72200914	8.5 mm x 72 mm Reusable Solid Obturator, green	EA
72200915	7.0 mm x 72 mm Reusable Obturator (4.3 mm cannulation), grey	EA
72200916	7.0 mm x 72 mm Reusable Obturator (1.5 mm cannulation), grey	EA
72201796	5.5 mm x 72 mm Reusable Obturator (4.3 mm cannulation), blue	EA

## Disposable Cannulas

### CLEAR-TRAC<sup>®</sup> FLEXIBLE Disposable Cannula System



- **NEW** Integrated triple-seal design
- **NEW** Suture management system
- **NEW** Flexible body material
- **NEW** Thread configuration
- Transparent body
- Capped flow port with optional disposable stopcock
- Latex free Design

Introducing the all new, updated CLEAR-TRAC FLEXIBLE Cannula System. Its flexible body material and integrated triple-seal design provide excellent tactile feedback while dramatically reducing fluid leakage.

REF	Description	
<b>CLEAR-TRAC FLEXIBLE Cannula Family (Sterile, single-use, 10 per box)</b>		
72200424	8.0 mm x 90 mm Threaded Cannula, with disposable obturator, lime green, box of 10, sterile	BX
72200425	8.0 mm x 72 mm Threaded Cannula, with disposable obturator, lime green, box of 10, sterile	BX
72200426	8.0 mm x 72 mm Smooth Cannula, with disposable obturator, lime green, box of 10, sterile	BX
72200427	6.5 mm x 72 mm Threaded Cannula, with disposable obturator, orange, box of 10, sterile	BX
72200428	6.5 mm x 72 mm Smooth Cannula, with disposable obturator, orange, box of 10, sterile	BX
72200429	5.5 mm x 72 mm Threaded Cannula, with disposable obturator and trocar, blue, box of 10, sterile	BX
72200430	5.5 mm x 55 mm Threaded Cannula, with disposable obturator and trocar, blue, box of 10, sterile	BX
72200431	5.5 mm x 55 mm Smooth Cannula, with disposable obturator and trocar, blue, box of 10, sterile	BX
72200432	5.5 mm x 45 mm Threaded Cannula, with disposable obturator and trocar, blue, box of 10, sterile	BX
72200433	4.5 mm x 72 mm Threaded Cannula, with disposable obturator, purple, box of 10, sterile	BX
<b>CLEAR-TRAC FLEXIBLE Reusable Obturators</b>		
72200899	8.0 mm x 90 mm Reusable Obturator (4.3 mm cannulation), lime green	EA
72200900	8.0 mm x 72 mm Reusable Obturator (4.3 mm cannulation), lime green	EA
72201846	6.5 mm x 72 mm Reusable Obturator (4.3 mm cannulation), orange	EA
72201796	5.5 mm x 72 mm Reusable Obturator (4.3 mm cannulation), blue	EA
<b>Accessories</b>		
72200658	CLEAR-TRAC Disposable Stopcock	BX

## Disposable Cannulas

### CLEAR-TRAC® Scope/Shaver Cannula

The CLEAR-TRAC Disposable Scope/Shaver Cannula has been specifically designed with users of standard metal operative cannulas in mind. The unique hub design allows irrigation extenders and shaver blades to be connected directly to the cannula, while the integrated double-seal system keeps you dry.



REF	Description
72201634	CLEAR-TRAC Disposable Scope Shaver Cannula, smooth
72201658	CLEAR-TRAC Disposable Scope Shaver Cannula, with rib

### CLEAR-TRAC Screw Cannula

Provides graft protection and aids screw delivery during graft fixation.



REF	Description
7210118*	7.0 mm CLEAR-TRAC Screw Cannula, latex seal
7210119	8.0 mm CLEAR-TRAC Screw Cannula, latex seal
7210120	9.0 mm CLEAR-TRAC Screw Cannula, latex seal
7207227	7.0 mm CLEAR-TRAC Screw Cannula, latex-free seal
7207228	8.0 mm CLEAR-TRAC Screw Cannula, latex-free seal
7207229	9.0 mm CLEAR-TRAC Screw Cannula, latex-free seal

Single-use, sterile, box of 10

### CLEAR-TRAC Threaded Cannula with Obturator

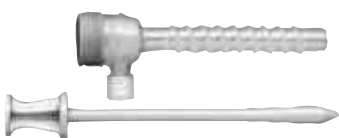

REF	Description
014718*	CLEAR-TRAC Threaded Cannula, 8.0 mm I.D., 76 mm long, green, latex-free seal
014719*	CLEAR-TRAC Threaded Cannula, 5.0 mm I.D., 76 mm long, blue, latex-free seal
7210121	CLEAR-TRAC Threaded Cannula, 8.0 mm I.D., 76 mm long, green, latex seal
7210122	CLEAR-TRAC Threaded Cannula, 5.0 mm I.D., 76 mm long, blue, latex seal

Includes obturator. Single-use sterile packs, box of 10

### CLEAR-TRAC Threaded Cannula with Cannulated Obturator



REF	Description
7207197	CLEAR-TRAC Threaded Cannula, 10 mm I.D., 76 mm long with 4.0 mm cannulated obturator, white, contains latex

Includes cannulated obturator. Single-use sterile packs, box of 10

\* item shown

## Disposable Cannulas

### Disposable Cannula Sets with Distal Holes



REF	Description
4615	4.5 mm Cannula and Obturator, conical tip, distal holes, blue
4616	5.5 mm Cannula and Obturator, conical tip, distal holes, gray
4617	7.0 mm Cannula and Obturator, conical tip, distal holes, forest green
70 mm working length, threaded with seals, latex free, box of 6	

### Disposable Cannula Sets without Distal Holes

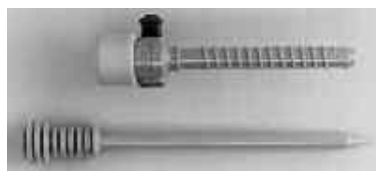

7204895	5.5 mm Cannula and Obturator, conical tip, no holes, orange
7204896	7.0 mm Cannula and Obturator, conical tip, no holes, lime green
70 mm working length, threaded with seals, latex free, box of 6	

### Universal Cannula – Includes Obturator and Trocar

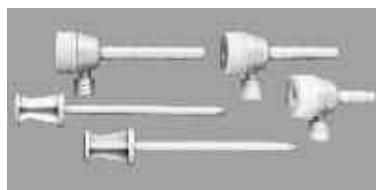

014623	5.0 mm I.D., 55 mm long, blue, latex-free seal
012405	5.0 mm I.D., 76 mm long, blue, latex-free seal
012421	7.0 mm I.D., 76 mm long (includes obturator only), green, latex-free seal
7210126	5.0 mm I.D., 76 mm long, blue, latex seal
Single-use sterile packs, box of 10	

## Made to Order

Made to Order products have longer production times. Please contact your sales representative or customer service for more information.

### 5.5 mm Cannulae, color-coded blue, solid body, no fluid seals

REF	Description
7209953	5.5 mm InteliJET® Cannula with distal holes and finger post same side as direction of view
7209954	5.5 mm InteliJET Cannula with finger post same side as direction of view (no holes)
7209957	5.5 mm InteliJET Cannula with distal holes and finger post opposite direction of view
7209958	5.5 mm InteliJET Cannula with finger post opposite direction of view (no holes)
7210384	5.5 mm Blunt Obturator for 5.5 mm color-coded blue cannulae
72200013	5.5 mm Conical Obturator with threaded interface for 5.5 mm color-coded blue cannula
72200014	5.5 mm Trocar with threaded interface for 5.5 mm color-coded blue cannula
72200012	5.5 mm Blunt Obturator with threaded interface for 5.5 mm color-coded blue cannula

### 5.0 mm Cannulae, color-coded red, solid body, no fluid seals

7209908	5.0 mm InteliJET Cannula with finger post same side as direction of view (no holes)
7209956	5.0 mm InteliJET Cannula with distal holes and finger post opposite direction of view
7209857	5.0 mm InteliJET Cannula with finger post opposite direction of view (no holes)
7209923	5.0 mm Trocar for 5.0 mm color-coded red cannulae
7210385	5.0 mm Blunt Obturator for 5.0 mm color-coded red cannulae
72200010	5.0 mm Conical Obturator with threaded interface for 5.0 mm color-coded red cannula
72200011	5.0 mm Trocar with threaded interface for 5.0 mm color-coded red cannula
72200009	5.0 mm Blunt Obturator with threaded interface for 5.0 mm color-coded red cannula

### 2.7 mm Arthroscope Cannulae (standard length)

7205989	3.8 mm Cannula, FMS, rotatable, with flush-valve
6900392	2.9 mm Cannula, low flow, double-valve, rotatable, (Use with 2.7 mm standard arthroscope)
6900284	2.9 mm Obturator for 2.9 mm Cannula (6900392)
6900154	4.6 mm Cannula, FMS, rotatable, with flush-valve. Used with Obturator (4439)
72200121	4.6 mm Cannula, high-flow, rotatable, single-valve. Used with Obturator (4439)

### 2.7 mm Arthroscope Cannulae (short length)

7205984	3.8 mm Cannula, FMS, rotatable, with flush-valve. Used with Obturator (4527)
6900513	Obturator, blunt tip, for 3.8 mm Cannula (4526)
7210715	3.8 mm Rotatable Cannula with double-valve
7207789	3.8 mm Rotatable Cannula with single-valve

## Made to Order

Made to Order products have longer production times. Please contact your sales representative or customer service for more information.

### Cannulae

REF	Description
6900022Z	2.9 mm Cannula, Short, with single-valve
7205984	3.8 mm InteliJET <sup>®</sup> Cannula, Short, with valve opposite inflow (used with 2.7 mm arthroscope)
4491	4.5 mm Diagnostic Cannula, single-valve, rotatable
7205372	4.5 mm Diagnostic Cannula, double-valve, fixed body
3134300	4.5 mm, no holes, finger post opposite direction of view
6900391Z	4.5 mm Cannula with 6 distal holes
6900215Z	4.5 mm Cannula, Operative, with finger post same side as direction of view
6900237Z	5.0 mm InteliJET Cannula with distal holes and finger post opposite direction of view
6900084Z	5.5 mm InteliJET Cannula with distal holes and finger post same side as direction of view
6900167Z	5.5 mm InteliJET Cannula with distal holes and finger post opposite direction of view
6900092Z	5.5 mm InteliJET Cannula with finger post opposite direction of view (no holes)
6900106Z	5.5 mm InteliJET Cannula with finger post same side as direction of view (no holes)
72201374	6.0 mm High Flow Cannula, Diagnostic, Rotatable, single-valve, with Storz spring loaded interface
72201375	6.0 mm High Flow Cannula, Diagnostic, Rotatable, double-valve, with Storz spring loaded interface

### Trocar

6900279Z	5.5 mm Trocar for use with 5.5 mm InteliJET Cannulae
----------	--

### Irrigation Extenders

7209959	Irrigation Extender for color-coded cannula sets, single valve, rotatable
---------	---

Additional Irrigation Extenders for color-coded cannulas can be found on page C-7

4493	Irrigation Extender, double-valved, rotatable
3814	Irrigation Extender, single-valve, rotatable
3708	Irrigation Extender, single-valve, fixed for 4.0 mm arthroscopes with light post on same side of direction of view
2705	Irrigation Extender, single-valve, fixed for 4.0 mm arthroscopes with light post on opposite side of direction of view

### Miscellaneous

6900295Z	Switching Stick, 3.0 mm, used with REF 7209345 pg. K-3 and REF 4359
6900274	3.0 mm Inflow Cannula with six distal holes. Used with Obturator (7204478)
7209351	Inflow Cap
6900513	Obturator, blunt tip
7210284	3.0 mm Inflow Cannula, 90°, no obturator.

\* Item shown

## Made to Order

Made to Order products have longer production times. Please contact your sales representative or customer service for more information.

### Diagnostic Cannulas, Extended Length

For use with hip arthroscopy scopes REF 7211054 and 7211055

REF	Description
7211094	5.8 mm Diagnostic cannula, with InteliJET® inflow and valve, rotatable
7207913	5.8 mm Diagnostic cannula, double-valve, rotatable
7207898	4.5 mm Cannulated obturator for cannulas 7211075 and 7207913

### Arthroscopic Hip Set Instrumentation – Irrigation Extenders

72200083	Irrigation Extender, rotatable, double-valve
72200084	Irrigation Extender, rotatable, single-valve
72200004	Irrigation Extender, rotatable, with InteliJET inflow

## Replacement O-Rings

Cannulas	O-Ring: Scope Side	O-Ring: Cannula Side	O-Ring: FMS Port
3671	8006517		
3672	8006517		
3781	8006517		
3865	8010199 (2 each)		
3869	8006653		
4308	8003734		
4355	8006653		8011677
4359			8011677
4419	8006517		
4438	8010199		8011677
4491	8006653		
4492	8006653		
4526	8010199		8011677
4537	8006653		8011677
7205372	8006653		
7205874			8011677
72200829	8006653		
72200830	8006653		

Irrigation Extenders	O-Ring: Scope Side	O-Ring: Cannula Side	O-Ring: FMS Port
2705	8006653	8006652 (2 each)	
3708	8006653	8006652 (2 each)	
3814	8006653	8006652 (2 each)	
4493	8006653	8006652 (2 each)	
7205370	8006653	8006652 (2 each)	
7205371	8006653	8006652 (2 each)	8011677
4355	8006653	8006652 (2 each)	8011677



## ARTHROPAK<sup>®</sup>

### Customized Procedure Kit



#### ARTHROPAK Customized Procedure Kit

Smith & Nephew DYONICS<sup>®</sup> ARTHROPAK Customized Procedure Kits provide increased operational efficiencies and reduced supply expense. You customize your kit with your selection of disposable Smith & Nephew products for any arthroscopic procedure at a reduced cost!

- Free customized service
- Reduced product cost
- Save valuable time and demand on staff
- Streamlined ordering process
- Increased standardization
- Reduced inventory

DYONICS ARTHROPAK Customized Procedure Kits reduce the number of SKUs that need to be ordered and aggregate purchasing volume of arthroscopic products by enabling purchase from a single supplier. Please ask your local sales representative to demonstrate how DYONICS ARTHROPAK Customized Procedure Kits can benefit your practice.

# D

Smith & Nephew DYONICS® POWER  
Control Systems .....D-1  
Smith & Nephew DYONICS® Motor  
Drive Units .....D-2  
Accessories .....D-3  
Replacement Parts .....D-4

## Shaver Systems

### Product Highlights



**NEW! Smith & Nephew DYONICS POWERMINI Small Joint Handpiece** with Blade Multi-Positioning, hand controls, suction lever.

DYONICS POWERMINI  
Small Joint Handpiece  
Page D-2



**DYONICS POWER II Control Unit**  
Combines the most aggressive arthroscopic soft tissue resection with powerful torque for efficient bone removal. Compatible with all DYONICS POWER handpieces and footswitches.

DYONICS POWER II Control Unit  
Page D-2



**DYONICS POWER II Footswitch**  
Ergonomic design may be operated in variable speed or on/off modes. Provides flexibility to operate in variable speed or on/off modes and activate handpiece and footswitch controls during a procedure.

DYONICS POWER II Footswitch  
Page D-3

## Smith & Nephew DYONICS<sup>®</sup> POWER Control Systems



### Smith & Nephew DYONICS POWER Shaver Systems

The following features are standard on all DYONICS POWER control units:

- Blade family auto-recognition recalls blade and burr settings
- Blade window lock helps protect tissue from open edgeforms
- Communicates with DYONICS 25 and InteliJET<sup>®</sup> pumps to maximize visibility while minimizing fluid usage.

In addition, the high-performance DYONICS POWER II Control Unit offers two unique, customizable oscillate modes for efficient soft tissue resection; dual hot ports for simultaneous shaver and powered instrument operation; and an integrated flush lavage feature to rapidly clear the visual field of debris.

REF	Description
72200873	Smith & Nephew DYONICS POWER II Shaver System Control Unit. All units 100-240 VAC, 50/60 Hz
72201030	U.S. system
72201034	U.K. system
72201037	German system
72201040	Spanish system
72201043	French system
72201046	Italian system
72201049	Swedish system
72201052	Dutch system
72201055	Portuguese system
72201058	Danish system
72201061	Norwegian system
72201322	Korean system

All kits include a control unit, power cord, and operations manual.

REF	Description
7205841	Smith & Nephew DYONICS POWER Shaver System Control Unit. All units 100-240 VAC, 50/60 Hz
7205886	U.S. kit
7205887	U.K. kit
7205888	International kit
7205889	French kit
7205890	German kit
7205891	Dutch kit
7205892	Italian kit
7205893	Spanish kit
7205894	Swedish kit

All kits include a power cord, operations manual and communications cable for the DYONICS 25 Pump

Call +1-800-343-5717 (U.S.) or contact your local representative.

## Smith & Nephew DYONICS<sup>®</sup> Motor Drive Units

For use with Smith & Nephew DYONICS POWER and EP-1<sup>®</sup> Control Units

REF	Description
-----	-------------



72200616*	Smith & Nephew DYONICS POWERMAX <sup>®</sup> ELITE Handpiece with blade multi-positioning, hand controls, suction lever, 10 ft (3 m) cord
-----------	---



72200617*	Smith & Nephew DYONICS POWERMAX ELITE Handpiece with Blade Multi-Positioning, no hand controls, suction lever, 10 ft (3 m) cord
-----------	---



72200872	Smith & Nephew DYONICS POWERMAX ELITE Handpiece hand-controlled with opposite-side suction lever
----------	--

\*NOTE: MDU's accept all blades



72201500	POWERMINI Small Joint Handpiece with blade multi-positioning, hand controls, suction lever, 10 ft. (3m) cord For use with Smith & Nephew DYONICS POWER II Control System.
----------	---



72201503	POWERMINI Small Joint Handpiece with Blade Multi-Positioning, no hand controls, suction lever, 10 ft. (3m) cord For use with Smith & Nephew DYONICS POWER II Control System.
----------	--

\*\*NOTE: MDU only works with the "Disposable Small Joint Blades/Burrs" listed on page E-7.



7205357	Smith & Nephew DYONICS Mini-Motor Drive, suction lever, 10 ft (3 m) cord
---------	--



7205971***	Smith & Nephew DYONICS POWER Ultralight Motor Drive, suction lever, 10 ft (3 m) cord
------------	--

\*\*\*NOTE: MDU accepts all straight blades, but only ULTRA series curved blades.

## Accessories

### Smith & Nephew DYONICS® POWER Footswitches



Low profile, cutting mode and blade window lock control, 12 ft (3.6 m) cord

REF	Description
7205399*	Smith & Nephew DYONICS POWER Footswitch, low profile, on/off
7205397	Smith & Nephew DYONICS POWER Footswitch, low profile, variable speed



Pedal-style, 12 ft (3.6 m) cord

REF	Description
7205396	Smith & Nephew DYONICS POWER Footswitch, pedal-style, on/off



DYONICS POWER II Footswitch

REF	Description
72201092	Pedal-style, on/off or variable speed. Operates with DYONICS POWER II Control. (REF. 72200873 only)

### Sterilization Tray

REF	Description
4323	Shaver Sterilization Tray for Smith & Nephew DYONICS POWER shaver handpieces
4324	Shaver Sterilization Insert for Smith & Nephew DYONICS POWER shaver handpieces

\* Item shown

## Replacement Parts

### Replacement Motor Drive Cord



REF	Description
7208207	Replacement Motor Drive Cord for Smith & Nephew DYONICS® POWER and EP-1® handpieces, standard or hand control type

\*NOTE: For standard and POWERMAX MDU's use 8101720 O Ring.

### Replacement power cords and connectors

REF	Description
7205081	AC Power Cord for Smith & Nephew DYONICS POWER and EP-1 Shaver Control Units, 3 ft (90 cm), 120 VAC
4428	AC Power Cord for Smith & Nephew DYONICS POWER and EP-1 Shaver Control Units, 12 ft (3.6 m), 120 VAC
4476	AC Power Cord for Smith & Nephew DYONICS POWER and EP-1 Shaver Control Units, 3.25 ft (1 m), 230 VAC
7205393	Handpiece Connector, Smith & Nephew DYONICS POWER and EP-1 Control Unit, replacement
7205394	Footswitch Connector, Smith & Nephew DYONICS POWER and EP-1 Control Unit, replacement

### Replacement Caps and Lanyards

The table below will assist you in ordering the replacement cap and lanyards. There are three (3) shaver handpiece motor drive cords, therefore, it is important that you reference the serial number on the motor drive cord to the table below to ensure that the proper replacement cap and lanyard is ordered.

System	Description	Replacement REF	Cable Serial Numbers	IFU
S&N DYONICS® POWER and EP-1®	MDU motor cord (SCREW-ON TYPE)	7205902 8100001	TJ 5524 and HIGHER	1060809
S&N DYONICS POWER and EP-1	MDU motor cord (SCREW-ON TYPE)	7205903 8101765	TJ 2860 to TJ 5523	
S&N DYONICS POWER and EP-1	MDU motor cord (PUSH-ON CAP)	8101544*	TJ 0000 to TJ 2859	
S&N DYONICS POWER and EP-1	FOOTSWITCH cord	8100002	ALL	
PS3500EP®	MDU motor cord	8101724	ALL	
Ultralight	MDU motor cord (SCREW-ON TYPE)	7205902 8100001	TJ 5524 and HIGHER	1060809

### Replacement Motor Drive Cords

7208208	Replacement Motor Drive Cord for Smith & Nephew DYONICS POWER and EP-1 Mini Motor Drive
7209071	Replacement Motor Drive Cord for Smith & Nephew DYONICS POWER Ultralight Motor Drive

\*NOTE: Soak cap 8101544 does not include lanyard.

# E

Smith & Nephew DYONICS®  
ELECTROBLADE® Resector .....E-1

Smith & Nephew DYONICS®  
BONECUTTER® Blades .....E-2

Smith & Nephew DYONICS®  
ORBIT® Curved Blades .....E-3

Pre-Curved and Long Disposable Blades...E-4

Straight Disposable Blades .....E-5

Disposable Burrs .....E-7

Disposable Small Joint Blades/Burrs .....E-8

Disposable Mini Blades/Burrs .....E-9

Disposable Mini Blades —  
Long and Curved .....E-10

Short Sheath Components .....E-11

Smith & Nephew offers a complete line of high quality, single-use blades and burrs for all arthroscopic procedures. Smith & Nephew has a wide range of blade styles and components, including curved blades, ORBIT blades, long blades, burrs, small joint blades, and short sheath and obturator handles.

Use of reprocessed, single-use blades may permanently damage, impede performance, or cause failure of your Arthroscopic Shaver System. Use of such products may render any warranties null and void.

## Sterile Disposable Blades and Burrs

### Product Highlights



#### INCISOR® PLUS ELITE blades

Thanks to a precise sharpening process, INCISOR PLUS ELITE blades deliver twice the cutting efficiency of competitive aggressive blades.

INCISOR® PLUS ELITE blades  
Page E-4



#### DYONICS BONECUTTER® ELECTROBLADE® Resection

The first all-in-one device for subacromial decompression, simultaneously resects and coagulates soft tissue and cuts bone.

DYONICS BONECUTTER®  
ELECTROBLADE® Resection  
Page E-2

#### DYONICS ELITE Burrs

Combine power, speed and responsiveness with precision sharpness for aggressive bone resection.



DYONICS ELITE Burrs  
Page E-9



## Smith & Nephew DYONICS<sup>◇</sup> ELECTROBLADE<sup>◇</sup> Resector



DYONICS ELECTROBLADE Resectors deliver simultaneous mechanical resection and coagulation of soft tissue. This helps increase procedure efficiency and maintain visual clarity throughout the procedure. In addition, the bipolar design eliminates the need for a ground pad. The new BONECUTTER ELECTROBLADE Resector is the first all-in-one device for subacromial decompression. It resects and simultaneously coagulates tissue and also cuts bone.

### DYONICS ELECTROBLADE Resectors

Packaged 3 per box, sterile

REF	Description	Latch Color
7205962	DYONICS BONECUTTER <sup>◇</sup> ELECTROBLADE Resector <i>Compatible with the VULCAN<sup>◇</sup> Generator (requires the VULCAN Generator Adapter) and 'the Erbe Generator'</i>	Orange
7209855	VULCAN Generator Adapter <i>Required to operate 7205962, packaged non-sterile, reusable</i>	

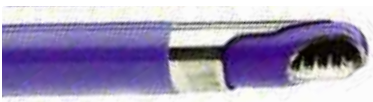
	REF	Description	Latch Color
	7205961	4.5 Full Radius, Valleylab Generator-compatible <i>Compatible with the Valleylab*, Erbe** and VULCAN (when used with the VULCAN Generator Adapter) Generators</i>	Yellow
	7209855	4.5 Full Radius, VULCAN <sup>◇</sup> Generator-compatible	Yellow
	7209700	4.5 ELITE <sup>◇</sup> , Full Radius, Valleylab Generator-compatible <i>Compatible with the Valleylab*, Erbe** and VULCAN (when used with the VULCAN Generator Adapter) Generators</i>	Maroon
	7209983	4.5 ELITE, VULCAN Generator-compatible <sup>+++</sup>	Maroon

\*Valleylab Generator models are the Valleylab Force FX(tm) and Force(tm) 2;

\*\*Erbe Generators are the Erbe 300 and 350



## Smith & Nephew DYONICS<sup>®</sup> BONECUTTER<sup>®</sup> Blades



### Smith & Nephew DYONICS BONECUTTER Blades

Packaged 6 per box, sterile

Resects both soft tissue and bone with a single blade, eliminating the need to switch from a straight blade to a burr

Proprietary SULILLIUM<sup>®</sup> Coating helps maintain blade sharpness and durability throughout the procedure

Ideal for Notchplasty and Acromioplasty procedures

Operates at up to 8000 rpm for effective bone burring



REF	Description	Latch Color
7210486	3.5 Full Radius BONECUTTER Blade	Beige
7206011	4.5 Full Radius BONECUTTER Blade	Yellow
7206010	5.5 Full Radius BONECUTTER Blade	Orange
7206013	4.5 SYNOVATOR <sup>®</sup> with a Full Radius inner BONECUTTER Blade	Forest green
7206012	5.5 SYNOVATOR with a Full Radius inner BONECUTTER Blade	Melon yellow

### Smith & Nephew DYONICS BONECUTTER Long Shaver Blades

18 cm working length, packaged 3 per box, sterile

REF	Description	Latch Color
7210979	4.5 Full Radius BONECUTTER Blade	Clear

## Smith & Nephew DYONICS<sup>®</sup> ORBIT<sup>®</sup> Curved Blades



### DYONICS ORBIT Curved Blades

Packaged 6 per box, sterile

Unique cutting window can be rotated up to 360° while in the joint

Allows for convex and concave blade orientation

Eliminates the need for removing and bending blades

Curve length 17 mm

	Power/EP-1 <sup>®</sup> REF	Ultra Series REF <sup>†</sup>	Description	Latch Color
	7205320	7209029	4.5 mm ORBIT INCISOR <sup>®</sup>	Lime green
	7205321	7209030	4.5 mm ORBIT SYNOVATOR <sup>®</sup>	Forest green
	7205322	7209031	4.5 mm ORBIT RAZORCUT <sup>®</sup>	Pink
	7205323	7209028	4.5 mm ORBIT Full Radius	Yellow
	7210719	N/A	4.5 mm ORBIT Full Radius ELITE <sup>®</sup>	Maroon
	7205687	7209032	4.5 mm ORBIT INCISOR Plus	Violet

REF	Description
7205980	Cleaning brushes for curved blades, packaged 6 per box, not sterile

<sup>†</sup> Ultra Series blades are compatible with the DYONICS Power UltraLight Motor Drive only (REF 7205971 pg. D-2)

## Pre-Curved and Long Disposable Blades

### Pre-Curved Disposable Blades

All curve lengths 17 mm, packaged 6 per box, sterile

	Power/EP-1 REF	Ultra Series REF†	Description	Latch Color
	7211033	N/A	4.5 mm concave, curved, TURBO WHISKER® Blade	Navy blue
	7205332	7209026	4.5 mm concave, curved, INCISOR®	Lime green
	7205334	7209027	4.5 mm concave, SYNOVATOR®	Forest green
	7210980	N/A	3.5 mm concave, Full Radius	Beige
	7205349	7209025	4.5 mm concave, Full Radius, curve	Yellow
	7210521	N/A	4.5 mm concave, Full Radius with Incisor Inner, curve	Lilac
	7210988	N/A	4.5 mm concave, Full Radius ELITE®	Maroon
	72200036	N/A	4.5 mm INCISOR Plus ELITE	Slate
	7209075	N/A	4.5 mm concave, curved INCISOR® Plus	Violet

### Smith & Nephew DYONICS® POWER/EP-1® Long Shaver Blades and Burrs

18 cm working length, packaged 3 per box, sterile





Power/EP-1 REF	Description	Latch Color
7205335	4.5 mm curved, concave, Full Radius	Yellow
7205336	4.5 mm curved, convex, Full Radius	Yellow
7205341	4.5 mm straight, Full Radius	Yellow
7205343	4.5 mm straight, INCISOR®	Lime green
72200494	4.5 mm Curved INCISOR Plus ELITE	Slate
72200414	4.5 mm INCISOR Plus ELITE	Slate
6900678	5.5 mm Full Radius	Clear
72200080	4.0 mm Long ABRADER	Purple
72200082	5.5 mm Long ABRADER	Black

† Ultra Series blades are compatible with the DYONICS Power UltraLight Motor Drive only (REF 7205971 pg. D-2)

## Straight Disposable Blades

### Straight Disposable Blades

Packaged 6 per box, sterile

	Power/EP-1 REF	Description	Latch Color
	7205316	4.5 mm TURBOWHISKER®	Navy blue
	7209303	4.5 mm Ultra Series TURBOWHISKER <sup>†</sup>	Navy blue
	7205312	3.5 mm INCISOR°	Medium grey
	7209489	4.0 mm INCISOR	Violet
	7205313	4.5 mm INCISOR	Lime green
	7205314	5.5 mm INCISOR	Mocha
	7205310	4.5 mm SYNOVATOR°	Forest green
	7205311	5.5 mm SYNOVATOR	Melon yellow
	7209077	4.5 mm SYNOVATOR outer with Full Radius Inner	Clear
	7205317	3.5 mm RAZORCUT°	Purple
	7205318	4.5 mm RAZORCUT	Pink
	7205319	5.5 mm RAZORCUT	Light pink
	7205308	3.5 mm Cutter	Red
	7205309	4.5 mm Cutter	Blue
	7205685	4.5 mm TURBOCUTTER° II	Sage Green

<sup>†</sup> Ultra Series blades are compatible with the DYONICS Power UltraLight Motor Drive only (REF 7205971 pg. D-2)

## Straight Disposable Blades

### Straight Disposable Blades

Packaged 6 per box, sterile

	Power/EP-1 REF	Description	Latch Color
	7205305	3.5 mm Full Radius	Beige
	7205306	4.5 mm Full Radius	Yellow
	7205307	5.5 mm Full Radius	Orange
	7209201	4.5 mm Full Radius Plus	Burnt orange
	7210751	3.5 mm Full Radius ELITE <sup>®</sup>	Beige
	7210499	4.5 mm Full Radius ELITE	Maroon
	7210909	5.5 mm Full Radius ELITE	Olive
	7205315	4.5 mm TURBOTRIMMER <sup>®</sup>	Powder blue
	7209202	4.5 mm TRIMMER	Brown
	7205345	4.5 mm INCISOR <sup>®</sup> PLUS	Violet
	7205459	5.5 mm INCISOR PLUS	Teal
	72200095	3.5 mm INCISOR PLUS ELITE	White
	7210976	4.5 mm INCISOR PLUS ELITE	Slate
	72200081	5.5 mm INCISOR PLUS ELITE	Lilac
	7209211	3.2 Chondroplasty Blade	

## Disposable Burrs

### Straight Disposable Burrs Packaged 6 per box, sterile

	Power/EP-1 REF (Wide Mouth)	Description	Latch Color	Maximum RPM
	7205324	4.0 mm Abrader	Aqua	8,000
	7205325*	5.5 mm Abrader	Black	8,000
	72200722	4.0 mm ELITE® Abrader	Aqua	10,000
	72200723	5.5 mm ELITE Abrader	Black	10,000
	7209706	4.0 mm Abrader, Left-handed	Clear	8,000
	7205326	4.0 mm Acromionizer	Mauve	8,000
	7205327*	5.5 mm Acromionizer	Brown	8,000
	7209512	4.0 mm Acromionizer with large suction window	Mauve	8,000
	72200724	4.0 mm ELITE Acromionizer	Mauve	10,000
	72200725	5.5 mm ELITE Acromionizer	Brown	10,000
	7205330	4.0 mm STONECUTTER®	Maroon	8,000
	7205331*	5.5 mm STONECUTTER	Olive	8,000
	72200728	4.0 mm ELITE STONECUTTER	Maroon	10,000
	72200729	5.5 mm ELITE STONECUTTER	Olive	10,000
	7209069	5.5 mm STONECUTTER, Left-handed	Clear	8,000
	7205328	4.0 mm NOTCHBLASTER®	Lilac	8,000
	7205329*	5.5 mm NOTCHBLASTER	Peach	8,000
	72200726	4.0 mm ELITE NOTCHBLASTER	Lilac	10,000
	72200727	5.5 mm ELITE NOTCHBLASTER	Peach	10,000
	7205668	4.0 mm ACROMIOBLASTER®	Sage green	8,000
	7205669*	5.5 mm ACROMIOBLASTER	Brick red	8,000
	72200730	4.0 mm ELITE ACROMIOBLASTER	Sage green	10,000
	72200731	5.5 mm ELITE ACROMIOBLASTER	Brick red	10,000
	7209287	5.5 mm ACROMIOBLASTER, Left-handed	Clear	8,000
	7209335	4.5 mm Shielded Burr	White	8,000
	6900988	4.0 mm Tapered Burr	Clear	8,000
	6900996	5.5 mm Tapered Burr	Clear	8,000
	7205727	4.5 mm HELICUT®	Slate	5,000
	7210460	4.5 mm HELICUT, Left-handed	Clear	5,000

\* Item shown





Call +1-800-343-5717 (U.S.) or contact your local representative.

## Disposable Small Joint Blades/Burrs

Driven by the DYONICS II® Power Console, Smith & Nephew's latest platform for small joint arthroscopy includes updated hand controls, enhanced suction lever and port, completely redesigned blade hub attachment, and advanced performance.



REF	Blade Style
72201500*	DYONICS® POWERMINI® Small Joint Handpiece with blade multi-positioning, hand controls, suction lever, 10 ft. (3m) cord
72201503*	DYONICS® POWERMINI® Small Joint Handpiece with blade multi-positioning, no hand controls, suction lever, 10 ft. (3m) cord

	REF	Blade Style	Latch Color
	72201504	2.0 mm TURBOWHISKER®, 7 cm length	Yellow
	72201505	2.9 mm TURBOWHISKER, 7 cm length	Green
	72201506	2.9 mm Cutter, 7 cm length	Beige
	72201507	2.0 mm Full Radius, 7 cm length	Blue
	72201508	2.5 mm Full Radius, 7 cm length	Powder Blue
	72201509	2.9 mm Full Radius, 7 cm length	Red
	72201510	3.5 mm Full Radius, 7 cm length	Plum
	72201512	3.5 mm RAZORCUT®, 7 cm length	Pumpkin Orange
	72201514	3.5 mm INCISOR PLUS ELITE, 7 cm length	Sage Green
	72201518	2.9 mm Abrader, 7 cm length	Orange
	72201519	3.5 mm Abrader, 7 cm length	Aqua

\*item shown







## Disposable Mini Blades/Burrs



### Disposable Mini Blades/Burrs

Used with the Smith & Nephew DYONICS POWER®/EP-1® Mini Motor Drive (REF 7205357 pg. D-2).

Indications: Small joint arthroscopy. Packaged 6 per box, sterile

	Power/EP-1 REF	Description	Hub Color
	3606	2.9 mm Cutter, 7 cm length	Beige
	3407*	2.0 mm TURBOWHISKER®, 7 cm length	Yellow
	3418	2.9 mm TURBOWHISKER, 7 cm length	Green
	3410*	2.0 mm Full Radius, 7 cm length	Blue
	3419	2.9 mm Full Radius, 7 cm length	Red
	6900927	3.5 mm Full Radius, BONECUTTER®, 7 cm length	Black
	3553*	2.9 mm Barrel Abrader, 7 cm length	Purple
	3530*	2.9 mm Abrader, 7 cm length	Orange
	3819	3.5 mm Abrader, 7 cm length	Aqua
	4224*	3.5 mm RAZORCUT®, 7 cm length	Pink
	4225*	3.5 mm INCISOR®, 7 cm length	Turquoise
	7209065	2.9 mm INCISOR, 7 cm length	Lime green
	7209085	2.0 mm INCISOR, 7 cm length	Navy blue

\*item shown



## Disposable Mini Blades — Long and Curved



Used with Smith & Nephew DYONICS® POWER/EP-1® Mini Motor Drives (REF 7205357 pg. D-2)





Curved blade allows greater access to anatomy

Blade Window Lock feature sets blade to lock at any position in window, as selected by the surgeon, protecting tissue from blade edges and controlling suction when not in cutting mode

Long and curved disposable mini blades are identical to the current mini blades, with one clear difference: they are one centimeter longer (8 cm)

### Disposable Mini Blades — Long and Curved

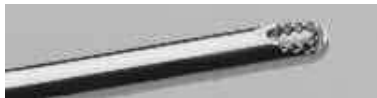
Indications: Small joint arthroscopy. Packaged 6 per box, sterile

	Power/EP-1 REF	Description	Hub Color
	7205474	3.5 mm Full Radius, 8 cm length	Plum
	7210488	3.5 mm Full Radius curved, 8 cm length concave	Brick red
	7205477	3.5 mm RAZORCUT®, 8 cm length	Pumpkin/orange
	7205558	3.5 mm curved, concave, INCISOR®, 8 cm length	Brick red
	7205476	3.5 mm INCISOR Plus, 8 cm length	Sage green

### Mini Irrigating Blades

Indications: Functional Endoscopic Sinus Surgery. Packaged 6 per box, sterile

Power/EP-1 REF	Description	Hub Color
7205688	3.5 mm Full Radius, irrigating, 9 cm length	Plum
7205692	3.5 mm Curved concave INCISOR, irrigating, 9 cm length	Brick red
7205693	3.5 mm INCISOR Plus, irrigating, 9 cm length	Sage green
7205694	FESS Blade Suction tubing	

## Short Sheath Components

### Short Sheath and Obturator

Packaged 6 per box, sterile

Power/EP-1 REF	Description	Latch Color
7205468	4.0 mm Short Sheath and Obturator handle	Maroon
7205470	5.5 mm Short Sheath and Obturator handle	Olive

### Short Sheath and Obturator Components

Reusable Obturator and Replacement O-rings: DYONICS® POWER/EP-1®.

Packaged 12 per box



Power/EP-1 REF	Description
7205458	Reusable O-rings, 4.0 mm
7205457	Reusable O-rings, 5.5 mm

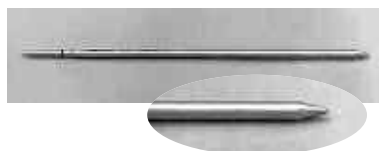

7205456	Reusable obturator, 4.0 mm
7205455	Reusable obturator, 5.5 mm

# F

DYONICS® 25 Fluid Management System, Control Unit, Tube Sets, and Accessories ..	F-1
DYONICS 25 Carts .....	F-3
InteliJET® Tube Sets.....	F-4
Smith & Nephew Access 15 Irrigation System .....	F-5
ARTHROPAK® .....	F-6
Customized Procedure Kit.....	F-6

## Fluid Management

### Product Highlights



**DYONICS 25 Fluid Management System**  
Easy to use, high-flow pump with consistent performance in all arthroscopic applications. Includes a DYONICS 25 Control Unit, fluid level sensors, remote control, and more.

DYONICS 25 Fluid Management System  
Page F-1



**DYONICS 25 Tube Sets**  
A variety of tubing options are available, including cost-effective day tubing

DYONICS 25 Tube Sets  
Page F-2

## DYONICS<sup>®</sup> 25 Fluid Management System, Control Unit, Tube Sets, and Accessories

### DYONICS 25 Fluid Management System

The Smith & Nephew DYONICS 25 Fluid Management System is an easy to use, high-flow pump with consistent performance in all arthroscopic applications.

#### Easy to set up and use

- No calibration required
- Simply insert the tubing cassette and select the cannula size

#### High flow and consistent performance

- Flow rates up to 2.5 lpm
- Maintains stable pressure in the joint and also maintains clear field of view

#### Multiple tube set options

- A variety of tubing options are available, including day tubing, which enables you to select the most cost-effective solution for your facility

#### Compatible with the CONDOR<sup>®</sup> Control System

- Integration with the CONDOR Control System allows operation of this and other medical devices from the sterile field, via wireless technology



### DYONICS 25 Control Unit Set

REF	Display Language	Description
72200207	English (U.S.)	DYONICS 25 Control Unit Set
72200210	English (U.K.)	DYONICS 25 Control Unit Set
72200213	German	DYONICS 25 Control Unit Set
72200216	Spanish	DYONICS 25 Control Unit Set
72200219	French	DYONICS 25 Control Unit Set
72200222	Italian	DYONICS 25 Control Unit Set
72200225	Swedish	DYONICS 25 Control Unit Set
72200228	Dutch	DYONICS 25 Control Unit Set
72200231	Portuguese	DYONICS 25 Control Unit Set
72200234	Danish	DYONICS 25 Control Unit Set
72200237	Norwegian	DYONICS 25 Control Unit Set
72200552	Korean	DYONICS 25 Control Unit Set

Each Smith & Nephew DYONICS 25 Control Unit Set (country specific) includes a DYONICS 25 Control Unit, country-specific power cord, shaver interface cable, biomed test key, user manual, and quick start guide.

## DYONICS<sup>®</sup> 25 Fluid Management System, Control Unit, Tube Sets, and Accessories

### DYONICS 25 Fluid Management System Tube Sets

It is recommended that DYONICS High-flow Cannulas are used with the DYONICS 25 Fluid Management System to ensure optimum performance. Reference Section C.



REF	Description
7211004	DYONICS 25 Inflow Tube Set, 3 per box
7211005	DYONICS 25 Inflow/Outflow Tube Set, single suction, 3 per box
7211006	DYONICS 25 Inflow/Outflow Tube Set, forked suction, 3 per box
7211007	DYONICS 25 Day Tube Set (must be used with 7211008), 3 per box
7211008	DYONICS 25 Patient Tube Set (must be used with 7211007), 12 per box

### Accessories



REF	Description
7211011	LEVELERT <sup>®</sup> II Fluid Level Sensor
7211009	DYONICS 25 Luer-to-Colder Adaptor (InteliJET <sup>®</sup> cannula adaptor), 12 per box
72200891*	DYONICS 25 Wireless Remote, non-autoclavable
72201017	DYONICS 25 Wired Remote, non-autoclavable
7204483	Disposable multi bag adaptors ("Y" tubing), sterile, 2 to a set (6 sets per box)
8005600	U.S. power cord
8013378	U.K. power cord
8013380	International power cord
91000268	Shaver Interface Cable
91000290	Biomed test key

\* item shown

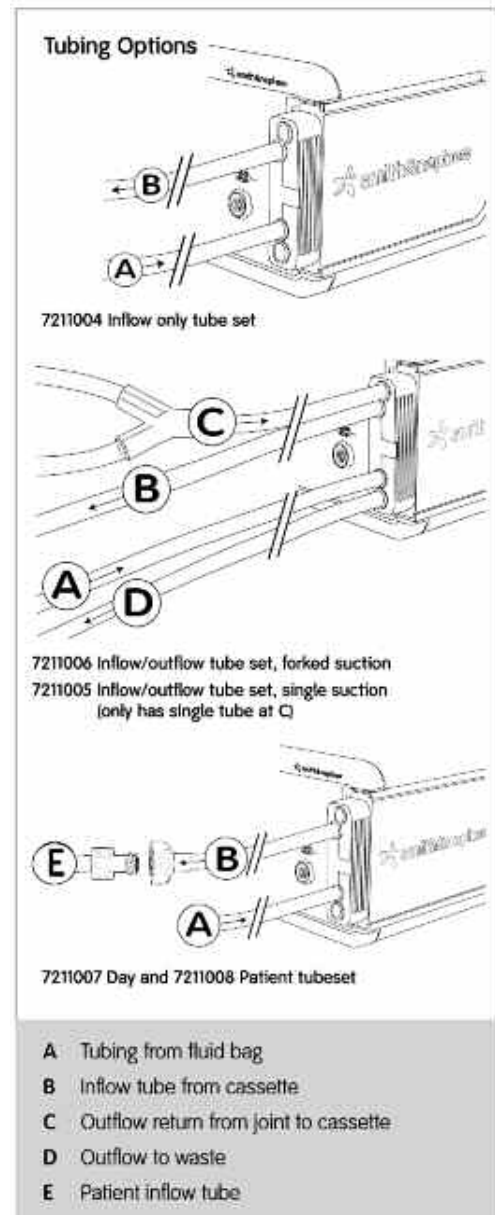

Call +1-800-343-5717 (U.S.) or contact your local representative.

## DYONICS<sup>◇</sup> 25 Carts

### DYONICS 25 Carts

REF	Description
7211014	Procedure Cart
72200747	Procedure cart with transformer and electrical outlets
72200888	Transformer upgrade kit (upgrades a 7211014 cart to a 72200747 cart)



## InteliJET<sup>®</sup> Tube Sets

### InteliJET Tube Sets

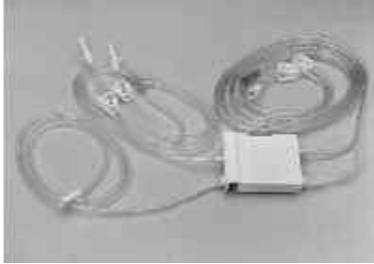

REF	Description
4298	Disposable Tubing Set, inflow/outflow forked suction, sterile, box of 3.
7205684*	Disposable Tubing Set, inflow/outflow, single suction line, sterile, box of 3 Inflow/outflow tubing with one suction line for direct connection to shaver
7204727	Disposable Tubing Set, inflow only, sterile, box of 3. With the inflow only tubing set, the InteliJET can be used as a stand-alone pump
7204483	Disposable multi bag adapters ("Y" tubing), sterile, 2 to a set (6 sets per box)

### InteliJET Accessories



REF	Description
7205392	Remote Control for InteliJET Control Unit, wireless, (uses 9V battery) Wireless Remote Control can be used from the operative field when placed in disposable, sterileplastic bag provided with each tubing set.



3982	LEVELERT <sup>®</sup> Fluid Level Sensor with cord for 120 VAC Control Unit
3982G	LEVELERT Fluid Level Sensor with cord for 230 VAC Control Unit
	LEVELERT Fluid Level Sensors allow the circulator to set the low fluid level indicator, which sounds when the fluid bags are low.

4353	Filters for Suction, box of 3
4423	Transducer (sensor) for InteliJET Control Unit
8012271	Replacement Protective Transducer Cap (metal)
8011678	Spring (behind transducer)

\* Item shown

## Smith & Nephew Access 15 Irrigation System



Maximum flow rate of 1.5 L/min for procedural speed and efficiency

Cost savings by conserving saline and reducing bag changes

Wireless remote control for full-system control from the sterile field

Remote foot pedal for easy operation of wash function

The Smith & Nephew Access 15 Irrigation System is the fast and easy system for accurate joint pressure management. The snap-on tubing cassette makes setup a simple one-hand operation. Advanced Flow Regulation (AFR) delivers optimal flow rates for stable and accurate in-joint pressure with any inflow setup. For optimum visualization, the system's wash function is designed both to clear debris and distend the joint immediately in the event of sudden fluid loss.

### Smith & Nephew Access 15 Irrigation System

REF	Description
7205933	Access 15 System, U.S., 150 mmHg, includes control unit, remote control, and power cord
7205935	Access 15 System, Intl. 200 mmHg, includes control unit, remote control, and power cord

### Smith & Nephew CONDOR®-Enabled Access 15 Irrigation System

7209781	CONDOR-Enabled Access 15 System, U.S., 150 mmHg, includes control unit, remote control, and power cord
7209782	CONDOR-Enabled Access 15 Control Unit, U.S., 150 mmHg
7209783	CONDOR-Enabled Access 15 System, Intl. 200 mmHg, includes control unit, remote control, and power cord
7209784	CONDOR-Enabled Access 15 Control Unit, Intl. 200 mmHg

### Smith & Nephew Access 15 Tube Sets

7205699	Inflow-only disposable tube set for use with the Access 15 Irrigation System, includes inflow-only tubing, sterile, box of 10
7205931	Inflow/Outflow disposable tube set for use with the Access 15 Irrigation System, includes inflow-only tubing, sterile, box of 10

### Smith & Nephew Access 15 Optional Accessories

7205797	Remote Control, wireless, operates all functions of the Access 15 Irrigation System. Additional remotes can be purchased separately
7204483	Disposable multi bag adapters ("Y" tubing), sterile, 2 to a set (6 sets per box)
7205798	Foot Pedal, operates wash function
7205932	Cart with irrigation poles to hang fluid bags



## ARTHROPAK<sup>®</sup> Customized Procedure Kit



### ARTHROPAK Customized Procedure Kit

Smith & Nephew DYONICS<sup>®</sup> ARTHROPAK Customized Procedure Kits provide increased operational efficiencies and reduced supply expense. You customize your kit with your selection of disposable Smith & Nephew products for any arthroscopic procedure at a reduced cost!

- Free customized service
- Reduced product cost
- Save valuable time and demand on staff
- Streamlined ordering process
- Increased standardization
- Reduced inventory

DYONICS ARTHROPAK Customized Procedure Kits reduce the number of SKUs that need to be ordered and aggregate purchasing volume of arthroscopic products by enabling purchase from a single supplier. Please ask your local sales representative to demonstrate how DYONICS ARTHROPAK Customized Procedure Kits can benefit your practice.

# G

Smith & Nephew ACUFEX® and ACUFEX Pro Punches .....G-1

Suction Punches .....G-5

Suction Punches/Accessories .....G-6

Smith & Nephew ACUFEX and ACUFEX Pro Scissors .....G-7

Smith & Nephew ACUFEX and ACUFEX Pro Graspers .....G-8

Smith & Nephew ACUFEX Small Joint Instruments .....G-10

Smith & Nephew ACUFEX Knives .....G-11

Probes .....G-12

Instrument Sterilization Trays .....G-13

Recommended Instrument Sets .....G-14

Care and Maintenance .....G-17

Made to Order .....G-18

    Punches.....G-18

    Scissors Punches, Graspers, Rongeurs, Knives, and Magnetic Retrievers.....G-20

    Small Joint Instruments, Micro Instruments, Curettes, Chondral Picks, and Sterilization Tray .....G-21

Smith & Nephew ACUFEX brand instruments offer the surgeon and the patient the benefits of superior performance. That's the ACUFEX hand-held difference.

Smith & Nephew offers a full line of ACUFEX punches, scissors, graspers, probes and knives that have earned a worldwide reputation for optimal maneuverability, sharpness, precision and strength.

All ACUFEX instruments are manufactured using the ACUFEX patented pinless hinge design, ensuring unsurpassed strength and cutting efficiency.

## Punches, Scissors, Graspers, and Knives

### Product Highlights



#### Meniscal Overbiter Punch

Specially designed with a reverse jaw that easily slides toward and under the superior meniscus flap region of the knee, an area notorious for its difficult access.

Meniscal Overbiter Punch  
Page G-7



#### Oval Punches

A family of punches that offers the lowest profile and the largest bite.

Oval Punches  
Page G-2



#### Graspers

ACUFEX handled graspers feature an "infinite position" sliding-lock mechanism that holds tissue firmly without tearing or slipping – even in the tightest areas.

Graspers  
Page G-8

## Smith & Nephew ACUFEX<sup>®</sup> and ACUFEX Pro Punches

Smith & Nephew ACUFEX punches are designed with a broad range of tips and configurations allowing easy access to specific areas of the meniscus.

Each linear punch is constructed with our exclusive pinless hinge design, one-piece outer shaft, and hand-honed edge to provide unrivaled strength, durability, and sharpness.

Having punches sharpened by a Smith & Nephew Service Center will ensure continued optimal cutting and will maximize the life of the instruments.

### Handle Selection Guide



**Loop Handle:** Scissors, basket punches, and graspers feature our traditional loop-style handles.



**ACUFEX Pro Handle:** Selected punches, scissors, and graspers feature this ergonomic handle design.



**Cigar Handle:** Available on rotary basket punches and scissors.



**ACUFEX Grasper Handle:** All ACUFEX graspers feature this infinite-position, locking-handle design.

### Shape Selection Guide



**Straight:** The primary style for direct approach



**Upbiter:** Angled 1/4 curve at tip for increased access to the posterior meniscus



**Upswept:** Angled shaft follows the contour of the condyle and keeps the cutting surface parallel to the tibial plateau





**Left and Right:** Angled to reach the anterior and posterior meniscus

## Smith & Nephew ACUFEX<sup>◇</sup> and ACUFEX Pro Punches



### Basket Punches – Narrowline

The narrow shaft and compact jaw design facilitates access and use in tight spaces, particularly useful in the posterior aspect of the knee.

	ACUFEX Pro REF	ACUFEX REF	Description	Tip Profile	Bite Width	Tip Width
	7207053	012052*	Straight	1.9 mm	1.67 mm	2.89 mm
	7207052	012051*	Upbiter	1.9 mm	1.67 mm	2.89 mm
	7207658	012053	Upbiter, curved left	1.9 mm	1.67 mm	2.89 mm
	7207660	012054	Upbiter, curved right	1.9 mm	1.67 mm	2.89 mm
	7207659	012055*	Upswept	1.9 mm	1.67 mm	2.89 mm
	7208679		45° tip, left	1.5 mm	1.67 mm	2.89 mm
	7208685		45° tip, right	1.5 mm	1.67 mm	2.89 mm

### Basket Punches – Duckbill

All-purpose, low-profile punches with a large square bite.

	ACUFEX Pro REF	ACUFEX REF	Description	Tip Profile	Bite Width	Tip Width
	7207057	012013*	Straight	2.52 mm	3.17 mm	5.05 mm
	7207058	012014*	Upbiter	2.52 mm	3.17 mm	5.05 mm
	7207667	012015	Upbiter, curved left	2.52 mm	3.17 mm	5.05 mm
	7207664	012016	Upbiter, curved right	2.52 mm	3.17 mm	5.05 mm

### Oval Punches

This family of punches offers the best of both worlds — the lowest profile and the largest bite, facilitating end-on and lateral cutting — the most versatile instrument available.

	7207083	7207200	Upbiter	1.65 mm	4.39 mm	6.57 mm
	7207181	7207201*	Straight	1.65 mm	4.39 mm	6.57 mm
	N/A	7207294	Curved left	1.65 mm	4.39 mm	6.57 mm
	N/A	7207295	Curved right	1.65 mm	4.39 mm	6.57 mm
	N/A	7207296	Upswept	1.65 mm	4.39 mm	6.57 mm

### Basket Punches – Blunt Nose

ACUFEX Loop Handle. Blunt nose basket punch enables flush contouring of meniscus.



	N/A	012035	1.0 mm, straight	1.83 mm	1.67 mm	3.32 mm
--	-----	--------	------------------	---------	---------	---------

\* Item shown

## Smith & Nephew ACUFEX<sup>◇</sup> and ACUFEX Pro Punches

### Basket Punches – DUCKLING<sup>◇</sup>

The Smith & Nephew ACUFEX DUCKLING punches are a lower-profile relation to the duckbill, maintaining a large square bite and maximizing maneuverability.

	ACUFEX Pro REF	ACUFEX REF	Description	Tip Profile	Bite Width	Tip Width
	7207049	012044*	Straight	1.93 mm	3.17 mm	5.00 mm
	7207050	012046	Curved left	1.93 mm	3.17 mm	5.00 mm
	7207051	012047	Curved right	1.93 mm	3.17 mm	5.00 mm
	7207668	014765	Elevator	1.93 mm	3.17 mm	5.00 mm
	7207000	012045*	Upbiter	1.93 mm	3.17 mm	5.00 mm
	7207672	012048	Upswept	1.93 mm	3.17 mm	5.00 mm

### Posterior Punches

For the specific requirements of the posterior horn of the meniscus; the short, low-profile jaw facilitates working in the tight confines of the posterior aspect of the knee.

	7207662	012201*	Upbiter	2.46 mm	2.18 mm	4.00 mm
	7207666	012202	Upswept	2.46 mm	2.18 mm	4.00 mm
	7207665	012203	Straight	2.46 mm	2.18 mm	4.00 mm
	7207661	012204	Curved left	2.46 mm	2.18 mm	4.00 mm
	7207663	012205	Curved right	2.46 mm	2.18 mm	4.00 mm

### Basket Punches – STINGRAY<sup>◇</sup>

These backbiters enable simple access to the anterior horn of the meniscus.



	7207055	012059	Left	3.93 mm	2.38 mm	5.58 mm	
	7207054	012058*	Right	3.93 mm	2.38 mm	5.58 mm	
	7210730	STINGRAY Basket Punch, right, length extended by 2.25"					
	7210731	STINGRAY Basket Punch, left, length extended by 2.25"					

\* Item shown

## Smith & Nephew ACUFEX<sup>◇</sup> and ACUFEX Pro Punches

### Basket Punches – Scoop



The most traditional style of instrument, a classical punch shape with the parrot beak upper jaw to help capture tissue.

	ACUFEX Pro REF	ACUFEX REF	Description	Tip Profile	Bite Width	Tip Width
	72200719	012029*	1.0 mm, straight	2.28 mm	1.59 mm	3.25 mm
	7207657	012040	1.3 mm, curved left	2.10 mm	1.59 mm	3.27 mm
	7207656	012041	1.3 mm, curved right	2.10 mm	1.59 mm	3.27 mm
	72200716	012030	1.3 mm, upbiter	2.10 mm	1.59 mm	3.27 mm
	N/A	012042	1.3 mm, upbiter, curved left	2.10 mm	1.59 mm	3.27 mm
	N/A	012043	1.3 mm, upbiter, curved right	2.10 mm	1.59 mm	3.27 mm
	N/A	012031*	1.3 mm, upswept	2.10 mm	1.59 mm	3.27 mm
	N/A	012033	1.3 mm, downbiter	2.10 mm	1.59 mm	3.27 mm
	7207046	012034	1.5 mm, straight	2.28 mm	1.59 mm	3.88 mm
	N/A	012020*	1.5 mm, upbiter	2.28 mm	1.59 mm	3.88 mm
	N/A	012032	1.5 mm, upswept	2.28 mm	1.59 mm	3.88 mm
	N/A	012011	2.7 mm, straight	2.28 mm	1.77 mm	3.58 mm
	N/A	012012	3.4 mm, straight	2.94 mm	2.03 mm	3.76 mm

Note: The dimensions given refer to the height of the lower jaw at the distal end.

### Basket Punches – Meniscal Elevator

The extended lip of the lower jaw assists in placing the lower jaw underneath less-mobile menisci.

	N/A	012060	1.3 mm, straight
	7207671*	012061	1.3 mm, upbiter

### Basket Punches – 90° Rotary

90° Rotary 2.2 mm – tip profile 3.36 mm, bite width 3.17 mm, tip width 6.79 mm

90° Rotary 3.4 mm – tip profile 3.86 mm, bite width 3.17 mm, tip width 6.79 mm





	Loop Handle REF	Cigar Handle REF	Description
	010912*	010906	2.2 mm, left
	010913	010907	2.2 mm, right
	N/A	010900	3.4 mm, left
	N/A	010901	3.4 mm, right

\* Item shown

## Suction Punches

### DYOVAC® Suction Punches

Offers the dual convenience of resecting tissue while simultaneously evacuating through a suction channel in the instrument.

	REF	Description
	3499	2.5 mm, straight
	2685	5.2 mm, straight
	2707*	3.4 mm, straight
	3196*	4.5 mm, 90° left
	3197	4.5 mm, 90° right

\* Item shown

## Suction Punches/Accessories

### Blade Retention Screws

Box of 12



REF	Description
2714*	For 3.4 mm suction punch
2699	For 5.2 mm suction punch

### Replacement Blades

REF	Description
3585	For 3.4 mm suction punch, 1 each
3586	For 5.2 mm suction punch, 1 each

### Cleaning Brushes

Box of 10

2715	For 3.4 mm suction punch
2697	For 5.2 mm suction punch
3349	For 4.5 mm suction punch
3577	For 2.5 mm suction punch





## Smith & Nephew ACUFEX<sup>◇</sup> and ACUFEX Pro Scissors

Smith & Nephew ACUFEX scissors are constructed without pins for maximum strength, dependability, durability, and safety.

A wide range of tips and angles enable the surgeon to effectively dissect any part of the meniscus from virtually any direction.

### Rotary Scissors

	Loop Handle REF	Cigar Handle REF	Description
	010814*	010800	20° hooked, left
	010815	010801	20° hooked, right
	010812*	010802	60° hooked, left
	010813	010803	60° hooked, right
	010816*	N/A	20° short, serrated, left
	010817	N/A	20° short, serrated, right
	N/A	010806	20° serrated, left
	N/A	010807*	20° serrated, right

### Scissors Punches

	ACUFEX Pro REF	ACUFEX REF	Description
	7207047	012036	Straight
	7207048	012037	Upbiter
	7207669	012038*	Upbiter, curved left
	7207670	012039	Upbiter, curved right

### Meniscal OVERBITER<sup>◇</sup> Punch

Used where access is required into superior meniscal flap region.

	ACUFEX Pro REF	ACUFEX REF	Description
	N/A	7209878	Overbiter

\* Item shown

## Smith & Nephew ACUFEX<sup>◇</sup> and ACUFEX Pro Graspers

A broad selection of procedure-specific tip configurations provide maximum grasping capability and allow easy access to all areas of the meniscus from a variety of approaches.

ACUFEX Grasper Handled Graspers feature an “infinite position” sliding-lock mechanism that holds tissue firmly without tearing or slipping — even in the tightest areas.

Locking mechanism is not available on ACUFEX Pro.

### Graspers – Loosebody Forceps



ACUFEX Pro REF	ACUFEX REF	Description
7207061	011022	PITBULL <sup>◇</sup>

### Graspers – Cupped



N/A	011012	2.7 mm
7207059*	011014	3.4 mm
N/A	7207700	3.4 mm, length extended by 2.25"

### Rongeur



Loop Handle REF	Description
014720*	RAPTOR <sup>◇</sup>
014843	RAPTOR Jr.



\* Item shown

## Smith & Nephew ACUFEX<sup>◇</sup> and ACUFEX Pro Graspers



ACUFEX Grasper Handled Graspers feature an “infinite position” sliding-lock mechanism that holds tissue firmly without tearing or slipping — even in the tightest areas.

Locking mechanism is not available on ACUFEX Pro.

### Graspers – Alligator

	ACUFEX Pro REF	ACUFEX REF	Description	Tip Profile	Tip Width
	7207060*	011020	2.7 mm, straight	2.66 mm	3.05 mm
	7207673	011021	2.7 mm, upcurved	2.66 mm	3.05 mm
	N/A	011024*	Alligator max	3.17 mm	3.45 mm
	N/A	7207699	Alligator max, length extended by 2.25"	3.17 mm	3.45 mm

### Graspers – Atraumatic





	N/A	011030	Tissue tensioner, straight		
	N/A	014779	Cannulated tissue tensioner, straight		

\* Item Shown

## Smith & Nephew ACUFEX<sup>®</sup> Small Joint Instruments

### Small Joint Arthroplasty Instruments

Shorter shafts and lower profile tips meet the specific demands of the small-joint surgeon. Available individually or in a convenient system with a dedicated tray.

	REF	Description
	014843	RAPTOR <sup>®</sup> Jr. Punch
	014844	Blunt Nose Jr. punch
	014845	PITBULL <sup>®</sup> Jr. grasper
	013219	Small joint grasper

### Small Joint Instruments – DYOVAC<sup>®</sup> Suction Punches

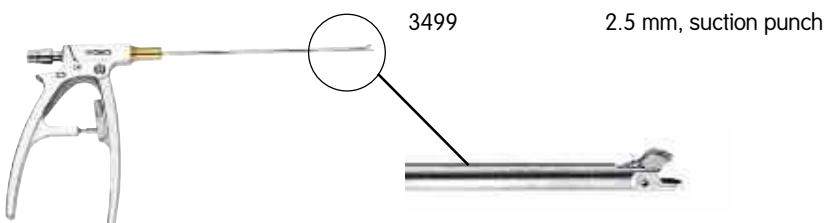









### Small Joint Probes

	REF	Description
	3856	Probe, 3 mm
	3312	Hook probe
	7209134	ELITE <sup>®</sup> calibrated probe

## Smith & Nephew ACUFEX<sup>®</sup> Knives

### ACUFEX Knives





	REF	Description
	010600	Hook - 3.0 mm straight, disposable <sup>†</sup> , box of 5
	010161*	Hook - 5.0 mm straight, reusable
	010610	Rosette - 3.0 mm straight, disposable <sup>†</sup> , box of 5
	010630	Banana - 3.0 mm, serrated, straight, disposable <sup>†</sup> , box of 5
	010121*	Banana - 5.0 mm, serrated, straight, reusable
	010620	Meniscectomy - 3.0 mm, round tip, straight, disposable <sup>†</sup> , box of 5
	010640	Meniscectomy - 3.0 mm, serrated flat, straight, disposable <sup>†</sup> , box of 5
	010650	Meniscectomy - 3.0 mm, sharp tip, straight, disposable <sup>†</sup> , box of 5
	010660	Meniscectomy - 3.0 mm, V-shaped, straight, disposable <sup>†</sup> , box of 5
	010680	Reusable handle for disposable knife

<sup>†</sup> Disposable knives are supplied as a box of 5, single-use, sterile packs.

\* Item shown

## Probes

## Probes

		REF	Description
		010001*	Straight
		010525	Cannular, 3.0 mm, straight
		010002*	Curved, left 30°
		010003	Curved, right 30°
		7204869	3.0 mm, heavy hook (with handle)

\* Item shown

Call +1-800-343-5717 (U.S.) or contact your local representative.

## Instrument Sterilization Trays

### Sterilization Trays

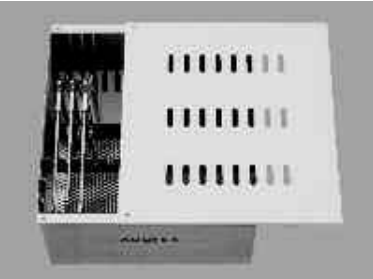
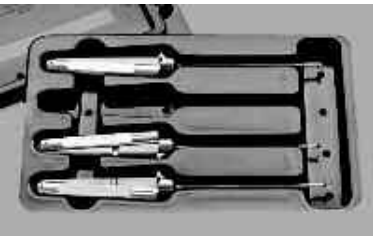
	REF	Description
	7207161*	Smith & Nephew ACUFEX <sup>®</sup> Pro Seven-Unit Sterilization Tray (for ACUFEX Pro, ProLine, or ACUFEX hand held instruments)
	7207162	Smith & Nephew ACUFEX <sup>®</sup> Pro Fifteen-Unit Sterilization Tray (for ACUFEX Pro, ProLine, or ACUFEX hand held instruments)
	011673	Linear Instruments Fifteen-Unit Sterilization Tray
	7209334	25-unit metal sterilization tray
<i>ALL trays are sold as a unit - tops and bottoms are NOT available separately</i>		
	011695*	Rotary Instruments Four-Unit Sterilization Tray
	011694	Arthroplasty Instruments Seven-Unit Sterilization Tray

\* Item shown

## Recommended Instrument Sets

### Recommended Handheld Instruments For Starter Set

Build a seven instrument starter set based on your access needs to specific areas of the meniscus.  
(All instruments are sold separately)

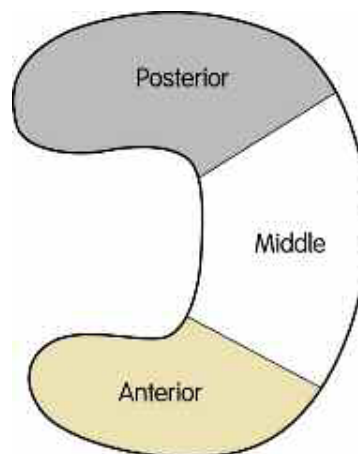

#### Anterior

ACUFEX Pro Handle REF	ACUFEX Loop Handle REF	Description
7207055	012059	STINGRAY® Basket Punch, left
7207054	012058	STINGRAY, Basket Punch, right
N/A	010912	90° Rotary Basket Punch, 2.2 mm, left
N/A	010913	90° Rotary Basket Punch, 2.2 mm, right

#### Anterior, Middle, Posterior

7207181	7207201	Oval Punch, straight
7207057	012013	Duckbill Basket Punch, straight

#### Middle & Posterior

7207049	012044	Duckling Basket Punch, straight
7207000	012045	Duckling Basket Punch, upbiter
7207058	012014	Duckbill Basket Punch, upbiter
7207047	012036	Scissors Punch, straight

#### Posterior

7207052	012051	Narrowline Basket Punch, upbiter
7207662	012201	Posterior, upbiter

#### Grasper, Probe & Tray

REF	Description
011024	2.7 mm Alligator Max Grasper
010001	Straight Probe
7207161	Seven-Unit Sterilization Tray



## Recommended Instrument Sets

### Recommended Handheld Instruments For Comprehensive Set

Build a fifteen instrument starter set based on your access needs to specific areas of the meniscus.  
(All instruments are sold separately)

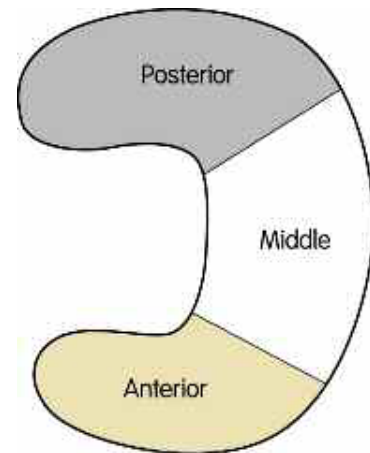

#### Anterior

ACUFEX Pro Handle REF	ACUFEX Loop Handle REF	Description
7207055	012059	STINGRAY® Basket Punch, left
7207054	012058	STINGRAY, Basket Punch, right
N/A	010912	90° Rotary Basket Punch, 2.2 mm, left
N/A	010913	90° Rotary Basket Punch, 2.2 mm, right

#### Anterior, Middle, Posterior

7207181	7207201	Oval Punch, straight
7207057	012013	Duckbill Basket Punch, straight

#### Middle & Posterior

7207049	012044	Duckling® Basket Punch, straight
7207000	012045	Duckling Basket Punch, upbiter
7207058	012014	Duckbill Basket Punch, upbiter
7207047	012036	Scissors Punch, straight
N/A	012035	Blunt Nose Basket Punch, 1.0 mm, straight
N/A	012020	Scoop Basket Punch, 1.5 mm, upbiter
N/A	012032	Scoop Basket Punch, 1.5 mm, upswept

## Recommended Instrument Sets

### Recommended Handheld Instruments For Comprehensive Set

#### Posterior

ACUFEX® Pro Handle REF	ACUFEX Loop Handle REF	Description
7207053	012052	Narrowline Basket Punch, straight
7207052	012051	Narrowline Basket Punch, upbiter
7207658	012053	Narrowline Basket Punch, upbiter, Curved Left
7207660	012054	Narrowline Basket Punch, upbiter, Curved Right
7207659	012055	Narrowline Basket Punch, upswept
7207662	012201	Posterior, upbiter
7207666	012202	Posterior Punch, upswept
7207665	012203	Posterior Punch, straight
7207661	012204	Posterior Punch, curved left
7207663	012205	Posterior Punch, curved right

#### Graspers

N/A	011024	2.7 mm Alligator Max Grasper
7207061	011022	PITBULL® Loosebody Forceps

#### Probe & Tray

REF	Description
010001	Straight Probe
7207162	ACUFEX Pro® Fifteen-Unit Sterilization Tray
011673	Linear Instruments Fifteen-Unit Sterilization Tray

## Care and Maintenance

The shafts and tips of ACUFEX® Instruments are of specially formulated and treated surgical stainless steel for optimum sharpness and resistance to corrosion. However, correct care and maintenance are important in optimizing the performance of your instruments. Please use the information here to protect your investment.

### Cleaning

Whenever possible, use demineralized, distilled water, when cleaning your instruments. Mineral deposits and impurities in tap water can lead to corrosion. For washing, use a detergent or solution pH (7.0 to 11.0) for safe cleaning. Ultrasonic cleaners may be used to clean your instruments. After cleaning, dry the instruments to prevent water impurities from collecting on surfaces. Replace the instruments in the ACUFEX Sterilization Trays between uses to protect the instrument tips.

### Lubrication

To protect instruments from staining and rusting prior to sterilization or storage, dip instruments into a water-soluble antimicrobial lubricant, following manufacturer's instructions. The lubricant will help to free stiff instruments; if dipping does not free an instrument, try soaking it overnight.

### Resharpener/Preventative Maintenance

Instruments need to be inspected and evaluated on a regular basis to determine whether resharpener, realignment, or refurbishment is needed. Routine service will aid in promoting proper function and performance. Only sharpening by Smith & Nephew can maintain and restore the sharpness of the cutting blade or tip to our original manufacturing specifications. Regular maintenance and the use of a Smith & Nephew facility for resharpener will increase the life of the instruments.

## Made to Order Punches

Made to Order products have longer production times. Please contact your sales representative or customer service for more information.

### Basket Punches – Narrowline

REF	Description
7207658	Upbiter, curved left, ACUFEX® Pro Handle
7207659	Upswept, ACUFEX Pro Handle
7207660	Upbiter, curved right, ACUFEX Pro Handle
7207552	Upswept, with larger finger and thumb loops
7207053	Straight, ACUFEX Pro Handle
7207052	Upbiter, ACUFEX Pro Handle

### Basket Punches – Duckbill

7207664	Upbiter, curved right, ACUFEX Pro Handle
7207667	Upbiter, curved left, ACUFEX Pro Handle

### Basket Punches – DUCKLING®

7207668	Elevator, ACUFEX Pro Handle
7207000	Upbiter
7207672	Upswept, ACUFEX Pro Handle
7205979	Upswept, low profile extended 20 mm
7207547	Duckling, 20° downbiter

### Basket Punches – Posterior

7207665	Straight, ACUFEX Pro Handle
7207666	Upswept, ACUFEX Pro Handle
7207661	Upbiter, curved left, ACUFEX Pro Handle
7207662	Upbiter, ACUFEX Pro Handle
7207663	Upbiter, curved right, ACUFEX Pro Handle

### Basket Punches – Scoop

72200719	1.0 mm, straight, ACUFEX Pro Handle
7207657	1.3 mm, curved left, ACUFEX Pro Handle
7207656	1.3 mm, curved right, ACUFEX Pro Handle
72200716	1.3 mm, upbiter, ACUFEX Pro Handle

### Basket Punches – Meniscal Elevator

7207671	1.3 mm, upbiter, ACUFEX Pro Handle
---------	------------------------------------

## Made to Order Punches

Made to Order products have longer production times. Please contact your sales representative or customer service for more information.

### Basket Punches – Oval

REF	Description
3134238	Curved left at 40 mm from tip
7207533	Upbiter, with larger finger and thumb loops

### Basket Punches – Extended Length

7207737	Duckling, upswept, length extended by 2.25"
7207733	Narrowline upbiter, length extended by 2.25"
7207734	Narrowline upbiter, curved right, length extended by 2.25"

## Made to Order

### Scissors Punches, Graspers, Rongeurs, Knives, and Magnetic Retrievers

Made to Order products have longer production times. Please contact your sales representative or customer service for more information.

#### Scissors Punches

REF	Description
7207669	Upbiter, curved left, ACUFEX® Pro Handle
7207670	Upbiter, curved right, ACUFEX Pro Handle

#### Graspers

7207673	2.7 mm upcurved grasper, Alligator, ACUFEX Pro Handle
3134239	Grasper, cupped, 3.4 mm, no teeth
6900595Z	Grasper, Johnson Jaw, 130 mm long
7205983	Grasper, Johnson Jaw Jr., 130 mm long

#### Rongeur

7207553	RAPTOR® rongeur with larger finger and thumb loops
7210757	RAPTOR Jr., down swept 10°

#### Rongeur – Extended Length

7207732	RAPTOR rongeur, length extended by 2.25"
---------	--

#### Knives – Reusable

3134216	3.0 mm, straight, sharp tip
3134217	5.0 mm, straight, sharp tip

#### Magnetic Retrievers

011501	3.0 mm, curved, 30°
011502	4.0 mm, straight

## Made to Order

### Small Joint Instruments, Micro Instruments, Curettes, Chondral Picks, and Sterilization Tray

Made to Order products have longer production times. Please contact your sales representative or customer service for more information.

#### Scissors Punches

REF	Description
3134236	Small joint probe
3134237	Small joint elevator

#### Micro Instruments

7210753	Micro-grasper, straight, down swept 10°
7210754	Micro-punch, straight, down swept 10°
7210755	Teardrop punch, right, down swept 10°
7210756	Teardrop punch, left, down swept 10°

#### Curettes

3134240	Curette, closed 3.0 mm, extended 4 cm shaft
3134266	Curette, NOTCHMASTER®, 6.0 mm

#### Chondral Picks

6900833	Chondral pick, 3.5 mm, 45° bend
6900834	Chondral tamp, 3.5 mm, 45° tip

#### Sterilization Tray

7209334	25-unit Sterilization Tray
---------	----------------------------



## Knee Arthroscopy

Meniscal Repair Systems.....	H-1
ULTRA FAST-FIX <sup>®</sup> (all inside) .....	H-1
FAST-FIX (all inside) .....	H-1
T-FIX <sup>®</sup> (all inside) .....	H-2
Meniscus Mender II (outside-in) .....	H-3
Meniscal Stitcher Set (inside-out) .....	H-4
Diamond Rasps .....	H-5
ACL/PCL Fixation Systems .....	H-6
ENDOBUTTON <sup>®</sup> CL ULTRA	
Fixation Device .....	H-6
ENDOBUTTON DIRECT	
Fixation Device .....	H-6
ENDOBUTTON <sup>®</sup> CL BTB Fixation Device..	H-7
XTENDOBUTTON Fixation Device .....	H-7
CL Device.....	H-8
ENDOBUTTON Fixation Device .....	H-8
Graft Sleeves .....	H-9
WHIPKNOT <sup>®</sup> Soft Tissue Cinch .....	H-9
BIORCI <sup>®</sup> -HA Screws .....	H-10
BIORCI Screws.....	H-11
BIORCI Screw Instrumentation System ..	H-12
BIOSURE <sup>®</sup> -HA Interference Screw.....	H-13
RCI Screws.....	H-15
RCI Screw Instrumentation System .....	H-16
ENDO-FIX <sup>®</sup> L Screw System .....	H-18
SOFTSILK <sup>®</sup> Screw Systems .....	H-20
Screw Cannulas and Screw Fixation .....	H-21
TRAILBLAZER <sup>®</sup> Wire Guides, Screw	
Guides, and Screw Guide Wires .....	H-22
Spiked Washer/Tibial Anchor .....	H-23
Fixation Posts .....	H-24
Suture Fixation.....	H-25
Graft Harvesting/Preparation .....	H-26
Graft Harvesting Instruments .....	H-26
GRAFTMASTER <sup>®</sup> II and GTS	
Preparation Systems .....	H-27
ACL/PCL Reconstruction	
Drill Guide Systems.....	H-29
Clancy Anatomic Cruciate	
Guide/Flexible Drill System .....	H-29
ACUFEX <sup>®</sup> Anatomic ACL	
Guide Systems .....	H-29
ACUFEX Director ACL System Sets .....	H-31
ACL Revision REDUX <sup>®</sup> System .....	H-36
TRE-CORE <sup>®</sup> Trepine System .....	H-38
TUNDRA ACL/PCL Aimer System .....	H-39
ACUFEX <sup>®</sup> Director PCL System.....	H-40
ACL/PCL Drill Guide System	
Components & Accessories .....	H-41
ACUFEX <sup>®</sup> Director System Set	
Components.....	H-41
Offset Guides and Aimers.....	H-43
Rear Entry Components .....	H-44
MULTI-TRAC <sup>®</sup> Components.....	H-45
Drill Bits, Routers & Bone Graft	
Compressors .....	H-46
Sizing Tubes, Dilators, and Blocks .....	H-49
ACL Arthroplasty Instruments .....	H-50
PCL Arthroplasty Instruments .....	H-52
MCL MicroPerforation Instruments .....	H-53
Bone Tunnel Plugs.....	H-53
Isometry .....	H-54
Cruciate Pins and Wires .....	H-55
Cruciate Accessory Pacs.....	H-57
Chondral Resurfacing Systems .....	H-62
MOSAICPLASTY <sup>®</sup> .....	H-62
Chondral Picks.....	H-63
Cruciate Reconstruction .....	H-64
Leg Holder, Pads and Inserts .....	H-64
ARTHROPAK <sup>®</sup> .....	H-65
Customized Procedure Kit.....	H-65



# Knee Arthroscopy

## Product Highlights



### ENDOBUTTON® Fixation Device Family

ENDOBUTTON Fixation Devices have become the trusted choice and market leading solution for femoral fixation.

ENDOBUTTON Family  
Page H-6

### ULTRA FAST-FIX® Meniscal Repair System

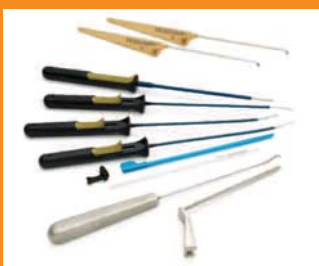

Easy to slide, hard to break. All inside meniscal repair system with ULTRABRAID® suture, provides exceptional fixation strength and easier knot sliding.

FAST-FIX Meniscal Repair System  
Page H-1

### BIOSURE® HA Interference Screw



Our most multifunctional family of screws ever.

BIOSURE HA Interference Screw  
Page H-13

## Meniscal Repair Systems

### ULTRA FAST-FIX<sup>®</sup> (all inside)

#### Easy to slide, hard to break

The new ULTRA FAST-FIX, all inside meniscal repair system now with ULTRABRAID<sup>®</sup> suture provides exceptional fixation strength and easier knot sliding. With pre-loaded implants, a pre-tied, self-sliding knot, the ULTRA FAST-FIX System enables you to efficiently deploy two implants vertical or horizontal on the superior or tibial surface of the meniscus.

REF	Description
72201491	ULTRA FAST-FIX, curved
72201492	ULTRA FAST-FIX, reverse curved
72201494	ULTRA FAST-FIX AB, curved
72201495	ULTRA FAST-FIX AB, reverse curved
72201490	ULTRA FAST-FIX, straight
72201493	ULTRA FAST-FIX, AB, straight
72201537	Knot Pusher/Suture Cutter, straight
72201538	Knot Pusher/Suture Cutter, curved
015186	Meniscal Depth Probe
014549	45° Diamond Rasp
014550	90° Diamond Rasp
011703	Sterilization Tray, 9.25" x 3" x 1.5"
Optional:	
7210977	Slotted Cannula
7209950	Suture Threaders, sterile, box of 10
7210450	Suture Funnel, sterile, box of 10



### FAST-FIX

7207876	FAST-FIX, straight
7207877	FAST-FIX, curved
7209205	FAST-FIX, reverse curved
7209398	FAST-FIX AB, straight
7209399	FAST-FIX AB, curved
7209858	FAST-FIX AB, reverse curved
7209084	Straight Knot Pusher/Suture Cutter, sterile, disposable, 1 package
7210076	Curved Knot Pusher/Suture Cutter, sterile, disposable, 1 package

## Meniscal Repair Systems

### T-FIX<sup>®</sup> (all inside)

#### T-FIX Suture Bar

For all inside meniscal repair; 1.0 mm x 6.3 mm Delrin bar on #2-0 braided polyester.

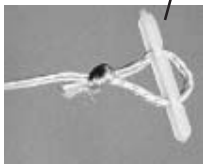
	REF	Description
	015182*	1 T-FIX/pack single suture, curved introducer, sterile
	015180*	1 T-FIX/pack double suture, straight introducer, sterile
	015181	1 T-FIX/pack single suture, straight introducer, sterile
		

#### T-FIX Instrumentation

	015184	Intra-articular Knot Pusher
	015186	Meniscal Depth Probe, 2 mm markings
	014527	T-FIX Suture Cutter, for up to #2-0 suture
	014623	Cannula Kit, 5 mm I.D. x 55 mm, includes trocar and obturator, sterile, single-use, box of 10

\* Item shown

## Meniscal Repair Systems

### Meniscus Mender II (outside-in)

#### Meniscus Mender II

The Meniscus Mender II, an outside-in suture technique that is designed for repairing the meniscus under direct arthroscopic monitoring. Ideal for anterior horn tears.



REF	Description
7209485*	MMII Disposable Set
Optional Components:	
7209477	Straight Suture Passer
7209478	Curved Suture Passer
7209481	Suture Circle
7207357	Large Sterilization Tray with mat (13"L x 8"W x 1.25"H)
7209480	Set Screw for Suture Passer, large
7209483	Set Screw for Suture Passer, small
7209485*	MMII Disposable Set

\* Item shown

## Meniscal Repair Systems

### Meniscal Stitcher Set (inside-out)



#### Meniscal Stitcher Set

For inside-out meniscal repair

REF	Description
012600	Meniscal Stitcher Set
System includes:	
012601	Double Lumen Cannula, curved up-right
012602	Double Lumen Cannula, curved up-left
012603	Double Lumen Cannula, straight
012604	Double Lumen Cannula, curved left/right
012605	Double Lumen Cannula, curved up/down
012606	Single Cannula (2 included with set)
012609	Thimble
012610	Posterior Access Cannula
012612	Bending Tool
011702	Sterilization Tray for Meniscal Stitcher Set
Disposables:	
012608	Needles, straight, non-sterile, package of 6

#### Meniscal Stitching Needles



REF	Description
012615	Ti-Cron® 10" swaged needles with #2-0, 30" long suture, for Meniscal Stitcher Set; non-absorbable, single use, sterile, box of 12



012608	10" Straight Replacement Needles for Meniscal Stitcher Set; uses suture size USP #2-0, non-sterile, package of 6
--------	--

## Meniscal Repair Systems

### Diamond Rasps



#### Diamond Rasps

Designed specifically to freshen the edge of the meniscal tear prior to repair.

	REF	Description
	014549	45° Diamond Rasp
	014550	90° Diamond Rasp

## ACL/PCL Fixation Systems

### ENDOBUTTON® CL ULTRA Fixation Device

Delivering improved strength and stiffness, the ENDOBUTTON CL ULTRA Fixation device offers the strongest soft tissue femoral fixation currently available. Ideal for anatomic or traditional ACL reconstruction techniques. Preloaded with polyester braided sutures (No. 5 lead and No. 2 flipping) for added procedure efficiency.



REF	Description
72200146	ENDOBUTTON CL ULTRA System 15 mm
72200147	ENDOBUTTON CL ULTRA System 20 mm
72200148	ENDOBUTTON CL ULTRA System 25 mm
72200149	ENDOBUTTON CL ULTRA System 30 mm
72200150	ENDOBUTTON CL ULTRA System 35 mm
72200151	ENDOBUTTON CL ULTRA System 40 mm
72200152	ENDOBUTTON CL ULTRA System 45 mm
72200153	ENDOBUTTON CL ULTRA System 50 mm
72200154	ENDOBUTTON CL ULTRA System 55 mm
72200155	ENDOBUTTON CL ULTRA System 60 mm

### ENDOBUTTON DIRECT Fixation Device

The titanium ENDOBUTTON device maximizes the amount of graft in the tunnel, an ideal solution for accommodating shorter femoral tunnels that result from more anatomic placement.



REF	Description
72201206	ENDOBUTTON DIRECT 5 mm
72201207	ENDOBUTTON DIRECT 6 mm
72201208	ENDOBUTTON DIRECT 7 mm
72201209	ENDOBUTTON DIRECT 8 mm
72201210	ENDOBUTTON DIRECT 9 mm
72201212	ENDOBUTTON DIRECT Holder
72201600	ENDOBUTTON DIRECT Scale

## ACL/PCL Fixation Systems

### ENDOBUTTON® CL BTB Fixation Device

ENDOBUTTON CL BTB provides dependable fixation for bone-tendon-bone ACL reconstruction procedures.



REF	Description
7210080	ENDOBUTTON CL BTB 20 mm
7210081	ENDOBUTTON CL BTB 25 mm
7210082	ENDOBUTTON CL BTB 30 mm
7210083	ENDOBUTTON CL BTB 35 mm
7210084	ENDOBUTTON CL BTB 40 mm
7210085	ENDOBUTTON CL BTB 45 mm
7210086	ENDOBUTTON CL BTB 50 mm
7210087	ENDOBUTTON CL BTB 55 mm
7210088	ENDOBUTTON CL BTB 60 mm

### XTENDOBUTTON Fixation Device

The Smith & Nephew XTENDOBUTTON Fixation Device, used in conjunction with any Smith & Nephew ENDOBUTTON device, allows a 6 to 10 mm area of the femoral tunnel to be covered. In addition to providing an effective solution for cortical blowouts, this feature offers a variety of benefits to surgeons.



REF	Description
72200134	XTENDOBUTTON Fixation Device



## ACL/PCL Fixation Systems

### CL Device

Continuous loop of suture eliminates the need for knot tying. Ideal for a post or screw-and-washer technique.

REF	Description
72200839	CL Device 25 mm
72200840	CL Device 30 mm
72200841	CL Device 35 mm
72200842	CL Device 40 mm
72200843	CL Device 45 mm
72200844	CL Device 50 mm



### ENDOBUTTON<sup>®</sup> Fixation Device



This titanium button is the original endoscopic femoral soft tissue fixation device, and where the ENDOBUTTON revolution began. It can be used for single incision, soft tissue, or bone-tendon-bone fixation

REF	Description
013186	ENDOBUTTON, 4.0 mm x 12 mm

### ENDOBUTTON Tape

The only surgical tape cleared for use with ENDOBUTTON Fixation Device

REF	Description
014868	ENDOBUTTON Tape with Passing Needle, 24" (60 cm), box of 12



REF	Description
7207315	Endoscopic Cannulated Drill bit, 4.5 mm (use with ENDOBUTTON, ENDOBUTTON CL, or RCI screws), sterile, disposable, single use



015185	ENDOBUTTON Depth Probe
7209951	ENDOBUTTON Adjustable Knob for Depth Probe
3134301	Cannulated Depth Probe (Made to Order with longer production times)

## ACL/PCL Fixation Systems

### Graft Sleeve



REF	Description
7210038	GTS Sleeve
7210039	GTS 7 mm x 30 mm Tapered Screw
7210040	GTS 8 mm x 30 mm Tapered Screw
7208656	GTS Screw Driver

NOTE: GTS instruments listed on page H-25

### WHIPKNOT® Soft Tissue Cinch

The WHIPKNOT Soft Tissue Cinch is indicated for use in assisting in the harvest, preparation, and placement of soft tissue grafts during ligament reconstructive surgical procedures. Packaged pre-assembled in a sterile pack that includes a disposable cannula.



REF	Description
7211015	WHIPKNOT, #5 Soft Tissue Cinch, sterile, box of 1

## ACL/PCL Fixation Systems

### BIORCI®-HA Screws



#### BIORCI-HA Screw System Implants

The BIORCI-HA Screw System has proven effectiveness for graft fixation and site repair. BIORCI-HA screws use standard BIORCI instruments and offer 23 screw sizes to choose from.



REF	Description
7207686	Screw, BIORCI PLA/HA 7/7 x 20 mm
7207674	Screw, BIORCI PLA/HA 7/7 x 25 mm
7207677	Screw, BIORCI PLA/HA 7/7 x 30 mm
7207675	Screw, BIORCI PLA/HA 7/8 x 25 mm
7207676	Screw, BIORCI PLA/HA 7/8 x 30 mm
7209012	Screw, BIORCI PLA/HA 8 x 20 mm
7207678	Screw, BIORCI PLA/HA 8 x 25 mm
7207679	Screw, BIORCI PLA/HA 8 x 30 mm
7207680	Screw, BIORCI PLA/HA 8 x 35 mm
7209013	Screw, BIORCI PLA/HA 9 x 20 mm
7207681	Screw, BIORCI PLA/HA 9 x 25 mm
7207682	Screw, BIORCI PLA/HA 9 x 30 mm
7207683	Screw, BIORCI PLA/HA 9 x 35 mm
7209016	Screw, BIORCI PLA/HA 10 x 25 mm
7209017	Screw, BIORCI PLA/HA 10 x 30 mm
7209018	Screw, BIORCI PLA/HA 10 x 35 mm
7209014	Screw, BIORCI PLA/HA 11 x 30 mm
7209022	Screw, BIORCI PLA/HA 11 x 35 mm
7209015	Screw, BIORCI PLA/HA 12 x 35 mm
7209023	Screw, BIORCI PLA/HA 7/8 x 25 mm, reverse thread
7209021	Screw, BIORCI PLA/HA 8 x 25 mm, reverse thread
7209020	Screw, BIORCI PLA/HA 9 x 25 mm, reverse thread
7209019	Screw, BIORCI PLA/HA 10 x 25 mm, reverse thread
7207636	1.5 mm x 9" (23 cm) Guide Wire, non-sterile, package of 6
014859	1.5 mm x 12" (30 cm) Guide Wire, sterile, package of 1

## ACL/PCL Fixation Systems

### BIORCI® Screws

#### BIORCI Screws

PLLA Bioabsorbable Interference Screws, 1.5 mm cannulation, blunt threads, standard and enlarged heads, sterile, 1 per box.

	REF	Description
	7207916	7 x 20 mm BIORCI Screw
	7207554*	7 x 25 mm BIORCI Screw
	7207607	7 x 25 mm reverse thread BIORCI Screw with an 8 mm head
	7207555	7 x 30 mm BIORCI Screw
	7207557	7 x 25 mm BIORCI Screw with an 8 mm head
	7207558	7 x 30 mm BIORCI Screw with an 8 mm head
	7207918	8 x 20 mm BIORCI Screw
	7207560	8 x 25 mm BIORCI Screw
	7207608*	8 x 25 mm reverse thread BIORCI Screw
	7207561	8 x 30 mm BIORCI Screw
	7207562	8 x 35 mm BIORCI Screw
	7207919	9 x 20 mm BIORCI Screw
	7207563	9 x 25 mm BIORCI Screw
	7207924	9 x 25 mm reverse thread BIORCI Screw
	7207564	9 x 30 mm BIORCI Screw
	7207565	9 x 35 mm BIORCI Screw
	7207566	10 x 25 mm BIORCI Screw
	7207581	10 x 25 mm reverse thread BIORCI Screw
7207567	10 x 30 mm BIORCI Screw	
7207568*	10 x 35 mm BIORCI Screw	
7207920	11 x 30 mm BIORCI Screw	
7207921	11 x 35 mm BIORCI Screw	
7207923	12 x 35 mm BIORCI Screw	

\* Item shown

## ACL/PCL Fixation Systems

### BIORCI® Screw Instrumentation System

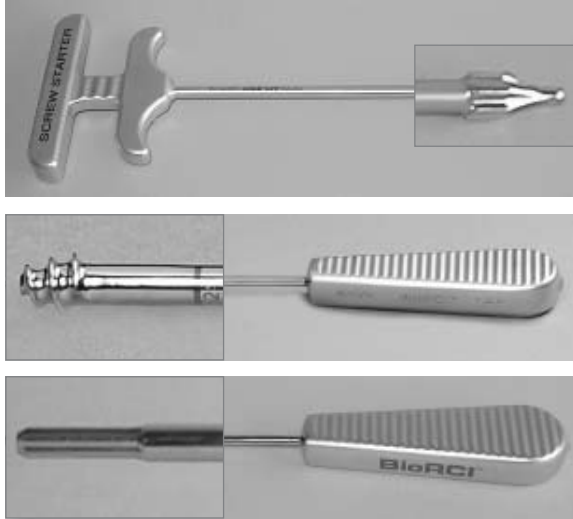

#### BIORCI Screw Instruments

REF	Description
7208656*	BIORCI Torx Driver
7207359*	BIORCI Starter
7209371	7.0 mm BIORCI Threaded Screw Starter for BTB grafts
7209373*	8.0 mm BIORCI Threaded Screw Starter for BTB grafts
7207369	Medium Sterilization Tray for System without Taps
7207357	Large Sterilization Tray for System with Taps
7208661	7.0 mm BIORCI tap for BTB grafts
7208662	8.0 mm BIORCI tap for BTB grafts
7208663	9.0 mm BIORCI tap for BTB grafts
7208664	10 mm BIORCI tap for BTB grafts
7207636	1.5 mm x 9" Guide Wire, non-sterile (package of 6)
014859	1.5 mm x 12" Guide Wire, single use
7207707	Handle with Hudson adaptor

#### Made to Order

Made to Order products have longer production times. Please contact your sales representative or customer service for more information.

7207783	BIORCI Ratcheting Handle System (includes REF 7207707 Ratcheting handle with Hudson adaptor and REF 7207754 Driver with Hudson adaptor)
7207754	Driver, BIORCI and BIORCI-HA, with Hudson Adaptor
6901012	BIORCI Driver, 3" extended length, with Hudson Adaptor
3134295	BIORCI Driver, with set screw to secure guide wire, with Hudson Adaptor
3134214	Driver, Tapered, 3.5 mm hex, non-cannulated

\* Item shown

## ACL/PCL Fixation Systems

### BIOSURE<sup>®</sup>-HA Family



#### BIOSURE-HA Interference Screw

The BIOSURE-HA family of interference screws gives you an all-purpose range of screws and instrumentation. Incorporating the latest proven technologies to help you deliver exceptional graft fixation. Available in 24 sizes, including 6 mm screws for double mode repairs and reverse thread screws for right knees.

REF	Description
72201768	Screw, BIOSURE-HA 6 mm x 20 mm
72201769	Screw, BIOSURE-HA 6 mm x 25 mm
72201770	Screw, BIOSURE-HA 6 mm x 25 mm, Reverse Thread
72201771	Screw, BIOSURE-HA 7 mm x 20 mm
72201772	Screw, BIOSURE-HA 7 mm x 25 mm
72201773	Screw, BIOSURE-HA 7 mm x 25 mm, Reverse Thread
72201774	Screw, BIOSURE-HA 7 mm x 30 mm
72201775	Screw, BIOSURE-HA 8 mm x 20 mm
72201776	Screw, BIOSURE-HA 8 mm x 25 mm
72201777	Screw, BIOSURE-HA 8 mm x 25 mm, Reverse Thread
72201778	Screw, BIOSURE-HA 8 mm x 30 mm
72201779	Screw, BIOSURE-HA 8 mm x 35 mm
72201780	Screw, BIOSURE-HA 9 mm x 20 mm
72201781	Screw, BIOSURE-HA 9 mm x 25 mm
72201782	Screw, BIOSURE-HA 9 mm x 30 mm
72201783	Screw, BIOSURE-HA 9 mm x 35 mm
72201784	Screw, BIOSURE-HA 10 mm x 20 mm
72201785	Screw, BIOSURE-HA 10 mm x 25 mm
72201786	Screw, BIOSURE-HA 10 mm x 30 mm
72201787	Screw, BIOSURE-HA 10 mm x 35 mm
72201788	Screw, BIOSURE-HA 11 mm x 25 mm
72201789	Screw, BIOSURE-HA 11 mm x 30 mm
72201790	Screw, BIOSURE-HA 11 mm x 35 mm
72201791	Screw, BIOSURE-HA 12 mm x 35 mm

## ACL/PCL Fixation Systems

### BIOSURE<sup>®</sup>-HA Family

#### BIOSURE-HA Guide Wires

REF	Description
7211137	Guide Wire, 1.2 mm x 9" Box of 5 Sterile
7211138	Guide Wire, 1.2 mm x 12" Box of 5 Sterile
72201201	Guide Wire, 1.2 mm x 18" Box of 5 Sterile

#### BIOSURE-HA Drivers

REF	Description
72201887	BIOSURE Driver
72201888	BIOSURE Ratchet Driver (requires part number 7207707)
7207707	Ratcheting Handle with Hudson Adaptor

#### BIOSURE-HA Tap System

REF	Description
72201889	BIOSURE Tap 6mm
72201890	BIOSURE Tap 7mm
72201891	BIOSURE Tap 8mm
72201892	BIOSURE Tap 9mm
72201893	BIOSURE Tap 10mm
72201887	BIOSURE Driver
72201938	BIOSURE Tap Tray

#### BIOSURE-HA EASY Tap System

REF	Description
72201190	BIOSURE EASY Tap 6 mm
72201191	BIOSURE EASY Tap 7 mm
72201192	BIOSURE EASY Tap 8 mm
72201193	BIOSURE EASY Tap 9 mm
72201194	BIOSURE EASY Tap 10 mm
72201888	BIOSURE Ratchet Driver
7207707	Ratcheting Handle with Hudson Adapter
72201939	BIOSURE EASY Tap Tray

#### BIOSURE-HA Notcher System

REF	Description
72201622	6 mm Notcher Guide
72201623	7 mm Notcher Guide
72201624	8 mm Notcher Guide
72201625	9 mm Notcher Guide
72201626	10 mm Notcher Guide
72201568	Notcher Tap
72201569	Notcher Tap, reverse thread
722001940	Notcher Tray

## ACL/PCL Fixation Systems

### RCI Screws

#### 2.0 mm Cannulation RCI Screws

Titanium, 2.0 mm cannulation, blunt threads, standard and enlarged heads, sterile.



REF	Description
7207030	7 x 25 mm RCI Screw with 8 mm head
7207247	7 x 25 mm reverse thread RCI Screw
7209409	7 x 35 mm RCI Screw with 8 mm head
7207250	7 x 40 mm RCI Screw
7207248	8 x 25 mm RCI Screw
7209410	8 x 25 mm reverse thread RCI Screw
7209411	8 x 35 mm RCI Screw
7207249	8 x 40 mm RCI Screw
7207301	9 x 25 mm RCI Screw
7209412	9 x 35 mm RCI Screw
7209779	10 x 25 mm RCI Screw
7209413	10 x 30 mm RCI Screw
7209414	10 x 35 mm RCI Screw
7209415	11 x 30 mm RCI Screw
7209416	11 x 35 mm RCI Screw

#### Made to Order

Made to Order products have longer production times. Please contact your sales representative or customer service for more information.

REF	Description
-----	-------------

#### Cannulated Screw (with 1.0 mm cannulation, Titanium)

7204767	5 x25 mm cannulated screw
7204770	6 x25 mm cannulated screw
7204771	6 x30 mm cannulated screw

#### RCI (with 2.0 mm cannulation, Titanium)

7207722	11 x 30 mm RCI Screw, non-sterile
7207719	11 x 35 mm RCI Screw, non-sterile

#### Soft-Threaded (with 2.0 mm cannulation)

3134257	7 x 35 mm soft-threaded, non-sterile
3134255	8 x 35 mm soft-threaded, non-sterile

#### RCI Screw Instruments

3134091	3.5 mm Hex Driver, Nitinol Tip, with Hudon Adaptor. For 7 x 20 mm screws only
3134092	3.5 mm Hex Driver, Nitinol Tip, with Hudon Adaptor
3134299	3.5 mm Hex Driver, 1.5 mm cannulation, shortened 2.2" with Hudson Adaptor
6901177	3.5 mm Hex Driver, Nitinol Tip, thin shaft, with Hudon Adaptor



## ACL/PCL Fixation Systems

### RCI Screw Instrumentation System

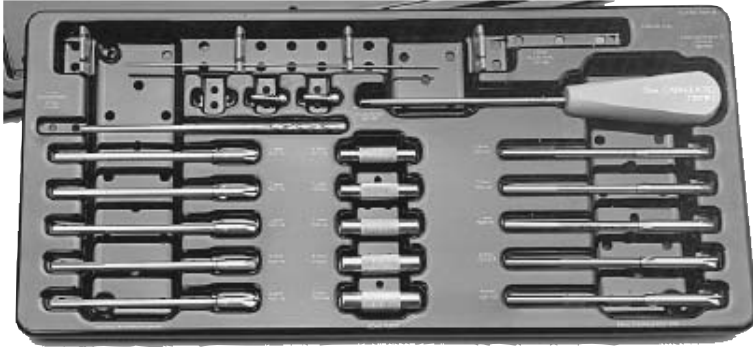

#### RCI Screw System

The RCI Screw is a patented device for use in cruciate reconstruction when using hamstring or patellar tendon grafts. The RCI Screw has blunt threads that protect the grafts from laceration. The round head on the 7 x 25 mm screws reduces the stresses in the graft as it exits the femoral tunnel.

REF	Description
7207170	RCI Screw System
System includes:	
7207163	6.5 mm graft sizing tube
013523	7.0 mm graft sizing tube
7207164	7.5 mm graft sizing tube
013524	8.0 mm graft sizing tube
7207165	8.5 mm graft sizing tube
7207167	6.5 mm tibial stepped router
7207168	7.0 mm tibial stepped router
7207171	7.5 mm tibial stepped router
7207172	8.0 mm tibial stepped router
7207173	8.5 mm tibial stepped router
7207174	6.5 mm femoral stepped router
7207175	7.0 mm femoral stepped router
7207176	7.5 mm femoral stepped router
7207177	8.0 mm femoral stepped router
7207178	8.5 mm femoral stepped router
7207193	3.5 mm Hex Driver, 2.0 mm cannulation
7207169	Sterilization Tray for RCI Screw System
7207160	CANNU-FLEX® Screw Guide Wire, 2 mm x 9" (23 cm), blunt tip, non-sterile, package of 6
013184	Endoscopic Cannulated Drill, 4.5 mm, non-sterile

## ACL/PCL Fixation Systems

### ENDO-FIX<sup>®</sup> L Screw System

#### ENDO-FIX L Screw System

Poly L lactic acid

Fixation strength of metal — without metal in the joint

1.5 mm cannulation

Indicated for bone-tendon-bone and soft tissue fixation



REF	Description
	ENDO-FIX L Screw System components:
014542	7.0 mm ENDO-FIX L Tap
7208667	8.0 mm ENDO-FIX L Tap
014543	9.0 mm ENDO-FIX L Tap
7207359*	ENDO-FIX L Screw Starter
7207358*	ENDO-FIX L Driver, 1.5 mm cannulation
7207369	Sterilization Tray for ENDO-FIX L Delivery System

#### ENDO-FIX L Bioabsorbable Interference Screws

PLLA Bioabsorbable Interference Screws, 1.5 mm cannulation, sterile, 1 per box.

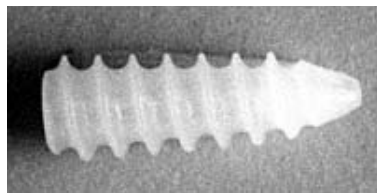

7207480	7 mm diameter x 20 mm, tapered 6.5 mm to 7.5 mm
7207481	7 mm diameter x 25 mm, tapered 6.5 mm to 8.3 mm
7208665	8 mm diameter x 20 mm, tapered 7.5 mm to 8.3 mm
7208666*	8 mm diameter x 25 mm, tapered 7.5 mm to 9.1 mm
7207477	9 mm diameter x 20 mm, tapered 8.6 mm to 9.4 mm
7207478	9 mm diameter x 25 mm, tapered 8.6 mm to 10.2 mm
7207479	9 mm diameter x 30 mm, tapered 8.6 mm to 10.6 mm

#### Made to Order

Made to Order products have longer production times. Please contact your sales representative or customer service for more information.

REF	Description
-----	-------------

#### ENDO-FIX L Screw Instruments

3134016	Tap, 7.0 mm ENDO-FIX L, with Hudson Adaptor
3134015	Tap, 9.0 mm ENDO-FIX L, with Hudson Adaptor

\* Item shown

## ACL/PCL Fixation Systems

### SOFTSILK<sup>®</sup> Screw Systems



#### SOFTSILK 1.5 Screw System

REF	Description	REF	Description
7207077	SOFTSILK 1.5 Screw System Sterile screws (3 of each size included with system) System includes:		
7207001	7 x 20 mm SOFTSILK 1.5	014815	3.5 mm Hex Driver, 2.0 mm cannulation
7207002	7 x 25 mm SOFTSILK 1.5	014851	TRAILBLAZER <sup>®</sup> , 1.5 mm cannulation
7207003	7 x 30 mm SOFTSILK 1.5	014545	CANNU-FLEX <sup>®</sup> Screw Guide Wire, 1.5 mm x 12" (30 cm), package of 6
7207004	8 x 20 mm SOFTSILK 1.5		
7207005	8 x 25 mm SOFTSILK 1.5	7205514	Sterilization Tray for SOFTSILK 1.5 Screw System
7207006	8 x 30 mm SOFTSILK 1.5	Optional:	
7207007	9 x 20 mm SOFTSILK 1.5	7207704	3.5 mm Hex Driver, 1.5 mm cannulation, with Hudson Adapter, requires REF 7207707
7207008	9 x 25 mm SOFTSILK 1.5		
7207009	9 x 30 mm SOFTSILK 1.5		

#### SOFTSILK 1.5 Fixation Screws

Titanium, 1.5 mm cannulation, round head, corkscrew tip, soft threads, sterile.



REF Screw only	REF Sheathed in CLEAR-TRAC <sup>®</sup> Screw Cannula; latex-free	REF Sheathed in CLEAR-TRAC <sup>®</sup> Screw Cannula; contains latex	Description
7207001	7205640	7210131	7 x 20 mm SOFTSILK 1.5
7207002	7205643	7210132	7 x 25 mm SOFTSILK 1.5
7207003	7205644	7210133	7 x 30 mm SOFTSILK 1.5
7207004	7205641	7210134	8 x 20 mm SOFTSILK 1.5
7207005	7205645	7210135	8 x 25 mm SOFTSILK 1.5
7207006	7205646	7210136	8 x 30 mm SOFTSILK 1.5
7207007	7205642	7210137	9 x 20 mm SOFTSILK 1.5
7207008	7205647	7210138	9 x 25 mm SOFTSILK 1.5
7207009	7205648	7210139	9 x 30 mm SOFTSILK 1.5

## ACL/PCL Fixation Systems

### SOFTSILK<sup>®</sup> Screw Systems

#### Made to Order

Made to Order products have longer production times. Please contact your sales representative or customer service for more information.

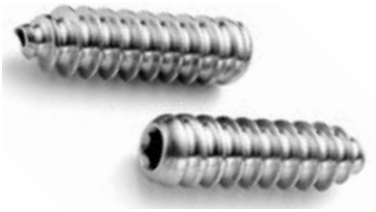

**SOFTSILK 1.5 Fixation Screws – sterile**  
Titanium, 1.5 mm cannulation, round head, corkscrew tip, soft threads, sterile.

REF	Description
7210760	10 x 25 mm SOFTSILK 1.5
7210762	11 x 25 mm SOFTSILK 1.5
7210764	12 x 25 mm SOFTSILK 1.5
7210767	12 x 40 mm SOFTSILK 1.5
7210745	13 x 25 mm SOFTSILK 1.5
7210746	13 x 30 mm SOFTSILK 1.5
7210747	13 x 35 mm SOFTSILK 1.5
7210748	13 x 40 mm SOFTSILK 1.5

## ACL/PCL Fixation Systems

### SOFTSILK<sup>®</sup> Screw Systems



#### SOFTSILK 2.0 Screw System

REF	Description
7207154	SOFTSILK 2.0 Screw System Sterile screws (3 of each size included with system) System includes:
7207256	7 x 20 mm SOFTSILK 2.0
7207257	7 x 25 mm SOFTSILK 2.0
7207258	7 x 30 mm SOFTSILK 2.0
7207259	8 x 20 mm SOFTSILK 2.0
7207260	8 x 25 mm SOFTSILK 2.0
7207261	8 x 30 mm SOFTSILK 2.0
7207262	9 x 20 mm SOFTSILK 2.0
7207263	9 x 25 mm SOFTSILK 2.0
7207264	9 x 30 mm SOFTSILK 2.0
7207268	3.5 mm Hex Driver, 2.0 mm cannulation
7205658	CANNU-FLEX <sup>®</sup> Screw Guide Wire, 1.5 mm x 12" (30 cm), package of 6
7207196	Sterilization Tray for SOFTSILK 1.5 Screw System
	Optional:
7207705	Driver, 2.0 mm cannulation, 3.5 hex, with Hudson adaptor Requires REF 7207707 Ratcheting handle with Hudson adaptor

#### SOFTSILK 2.0 Fixation Screws

Titanium, 2.0 mm cannulation, round head, corkscrew tip, soft threads, sterile.



REF Screw only	REF Sheathed in CLEAR-TRAC <sup>®</sup> Screw Cannula; latex-free	REF Sheathed in CLEAR-TRAC <sup>®</sup> Screw Cannula; contains latex	Description
7207256	7205649	7210140	7 x 20 mm SOFTSILK 2.0
7207257	7205650	7210141	7 x 25 mm SOFTSILK 2.0
7207258	7205651	7210142	7 x 30 mm SOFTSILK 2.0
7207259	7205652	7210143	8 x 20 mm SOFTSILK 2.0
7207260	7205653	7210144	8 x 25 mm SOFTSILK 2.0
7207261	7205654	7210145	8 x 30 mm SOFTSILK 2.0
7207262	7205655	7210146	9 x 20 mm SOFTSILK 2.0
7207263	7205656	7210147	9 x 25 mm SOFTSILK 2.0
7207264	7205657	7210148	9 x 30 mm SOFTSILK 2.0

## ACL/PCL Fixation Systems

### Screw Cannulas and Screw Fixation

#### CLEAR-TRAC® Screw Cannulas

Provides graft protection and aids screw delivery during graft fixation. Sterile, single use.



REF	Description
7207227	7.0 mm CLEAR-TRAC Screw Cannula, latex-free, box of 10
7207228	8.0 mm CLEAR-TRAC Screw Cannula, latex-free, box of 10
7207229	9.0 mm CLEAR-TRAC Screw Cannula, latex-free, box of 10
7210118*	7.0 mm CLEAR-TRAC Screw Cannula, contains latex, box of 10
7210119	8.0 mm CLEAR-TRAC Screw Cannula, contains latex, box of 10
7210120	9.0 mm CLEAR-TRAC Screw Cannula, contains latex, box of 10

#### CANNU-FLEX® SILK® 1.0 Screws – Uses 1.0 mm CANNU-FLEX Guide Wire

REF Sterile	REF Screwdriver	Description
014206	014270	6 mm x 20 mm
014207	014270	6 mm x 25 mm
014208	014270	6 mm x 30 mm
014200	014270	7 mm x 20 mm
014201	014270	7 mm x 25 mm
014202	014270	7 mm x 30 mm
014813	014270	8 mm x 20 mm
014814	014270	8 mm x 25 mm
014203	014271	9 mm x 20 mm
014204	014271	9 mm x 25 mm
014205	014271	9 mm x 30 mm

#### Made to Order

Made to Order products have longer production times. Please contact your sales representative or customer service for more information.

REF	Description
-----	-------------

#### Fluid seals

7205122	Fluid seals for 7.0 mm, 8.0 mm, 9.0 mm, and 10 mm cannulas, non-sterile, autoclavable, package of 25
---------	--

\* Item shown

## ACL/PCL Fixation Systems

### TRAILBLAZER® Wire Guides, Screw Guides, and Screw Guide Wires

#### TRAILBLAZER Wire Guide

Provides delivery of the CANNU-FLEX® Screw Guide Wire while creating a de-rotational slot for the screw.



REF	Description
014417	TRAILBLAZER, cannulated, uses 1 mm guide wire
014851	TRAILBLAZER, 1.5 mm cannulation

#### Screw Guides

Compatible with CANNU-FLEX SILK® 1.0 and ACUFEX® Non-Cannulated Interference Screws.



014662*	7.0 mm, SILK Escort
014816	9.0 mm, SILK Escort

#### Screw Guide Wires

Single use, includes 20 mm, 25 mm, and 30 mm calibration marks to assist in screw placement.



014394	CANNU-FLEX Screw Guide Wires, 1.0 mm x 12" (30 cm), Nitinol, blunt tip, sterile
014403	CANNU-FLEX Screw Guide Wires, 1.0 mm x 12" (30 cm), Nitinol, blunt tip, non-sterile, package of 6
013443	Stainless Steel Guide Wires, 1.0 mm x 12" (30 cm), trocar tip, non-sterile, package of 6
013475	CANNU-FLEX Screw Guide Wires, 1.0 mm x 9" (23 cm), Nitinol, trocar tip, non-sterile, package of 6
014859	CANNU-FLEX Screw Guide Wire, 1.5 mm x 12" (30 cm), blunt tip, sterile
014545	CANNU-FLEX Screw Guide Wire, 1.5 mm x 12" (30 cm), blunt tip, non-sterile, package of 6
7207636	CANNU-FLEX Screw Guide Wire, 1.5 mm x 9" (23 cm), blunt tip, non-sterile, package of 6
7207160	Stainless Steel Guide Wires, 2.0 mm x 9" (23 cm) blunt tip, non-sterile, package of 6
7205658	CANNU-FLEX Screw Guide Wire, 2.0 mm x 12" (30 cm), blunt tip, non-sterile, package of 6
7205659	CANNU-FLEX Screw Guide Wire, 2.0 mm x 12" (30 cm) blunt tip, sterile
7207222	CANNU-FLEX Screw Guide Wire, 2.0 mm x 15" (38 cm) blunt tip, sterile







\* Item shown

## ACL/PCL Fixation Systems

### Spiked Washer/Tibial Anchor

#### Spiked Washer/Tibial Anchor

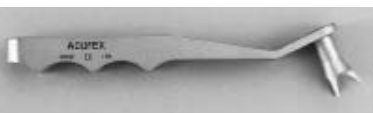
The Smith & Nephew ACUFEX® Spiked Washer/Tibial Anchor is an implant system specifically designed for securing soft tissue tendons to cortical bone. Its primary function is for securing a doubled, looped Semi-T/Gracilis graft (DLSTG) onto the tibial cortex.

	REF	Description
	7207725*	Spiked Washer, 17 mm, sterile Designed for use with Tibial Anchor REF 7207186
	7207726*	Spiked Washer, 21 mm, sterile
	7208717	Suture Washer, 14 mm, sterile
	3134281	Suture Washer (U.S. only)
	7208681*	Stabilizer Wrench
	7207186	Tibial Anchor, 9 x 25 mm, sterile Designed for use in conjunction with REF 7207725. Requires Tibial Anchor Driver REF 014924.
	014925*	Tibial Anchor, 4.5 mm, Drill Bit Built in depth stop is designed to be used with the Tibial Anchor Drill Guide REF 014927. The 25 mm depth calibration also allows it to be used without the guide.
	3134135	Tibial Anchor, 5.5 mm, Drill For use in hard bone <b>without</b> the Tibial Anchor Drill Guide.
	014927	Tibial Anchor Drill Guide Quickly and accurately produces a 25 mm deep perpendicular hole when used with the Tibial Anchor Drill Bit REF 014925.
	014924	Tibial Anchor, 3.5 mm, Hex Driver Unique hex design assures secure engagement into both portions of the Tibial Anchor REF 7207186.
	011703	Small Sterilization Tray

\* Item shown



## ACL/PCL Fixation Systems

### Fixation Posts



#### Fixation Post System

Flat head design eliminates need for washer when tying sutures around a post.

Low profile design improves patient comfort.

REF	Description
014465	Fixation Post System
System includes:	
013124	Fixation Post Driver with Holder, 3 mm Hex
013177	Fixation Post Tap
013479Z	Fixation Post Depth Gauge (Made to Order products have longer production times. Please contact your sales representative or customer service for more information.)
011804	Sterilization Tray for Fixation Post System
014695	2.4 mm Drill, disposable

#### Fixation Posts – Sterile

Titanium suture post



REF	Description
013140*	4.5 mm x 25 mm
013141	4.5 mm x 30 mm
013142	4.5 mm x 35 mm
013143	4.5 mm x 40 mm
013144	4.5 mm x 45 mm
013145	4.5 mm x 50 mm
013146	4.5 mm x 55 mm

\* Item shown

## ACL/PCL Fixation Systems

### Suture Fixation

#### Suture Washers

Titanium button for fixating grafts with sutures, non-sterile



REF	Description
7204791	15 mm Suture Washer
7204792	17 mm Suture Washer

#### Fixation Buttons

Delrin button for fixating grafts with sutures, sterile

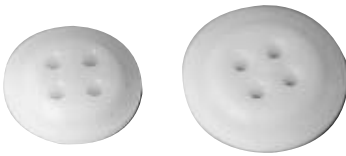

REF	Description
013635	14 mm Fixation Buttons, box of 6
013636	17 mm Fixation Buttons, box of 6

## Graft Harvesting/Preparation

### Graft Harvesting Instruments

#### Tendon Strippers

Used for semitendinosus and gracilis graft harvesting.

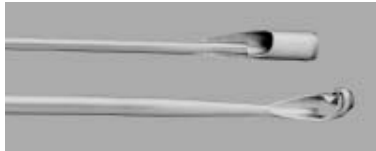

REF	Description
7207179	Large Tendon Stripper, closed, 7.4 mm I.D. x 13.5" working length
013550*	Tendon Stripper, closed, 6.4 mm I.D. x 12" working length
013554*	Tendon Stripper, slotted, 5.0 mm I.D. x 12" working length

#### Patellar Tendon Saw Guides

Sized guides for marking and harvesting patellar tendons for cruciate reconstruction.



7205637	9.0 mm Saw Guide
7205638*	10 mm Saw Guide
7205639	11 mm Saw Guide

#### COMPACTION Pliers

Helps shape the bone-tendon-bone grafts used in ACL/PCL reconstruction. The actual size of the COMPACTION Pliers is .75 mm smaller than the stated size. This permits easy insertion of the graft into the femoral tunnel and allows for bone memory.



7209441	7.0 mm COMPACTION Pliers
7209442	8.0 mm COMPACTION Pliers
7209443	9.0 mm COMPACTION Pliers
7209446	10 mm COMPACTION Pliers
7209447	11 mm COMPACTION Pliers
7209448	12 mm COMPACTION Pliers

## Graft Harvesting/Preparation

### GRAFTMASTER<sup>®</sup> II and GTS Preparation Systems



#### GRAFTMASTER II System

Instruments for graft preparation

REF	Description
014948	GRAFTMASTER II System
System Includes:	
014949	GRAFTMASTER II Board
014415	ENDOBUTTON <sup>®</sup> Holder
014950	GRAFTMASTER II Sliding Base
014413	Suture Vise
7207692	Full Length Cutting Strip
7207182	Sterilization Tray for GRAFTMASTER II System

#### Optional Components:

7209951	ENDOBUTTON Adjustable Knob for Depth Probe
015185	ENDOBUTTON Depth Probe
6900880	Depth probe laser marked to 180 mm ( <b>Made to order</b> with longer production time)

#### GTS Preparation System





The Smith & Nephew GTS System offers technologically advanced instruments to assist surgeons during ACL reconstruction procedures. More than just a means of simplifying the technique, this system is able to effectively anchor and compress soft tissue grafts, giving surgeons the confidence of a strong, accurate fixation.

REF	Description
7209926	Graft Tensioning Device
7209862	Tensioning Device Holder
7209721	ENDOBUTTON <sup>®</sup> Holder Scale Extender

## Graft Harvesting/Preparation

### GRAFTMASTER® II and GTS Preparation Systems

#### Optional Components

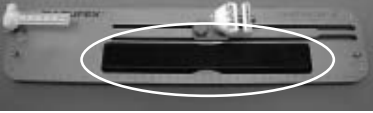
	REF	Description
	014414	Suture Vise with Tensiometer, allows the pre-tensioning of grafts
	357280	Replacement shoulder screw
	40000202	Replacement small flat headed screw
	014412	Tissue Grasper (two recommended)
	357246	Replacement thumbwheel nut
	400235	Replacement Gaskets
	7207342	Tensioning Post Ideal for pretensioning grafts when using the ENDOBUTTON® CL
	7207692	Full Length Cutting Strip Only for use on GRAFTMASTER II Boards with integral suture posts
	014953	GRAFTMASTER II Cutting Strip, for use on all GRAFTMASTER II Boards
	72201212	ENDOBUTTON DIRECT Holder
	72201600	ENDOBUTTON Direct Scale

## ACL/PCL Reconstruction Drill Guide Systems

### Clancy Anatomic Cruciate Guide/Flexible Drill System

Clancy Anatomic Cruciate Guide/Flexible Drill System reproduces more accurate anatomic femoral tunnel placements without hyperflexing the knee and utilizes the anterior medial portal.



REF	Description
7209008	7.0 mm Flexible Drill
7209737	8.0 mm Flexible Drill
7209738	9.0 mm Flexible Drill
7209739	10 mm Flexible Drill
3134008	Endoscopic Femoral Guide, 2.7 mm I.D., 42°
72201594	2.4 mm Flexible Passing Pins, Sterile, package of 5
014803	Endoscopic Femoral Guide Handle (Also available in the ACUFEX® Director Set)

## ACUFEX<sup>®</sup> Anatomic ACL Guide System

ACUFEX Anatomic ACL Guide System for double bundle ACL reconstruction lets you restore the anatomic footprints of the AM and PL bundles. You can drill independent and diverging bone tunnels on the femoral and tibial side of the knee joint with consistent, reproducible separation.



REF	Description
72201252	ACUFEX Anatomic ACL Guide System
Set Includes:	
72201240	PL Femoral Aimer Handle
72201974	5 mm PL Femoral Aimer Post
72201975	5.5 mm PL Femoral Aimer Post
72201241	6 mm PL Femoral Aimer Post
72201976	6.5 mm PL Femoral Aimer Post
72201242	7 mm PL Femoral Aimer Post
72201977	7.5 mm PL Femoral Aimer Post
72201243	8 mm PL Femoral Aimer Post
72201978	8.5 mm PL Femoral Aimer Post
72201244	9 mm PL Femoral Aimer Post
72201245	Left, PL Tibial Aimer Handle
72201246	Right, PL Tibial Aimer Handle
72201969	5 mm PL Tibial Aimer Post
72201970	5.5 mm PL Tibial Aimer Post
72201247	6 mm PL Tibial Aimer Post
72201971	6.5 mm PL Tibial Aimer Post
72201248	7 mm PL Tibial Aimer Post
72201972	7.5 mm PL Tibial Aimer Post
72201249	8 mm PL Tibial Aimer Post
72201973	8.5 mm PL Tibial Aimer Post
72201250	9 mm PL Tibial Aimer Post
6900854	Non-cannulated Drill Bit, 4.5 mm
72201253	Anatomic ACL Double Bundle Instrument Tray

## ACL/PCL Reconstruction Drill Guide Systems

### ACUFEX<sup>®</sup> Director ACL System Sets

#### ACUFEX<sup>®</sup> DIRECTOR ELITE Drill Guide System

The Smith & Nephew ACUFEX DIRECTOR ELITE Drill Guide System is a complete system of instruments for the accurate, reproducible placement and drilling of tibial and femoral tunnels during single-incision ACL reconstruction. The system components are sized for both bone-tendon-bone and soft tissue grafts.



REF	Description
72201746	ACUFEX DIRECTOR ELITE ACL Drill Guide System
System includes:	
7205517	ACUFEX DIRECTOR Drill Guide Requires: 1 Aimer and 1 Bullet (not included, see pg. H-39 and H-40)
	7205518 ACUFEX DIRECTOR ACL Elbow Aimer
	7205519 ACUFEX DIRECTOR ACL Tip Aimer
	7205524 ACUFEX DIRECTOR Angled Bullet
	7205525 ACUFEX DIRECTOR 4-Point Bullet
013498	5.0 mm Cannulated Drill
7207491	5.5 mm Cannulated Drill
013542	6.0 mm Cannulated Drill
7207483	6.5 mm Cannulated Drill
013543	7.0 mm Cannulated Drill
7207484	7.5 mm Cannulated Drill
013544	8.0 mm Cannulated Drill
7207485	8.5 mm Cannulated Drill
013545	9.0 mm Cannulated Drill
013546	10 mm Cannulated Drill
013547	11 mm Cannulated Drill
013548	12 mm Cannulated Drill
013498	5.0 mm Endoscopic Drill
7207482	5.5 mm Endoscopic Drill
013499	6.0 mm Endoscopic Drill
7207492	6.5 mm Endoscopic Drill
013660	7.0 mm Endoscopic Drill
7207493	7.5 mm Endoscopic Drill
013661	8.0 mm Endoscopic Drill
7207494	8.5 mm Endoscopic Drill
013662	9.0 mm Endoscopic Drill
013663	10 mm Endoscopic Drill
013664	11 mm Endoscopic Drill
013665	12 mm Endoscopic Drill

REF	Description
7220732	Universal EndoFemoral Aimer
72201737	EndoFemoral Aimer, no Offset
72201713	3.0 mm Offset EndoFemoral Aimer
72201714	4.0 mm Offset EndoFemoral Aimer
72201715	5.0 mm Offset EndoFemoral Aimer
72201716	6.0 mm Offset EndoFemoral Aimer
72201717	7.0 mm Offset EndoFemoral Aimer
7205521	2.0-5.0 mm Offset Guide
7205622	NOTCHMASTER <sup>®</sup> 8.0 mm Curette
7209214	Slotted sizing block
72201731	Sterilization Tray for ACUFEX Director ELITE ACL Drill Guide System

#### Optional Accessories

013522	6.0 mm Graft Sizing Tube
013523	7.0 mm Graft Sizing Tube
013524	8.0 mm Graft Sizing Tube
013525	9.0 mm Graft Sizing Tube
013526	10 mm Graft Sizing Tube
013527	11 mm Graft Sizing Tube
013528	12 mm Graft Sizing Tube
72201735	5-6 mm bone tunnel plug
72201733	5 mm half-round rasp
72201734	6 mm half-round rasp
72201883	Chondral pick, small, 20°
72201884	Chondral pick, large, 20°
72201885	Chondral pick, small, 40°
72201886	Chondral pick, large, 40°
72201786	Chondral pick, small, 90°



## ACL/PCL Reconstruction Drill Guide Systems

### ACUFEX DIRECTOR® ACL System Sets

#### ACUFEX® DIRECTOR ELITE Soft Tissue Drill Guide System



The Smith & Nephew ACUFEX DIRECTOR **ELITE Soft Tissue** Drill Guide System is a complete system of instruments for the accurate, reproducible placement and drilling of tibial and femoral tunnels during single-incision ACL reconstruction. The system components are sized for soft tissue grafts using single- or double-tunnel techniques.

REF	Description	REF	Description
72201965	ACUFEX DIRECTOR ELITE Soft Tissue Drill Guide System		
System includes:			
7205517	ACUFEX DIRECTOR Drill Guide Requires: 1 Aimer and 1 Bullet (not included, see pg. H-39 and H-40)	013498	5.0 mm Endoscopic Drill
	7205518 ACUFEX DIRECTOR ACL Elbow Aimer	7207482	5.5 mm Endoscopic Drill
	7205519 ACUFEX DIRECTOR ACL Tip Aimer	013499	6.0 mm Endoscopic Drill
	7205524 ACUFEX DIRECTOR Angled Bullet	7207492	6.5 mm Endoscopic Drill
	7205525 ACUFEX DIRECTOR 4-Point Bullet	013660	7.0 mm Endoscopic Drill
		7207493	7.5 mm Endoscopic Drill
013498	5.0 mm Cannulated Drill	013661	8.0 mm Endoscopic Drill
7207491	5.5 mm Cannulated Drill	7207494	8.5 mm Endoscopic Drill
013542	6.0 mm Cannulated Drill	013662	9.0 mm Endoscopic Drill
7207483	6.5 mm Cannulated Drill	72201732	Universal EndoFemoral Aimer
013543	7.0 mm Cannulated Drill	72201737	EndoFemoral Aimer, no Offset
7207484	7.5 mm Cannulated Drill	72201713	3.0 mm Offset EndoFemoral Aimer
013544	8.0 mm Cannulated Drill	72071714	4.0 mm Offset EndoFemoral Aimer
7207485	8.5 mm Cannulated Drill	72071715	5.0 mm Offset EndoFemoral Aimer
013545	9.0 mm Cannulated Drill	7205521	2.0-5.0 mm Offset Guide
		7205622	NOTCHMASTER® 8.0 mm Curette
		7209214	Slotted sizing block
		72201731	Sterilization Tray for ACUFEX Director ELITE ACL Drill Guide System

## ACL/PCL Reconstruction Drill Guide Systems

### ACUFEX<sup>®</sup> DIRECTOR ACL System Sets

#### ACUFEX DIRECTOR ELITE<sup>®</sup> RCI Drill Guide System



The Smith & Nephew ACUFEX DIRECTOR ELITE RCI Drill Guide System is a complete system of instruments for the accurate, reproducible placement and drilling of tibial and femoral tunnels during ACL reconstruction using the RCI technique. The routers are specifically designed to compress the drilled bone into the tunnel walls, creating a firm fixation environment.

REF	Description	REF	Description
72201966	ACUFEX DIRECTOR ELITE RCI Drill Guide System		
System includes:			
7205517	ACUFEX DIRECTOR Drill Guide Requires: 1 Aimer and 1 Bullet (not included, see pg. H-39 and H-40) 7205518 ACUFEX DIRECTOR ACL Elbow Aimer 7205519 ACUFEX DIRECTOR ACL Tip Aimer 7205524 ACUFEX DIRECTOR Angled Bullet 7205525 ACUFEX DIRECTOR 4-Point Bullet	72201732	Universal EndoFemoral Aimer
		72201737	EndoFemoral Aimer, no Offset
		72201713	3.0 mm Offset EndoFemoral Aimer
		72201714	4.0 mm Offset EndoFemoral Aimer
		72201715	5.0 mm Offset EndoFemoral Aimer
		7205521	2.0-5.0 mm Offset Guide
7207167	6.5 mm RCI Tibial Stepped Router	7205622	NOTCHMASTER <sup>®</sup> 8.0 mm Curette
7207168	7.0 mm RCI Tibial Stepped Router	7209214	Slotted sizing block
7207171	7.5 mm RCI Tibial Stepped Router	72201731	Sterilization Tray for ACUFEX Director ELITE ACL Drill Guide System
7207172	8.0 mm RCI Tibial Stepped Router		
7207173	8.5 mm RCI Tibial Stepped Router		
7207174	6.5 mm RCI Femoral Stepped Router		
7207175	7.0 mm RCI Femoral Stepped Router		
7207176	7.5 mm RCI Femoral Stepped Router		
7207177	8.0 mm RCI Femoral Stepped Router		
7207178	8.5 mm RCI Femoral Stepped Router		

## ACL/PCL Reconstruction Drill Guide Systems

### ACUFEX DIRECTOR ACL System Sets

#### ACUFEX® DIRECTOR ELITE Bone-Tendon-Bone ACL Drill Guide System



The Smith & Nephew ACUFEX DIRECTOR ELITE Bone-Tendon-Bone Drill Guide System is a complete system of instruments for the accurate, reproducible placement and drilling of tibial and femoral tunnels during ACL reconstruction. The system components are sized for the use of bone-tendon-bone grafts.

REF	Description	REF	Description
72201967	ACUFEX DIRECTOR ELITE Bone-Tendon-Bone Drill Guide System		
System includes:			
7205517	ACUFEX DIRECTOR Drill Guide Requires: 1 Aimer and 1 Bullet (not included, see pg. H-39 and H-40)	72201732	Universal EndoFemoral Aimer
7205518	ACUFEX DIRECTOR ACL Elbow Aimer	72201715	5.0 mm Offset EndoFemoral Aimer
7205519	ACUFEX DIRECTOR ACL Tip Aimer	72201716	6.0 mm Offset EndoFemoral Aimer
7205524	ACUFEX DIRECTOR Angled Bullet	72201717	7.0 mm Offset EndoFemoral Aimer
7205525	ACUFEX DIRECTOR 4-Point Bullet	7205521	2.0-5.0 mm Offset Guide
013544	8.0 mm Cannulated Drill	7205622	NOTCHMASTER® 8.0 mm Curette
7207485	8.5 mm Cannulated Drill	7209214	Slotted sizing block
013545	9.0 mm Cannulated Drill	72201731	Sterilization Tray for ACUFEX Director ELEITE ACL Drill Guide System
013546	10 mm Cannulated Drill		
013547	11 mm Cannulated Drill		
013548	12 mm Cannulated Drill		
013661	8.0 mm Endoscopic Drill		
7207494	8.5 mm Endoscopic Drill		
013662	9.0 mm Endoscopic Drill		
013663	10 mm Endoscopic Drill		
013664	11 mm Endoscopic Drill		
013665	12 mm Endoscopic Drill		

## ACL/PCL Reconstruction Drill Guide Systems

### ACUFEX DIRECTOR ACL System Sets

#### ACUFEX® DIRECTOR ELITE Rear Entry Drill Guide System



The Smith & Nephew ACUFEX DIRECTOR ELITE Rear Entry Drill Guide System is a complete system of instruments for the accurate, reproducible placement and drilling of tibial and femoral tunnels during ACL reconstruction. The system components are designed for a two-incision technique.

REF	Description	REF	Description
72201968	ACUFEX DIRECTOR ELITE Rear Entry Drill Guide System		
System includes:			
7205517	ACUFEX DIRECTOR Drill Guide Requires: 1 Aimer and 1 Bullet (not included, see pg. H-39 and H-40)	7207485	8.5 mm Cannulated Drill
	7205518 ACUFEX DIRECTOR ACL Elbow Aimer	013545	9.0 mm Cannulated Drill
	7205519 ACUFEX DIRECTOR ACL Tip Aimer	013546	10 mm Cannulated Drill
	7205524 ACUFEX DIRECTOR Angled Bullet	013547	11 mm Cannulated Drill
	7205525 ACUFEX DIRECTOR 4-Point Bullet	013548	12 mm Cannulated Drill
		7205521	2.0-5.0 mm Offset Guide
013644	Rear Entry Introducer	7205622	NOTCHMASTER® 8.0 mm Curette
013643	Rear Entry Aimer, left (includes Tri-Point Bullet REF 013645)	7209214	Slotted sizing block
013642	Rear Entry Aimer, right (includes Tri-Point Bullet REF 013645)	72201731	Sterilization Tray for ACUFEX Director ELITE ACL Drill Guide System
013498	5.0 mm Cannulated Drill		
72077491	5.5 mm Cannulated Drill	Optional:	
013542	6.0 mm Cannulated Drill	014723†	7.9 mm GORE SMOOTHER® Crucial Tool, sterile (optional)
7207483	6.5 mm Cannulated Drill		
013543	7.0 mm Cannulated Drill	014724†	9.5 mm GORE SMOOTHER Crucial Tool, sterile (optional)
7207484	7.5 mm Cannulated Drill		
013544	8.0 mm Cannulated Drill		

†Removes operative debris and leads graft into tunnels

## ACL/PCL Reconstruction Drill Guide Systems

### ACL Revision REDUX System

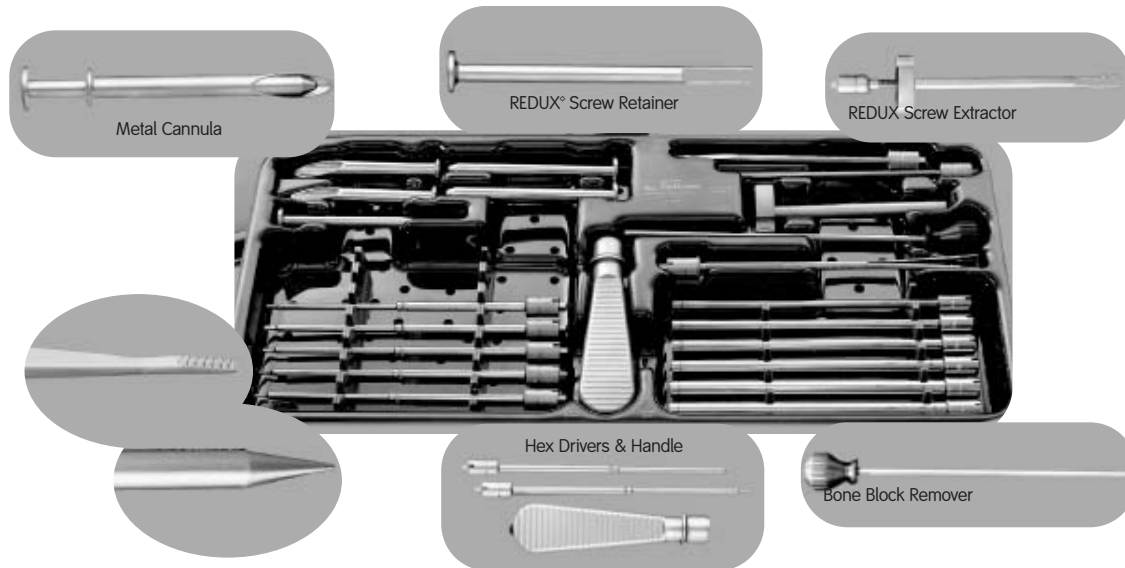

ACL REDUX System facilitates the removal of most leading manufacturers' interference screws from the knee during ACL revision surgery. The instrumentation addresses a wide variety of fixation techniques as well as the range of manufacturers' differences in screwdriver interface sizes.

REF	Description		
014696	ACL REDUX System		
System includes:		Included Disposables:	
014621	REDUX Bone Pick	014421	7.0 mm Trepine Drill
014620	REDUX Rasp Pick	014422	8.0 mm Trepine Drill
014626	REDUX Screw Retainer	014423	9.0 mm Trepine Drill
014528	Universal Driver Handle	014424	10 mm Trepine Drill
014766	REDUX 1.9 mm Driver		
014767	REDUX 2.3 mm Driver	Optional:	
014768	REDUX 2.4 mm Driver	014432	Bone Block Remover
014769	REDUX 2.7 mm Driver		
014770	REDUX 3.4 mm Driver	Optional Disposables:	
014598	REDUX 9.0 mm Metal Cannula	014425	11 mm Trepine Drill
014599	REDUX 9.0 mm Obturator	014426	12 mm Trepine Drill
014624	REDUX 10 mm Metal Cannula		
014639	REDUX 10 mm Obturator		
014627	REDUX Screw Extractor		
014870	Sterilization Tray for ACL REDUX System		



## ACL/PCL Reconstruction Drill Guide Systems

### ACL Revision REDUX System

#### Interference Screws – REDUX Cross Reference Index

	Interference Screw	Screw Hex Size	Driver Tip Size	Corresponding REDUX Driver
ACUFEX <sup>®</sup>	Interference 5.5 mm	2.0 mm	1.9 mm	014766
	Interference 7.0 mm	2.4 mm	2.3 mm	014767
	CANNU-FLEX <sup>®</sup> 7.0 mm	2.4 mm	2.3 mm	014767
	CANNU-FLEX SILK <sup>®</sup> 1.0, 6.0-8.0 mm	2.8 mm	2.7 mm	014769
	CANNU-FLEX SILK 1.0, 9.0 mm	3.5 mm	3.4 mm	014770
	CANNU-FLEX SILK 1.5	3.5 mm	3.4 mm	014770
	Interference 9.0 mm	3.5 mm	3.4 mm	014770
	CANNU-FLEX 9.0 mm	3.5 mm	3.4 mm	014770
	SOFTSILK <sup>®</sup> 1.5 and 2.0	3.5 mm	3.4 mm	014770
	RCI	3.5 mm	3.4 mm	014770
Arthrex <sup>®</sup>	6.0 mm	2.5 mm	2.4 mm	014768
	7.0 mm, 8.0 mm, and 9.0 mm	3.5 mm	3.4 mm	014770
DePuy <sup>®</sup>	5.5 mm	2.0 mm	1.9 mm	014766
	7.0 mm	2.5 mm	2.4 mm	014768
	9.0 mm	3.5 mm	3.4 mm	014770
DYONICS <sup>®</sup>	SOFTLOC <sup>®</sup>	3.5 mm	3.4 mm	014770
	Self-Guided Cannulated Screw	3.5 mm	3.4 mm	014770
	5.0 mm-6.0 mm	2.5 mm	2.4 mm	014768
	7.0 mm-9.0 mm	3.5 mm	3.4 mm	014770
Linvatec <sup>®</sup>	5.75 mm	2.5 mm	2.4 mm	014768
	7.0 mm and 9.0 mm	3.5 mm	3.4 mm	014770

## ACL/PCL Reconstruction Drill Guide Systems

### TRE-CORE<sup>®</sup> Trepine System

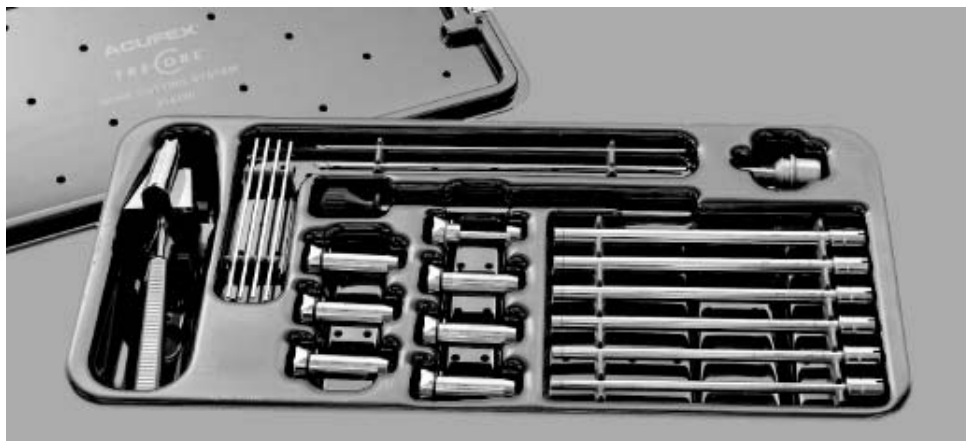

Used in conjunction with ACL Guide Systems for bone tunnel coring and bone core harvesting.

The TRE-CORE Trepine Drill Guide System is an accurate drilling system that cores a bone tunnel during cruciate reconstruction, leaving a diameter-specific cancellous bone plug to fill defects from patellar, tibial, and femoral harvest sites.

REF	Description		
014420	TRE-CORE Trepine Drill Guide System		
System includes:		<b>Disposables, single-use, non-sterile:</b>	
014430	TRE-CORE Guide	014510	2.7 mm Locking Pins, package of 6
014431	Quick Release Adaptor	013978	2.4 mm Drill-Tip Guide Wires, package of 6
014432	Bone Block Remover		
014439	2.4 mm Trepine Bullet	014421	7.0 mm Trepine Drill
014433	7.0 mm Trepine Bullet	014422	8.0 mm Trepine Drill
014434	8.0 mm Trepine Bullet	014423	9.0 mm Trepine Drill
014435	9.0 mm Trepine Bullet	014424	10 mm Trepine Drill
014436	10 mm Trepine Bullet	014425	11 mm Trepine Drill
014437	11 mm Trepine Bullet	014426	12 mm Trepine Drill
014438	12 mm Trepine Bullet		
011802	Sterilization Tray for TRE-CORE Trepine Drill Guide System		

#### Trepine Drills

Used with TRE-CORE<sup>®</sup> (REF 014420) and REDUX<sup>®</sup> (REF 014696) Systems, 7" (17.75 cm) length, single use only.

	014421	7.0 mm O.D. x 6.0 mm I.D.
	014422	8.0 mm O.D. x 7.0 mm I.D.
	014423	9.0 mm O.D. x 8.0 mm I.D.
	014424	10 mm O.D. x 9.0 mm I.D.
	014425	11 mm O.D. x 10 mm I.D.
	014426	12 mm O.D. x 11 mm I.D.

## ACL/PCL Reconstruction Drill Guide Systems

### TUNDRA<sup>®</sup> PCL Aimer System



REF	Description	REF	Description
7210822	TUNDRA PCL Aimer System		
System includes:			
7210605	PCL Aimer Arm	7210634	7.0 mm Bullet Sleeve for 2.4 mm Guide Wire
7210606	Aimer Base Assembly	7210635	8.0 mm Bullet Sleeve for 2.4 mm Guide Wire
7210607	Outriggers	7210636	9.0 mm Bullet Sleeve for 2.4 mm Guide Wire
7210608	10 mm concentric PCL Bullet Assembly	7210637	10 mm Bullet Sleeve for 2.4 mm Guide Wire
7210609	11 mm concentric PCL Bullet Assembly	7210638	11 mm Bullet Sleeve for 2.4 mm Guide Wire
7210610	12 mm concentric PCL Bullet Assembly	7210639	12 mm Bullet Sleeve for 2.4 mm Guide Wire
7210617	7.0-8.0 mm Plunger		
7210618	9.0-10 mm Plunger	Disposables required:	
7210619	11-12 mm Plunger	7210620	7.0 mm Trepine Drill, sterile
7210626	7.0 mm Trepine Adaptor	7210621	8.0 mm Trepine Drill, sterile
7210627	8.0 mm Trepine Adaptor	7210622	9.0 mm Trepine Drill, sterile
7210628	9.0 mm Trepine Adaptor	7210623	10 mm Trepine Drill, sterile
7210629	10 mm Trepine Adaptor	7210624	11 mm Trepine Drill, sterile
7210630	11 mm Trepine Adaptor	7210625	12 mm Trepine Drill, sterile
7210631	12 mm Trepine Adaptor		
7210633	Sterilization Tray		



## ACL/PCL Reconstruction Drill Guide Systems

### ACUFEX<sup>®</sup> Director PCL System

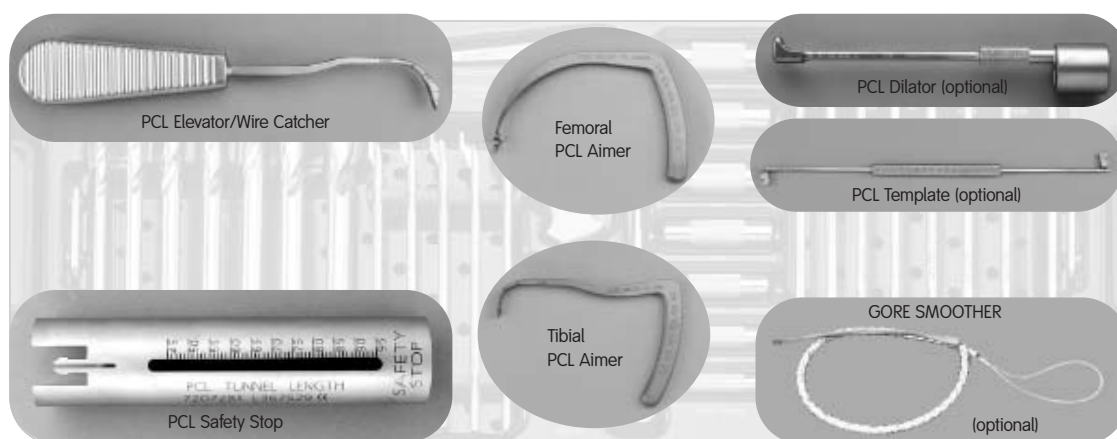

The Smith & Nephew ACUFEX Director PCL components are designed as an integral part of the ACUFEX Director Drill Guide System, providing tools that enable easy, accurate, and reproducible PCL reconstruction. For enhanced patient safety, this system includes the ACUFEX Director PCL Safety Stop, which easily snaps onto the ACUFEX Director Guide Handle and provides a positive drill stop when used with the Safety Guide Wire. Use of these components requires the ACUFEX Director ACL system.

REF	Description	REF	Description
7207223	ACUFEX Director PCL Drill Guide System		
System Includes:			
7207282	ACUFEX Director PCL Tibial Aimer	013671	PCL Tibial Curette, closed
7207283	ACUFEX Director PCL Femoral Aimer	013672	PCL Tibial Hook Knife
7207281	ACUFEX Director PCL Safety Stop	013673	PCL Tibial Curette, open
7207285	PCL Elevator with Wire Catcher	013674	PCL Femoral Curette, calibrated
Requires one of the following ACL Drill Guide Systems (not included):			
All of the following systems require an Angled Bullet for tibia and a 4-Point Bullet for femur.			
72201746	ACUFEX Director ELITE ACL Drill Guide System	013629	PCL Screwdriver
72201965	ACUFEX Director ELITE Soft Tissue Drill Guide System	013622	PCL 8.0 mm Drill Stop
72201967	ACUFEX Director ELITE Bone-Tendon-Bone Drill Guide System	013623	PCL 9.0 mm Drill Stop
72201966	ACUFEX Director ELITE RCI Drill Guide System	013624	PCL 10 mm Drill Stop
72201968	ACUFEX Director ELITE Rear Entry Drill Guide System	013625	PCL 11 mm Drill Stop
Optional Components:			
7207291	PCL Twin Tunnel Template	7207357	Large Generic Sterilization Tray
7207292	Oval Sizing Tube/Dilator	<b>Disposables required:</b>	
013670	PCL Tibial Rasp	7207284	PCL Safety Guide Wire (required) Calibrated guide wire used in conjunction with the ACUFEX Director PCL Safety Stop to indicate when the tip of the wire has penetrated the posterior cortex.
		Optional:	
		014723*	7.9 mm GORE SMOOTHER <sup>®</sup> Crucial Tool <sup>†</sup> , sterile (optional)
		014724	9.5 mm GORE SMOOTHER Crucial Tool <sup>†</sup> , sterile (optional)

\* For two-incision techniques only

†Removes operative debris and leads graft into tunnels

## ACL/PCL Drill Guide System Components & Accessories

### ACUFEX<sup>®</sup> Director System Set Components

#### Smith & Nephew ACUFEX Director Drill Guide

Requires ACUFEX Director Aimer and ACUFEX Director Bullet, not included.



REF	Description
7205517	ACUFEX Director Drill Guide The most rigid, accurate guide designed for easy, single-handed placement.

#### Smith & Nephew ACUFEX Director Aimers



7205518	ACUFEX Director ACL <b>Elbow</b> Aimer For drilling to the laser mark at the aimer's elbow; useful when the ACL stump is not removed from the tibia.
---------	---



7205519	ACUFEX Director ACL <b>Tip</b> Aimer For drilling to the tip of the aimer; useful when the ACL stump is completely removed from the tibia.
---------	---



7207282	ACUFEX Director PCL <b>Tibial</b> Aimer Rigid design along with calibrated tip results in consistent, accurate guide wire placement; broad face of tip easily passes through notch and provides a means of protecting posterior capsule during guide wire drilling.
---------	--





7207283	ACUFEX Director PCL <b>Femoral</b> Aimer For outside-in drilling with medial incision. Rigid design along with calibrated tip results in consistent, accurate guidewire placement; hoop tip provides a visual reference for the diameter of the fully reamed tunnel, helping avoid tunnel encroachment on the articular surface.
---------	---

## ACL/PCL Drill Guide System Components & Accessories

### ACUFEX<sup>®</sup> Director System Set Components

#### Smith & Nephew ACUFEX Director Bullets

	REF	Description
	7205524	ACUFEX Director Angled Bullet, 2.4 mm I.D. Tip angle matches the engagement angle of the ACUFEX Director Guide on the tibia for secure placement.
	7205525	ACUFEX Director 4-Point Bullet, 2.4 mm I.D. Four sharp points for secure engagement of the ACUFEX Director Guide at any angle.

#### Made to Order – Aimers and Cruciate Accessory Pacs

**NOTE:** Made to Order products have longer production times. Please contact your sales representative or customer service for more information.

REF	Description
7205603	Aimer, Tibial Spine Referencing (TSR), Director
013502	Handle ACL (use with blue handle Aimer)

## ACL/PCL Drill Guide System Components & Accessories

### Offset Guides and Aimers

#### Anti-Impingement Device

Allows the surgeon to check for impingement *before* drilling the tibial tunnel. The reusable device snaps on the tibial guide wire and verifies adequate notch clearance as the knee is extended.



REF	Description
7205587	5.0 mm, used with 9.0 mm and 10 mm grafts
7205588	4.0 mm, used with 7.0 mm and 8.0 mm grafts

#### Endoscopic Femoral Guide System

Easily and effectively determines femoral guide wire placement by referencing the over-the-top position through the tibial tunnel. Straight or offset positions to work in-line or at 60° angle. Color coded for guide identification of size.



REF	Description
72201732	Universal EndoFemoral Aimer
72201737	EndoFemoral Aimer, no Offset
72201713	Endoscopic Femoral Aimer Arm, 3.0 mm offset
72201714	Endoscopic Femoral Aimer Arm, 4.0 mm offset
72201715	Endoscopic Femoral Aimer Arm, 5.0 mm offset
72201716	Endoscopic Femoral Aimer Arm, 6.0 mm offset
72201717	Endoscopic Femoral Aimer Arm, 7.0 mm offset
Optional:	
7207694	Inline Endoscopic Femoral Guide Handle (cannulated)
014800	Non-cannulated handle

#### Made to Order – Endoscopic Femoral Aimers

**NOTE:** Made to Order products have longer production times. Please contact your sales representative or customer service for more information.

REF	Description
3134213	Aimer, EndoFemoral (no offset)
3134250	Aimer, EndoFemoral 7.0 mm offset, 2.7 mm I.D., with rounded prongs and Hudson Adaptor
3134251	Aimer, EndoFemoral 6.0 mm offset, 2.7 mm I.D., with rounded prongs and Hudson Adaptor
3134252	Aimer, EndoFemoral 5.0 mm offset, 2.7 mm I.D., with rounded prongs and Hudson Adaptor

#### Offset Drill Guides

Assists in repositioning guide wire from primary guide wire location.



REF	Description
7205521	2.0–5.0 mm Offset Guide Unique design utilizes an integral guide pin to provide offsets as low as 2 mm







REF	Description
7205522	3.0–9.0 mm Offset Guide 1 mm increments allow precise repositioning of guide wires; 9 mm maximum offset aids in placement of parallel wires for twin tunnel techniques

## ACL/PCL Drill Guide System Components & Accessories



### Rear Entry Components

#### Rear Entry Femoral Aimers

	REF	Description
	013642	Rear Entry Aimer, right, shown with Tri-Point Bullet, included
	013643	Rear Entry Aimer, left, shown with Tri-Point Bullet, included
	013644	Rear Entry Introducer
	013645	Tri-Point Bullet Used with Rear Entry Aimers (REF 013642 and 013643) and Puddu Aimers (REF 013696 and 013597)

#### GORE SMOOTHER® Crucial Tools

Removes operative debris and leads graft into tunnels.

	014723*	7.9 mm, sterile
	014724	9.5 mm, sterile
	013646	2.4 mm Tri-Point K-Wire Sleeve Used with ACL handle (REF 013502 pg. H-63)

## ACL/PCL Drill Guide System Components & Accessories

### MULTI-TRAC<sup>®</sup> Components

Made to Order products have longer production times. Please contact your sales representative or customer service for more information.

#### MULTI-TRAC Bullets

Used with MULTI-TRAC Drill Guide (REF 014523).

REF	Description
013497Z	MULTI-TRAC Tri-Point Bullet, 2.4 mm I.D., recommended for ACL reconstruction

#### MULTI-TRAC ACL Aimers

Used with MULTI-TRAC Drill Guide (REF 014523).

014520Z	MULTI-TRAC ACL Tibial Aimer Tip Drills, to tip of aimer
014521Z	MULTI-TRAC ACL Tibial Aimer Impingement, used to check for roof impingement
014522Z	MULTI-TRAC ACL Tibial Aimer Elbow Drills, to elbow of aimer

#### MULTI-TRAC PCL Aimers

Used with MULTI-TRAC Drill Guide (REF 014523).

014654Z	MULTI-TRAC PCL Femoral Aimer
014673Z	MULTI-TRAC PCL Tibial Aimer

## ACL/PCL Drill Guide System Components & Accessories

### Drill Bits, Routers & Bone Graft Compressors

#### Cannulated Drill Bits

Used with ACL and PCL Drill Guide Systems, 2.4 mm I.D., 7" (17.75 cm) length.



REF	Description	REF	Description
013498	5.0 mm	013546	10 mm
7207491	5.5 mm	7207487	10.5 mm
013542	6.0 mm	013547	11 mm
7207483	6.5 mm	7207488	11.5 mm
013543	7.0 mm	013548*	12 mm
7207484	7.5 mm	7207489	12.5 mm
013544	8.0 mm	013549	13 mm
7207485	8.5 mm	7207490	13.5 mm
013545	9.0 mm	013551	14 mm
7207486	9.5 mm		

#### Endoscopic Cannulated Drill Bits

Used with Endoscopic ACL Drill Guide Systems for Femoral Tunnel Drilling, 2.4 mm I.D., 7" (17.75 cm) length, calibrated.

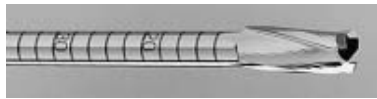

REF	Description
7207315	4.5 mm (use with ENDOBUTTON®, ENDOBUTTON CL, or RCI screws), sterile, disposable, single use
013184*	4.5 mm (use with ENDOBUTTON, ENDOBUTTON CL, or RCI screws), non-sterile, disposable, single use



REF	Description	REF	Description
7208686	5.0 mm	013663*	10 mm
7207482	5.5 mm	7207496	10.5 mm
013499	6.0 mm	013664	11 mm
7207492	6.5 mm	7207497	11.5 mm
013660	7.0 mm	013665	12 mm
7207493	7.5 mm	7207498	12.5 mm
013661	8.0 mm	013666	13 mm
7207494	8.5 mm		
013662	9.0 mm		
7207495	9.5 mm		

#### Non-Cannulated Drill Bit

REF	Description
6900854	4.5 mm, non-cannulated

\* Item shown

## ACL/PCL Drill Guide System Components & Accessories

### Drill Bits, Routers & Bone Graft Compressors

#### Drill Bits Single Flute – Endoscopic Cannulated



REF	Description	REF	Description
3134179	5.5 mm	3134188	10 mm
3134180	6.0 mm	3134189	10.5 mm
3134181	6.5 mm	3134190	11.0 mm
3134182	7.0 mm	3134191	11.5 mm
3134183	7.5 mm	3134192	12 mm
3134184	8.0 mm	3134193	12.5 mm
3134185	8.5 mm	3134194	13.0 mm
3134186	9.0 mm		
3134187	9.5 mm		

#### Drill Bit for DonJoy RCI Tibial Guide

6900854      4.5 mm non-cannulated drill bit

#### RCI Stepped Routers

Patented design compacts the drilled bone into the tunnel wall for improved graft fixation. Wings at the proximal end of the cutting head chamfer the tunnel entrance to minimize stress risers and accommodate the RCI Screw.

	REF	Description
	RCI Tibial Stepped Routers	
	7207167	6.5 mm
	7207168	7.0 mm
	7207171	7.5 mm
	7207172	8.0 mm
	7207173*	8.5 mm
	RCI Femoral Stepped Routers	
	7207174	6.5 mm
	7207175	7.0 mm
	7207176	7.5 mm
	7207177	8.0 mm
	7207178*	8.5 mm

\* Item shown



## ACL/PCL Drill Guide System Components & Accessories

### Drill Bits, Routers & Bone Graft Compressors Drill Bits

Made to Order products have longer production times. Please contact your sales representative or customer service for more information.

#### Routers – Wingless RCI Routers

With laser markings 5 mm to 120 mm in 5 mm increments.

REF	Description
7207761	Router, Femoral 6.5 mm Wingless
7207762	Router, Femoral 7.0 mm Wingless
7207763	Router, Femoral 7.5 mm Wingless
7207764	Router, Femoral 8.0 mm Wingless
7207765	Router, Femoral 8.5 mm Wingless
7207766	Router, Femoral 9.0 mm Wingless
7207767	Router, Femoral 9.5 mm Wingless
7207768	Router, Femoral 10.0 mm Wingless
7207769	Router, Femoral 10.5 mm Wingless
7207770	Router, Femoral 11.0 mm Wingless

#### Routers – RCI Routers

With laser markings 30 mm to 80 mm in 10 mm increments.

3134273	Router, Femoral 6.5 mm
3134274	Router, Femoral 7.0 mm
3134275	Router, Femoral 7.5 mm
3134276	Router, Femoral 8.0 mm
3134277	Router, Femoral 8.5 mm

#### Pins and Wires (non-sterile)

3134221	Blunt Tip Passing Pin, 2.4 mm x 17" (43 cm), package of 1
3134284	Blunt Tip Passing Pin, 2.4 mm x 17" (43 cm), with notched eyelet, package of 1
7207703	Drill Tip Guide Wire, 2.4 mm x 12" (30 cm), package of 6
7207776	Trocar-Tip Screw Guide Wire, 1.0 mm x 12" (30 cm), package of 6

#### Bone Graft Compressors

7209281	9.0 mm Bone Graft Compressor, with 2.5 mm hole and 1.0 mm slot
7209282	10 mm Bone Graft Compressor, with 2.5 mm hole and 1.0 mm slot
7209283	11 mm Bone Graft Compressor, with 2.5 mm hole and 1.0 mm slot

## ACL/PCL Drill Guide System Components & Accessories

### Sizing Tubes, Dilators, and Blocks

#### Graft Sizing Tubes

Used with ACL and PCL Drill Guide Systems to size the graft for precise graft tunnel interface.

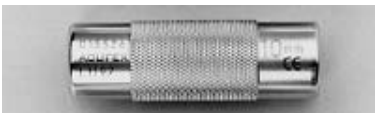
	REF	Description	REF	Description
	7207499	5.0 mm	013526*	10 mm
	7207500	5.5 mm	7207502	10.5 mm
	013522	6.0 mm	013527	11 mm
	7207163	6.5 mm	7207503	11.5 mm
	013523	7.0 mm	013528	12 mm
	7207164	7.5 mm	7207504	12.5 mm
	013524	8.0 mm	013529	13 mm
	7207165	8.5 mm	7207505	13.5 mm
	013525	9.0 mm	013540	14 mm
	7207501	9.5 mm		

#### Dilators

Expands bone tunnels by compacting cancellous bone in the tibial and femoral tunnel walls. Tray holds 1/2 mm size drill bits, making it a comprehensive soft tissue graft accessory system.

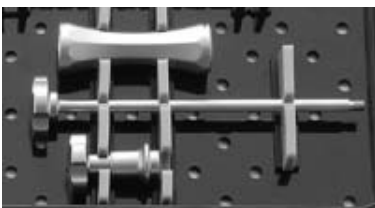
	REF	Description	7207878 Comprehensive System	7209066 Basic System
	7207640	6.0 mm	•	
	7207641	6.5 mm	•	
	7207642	7.0 mm	•	
	7207643	7.5 mm	•	•
	7207644	8.0 mm	•	•
	7207645	8.5 mm	•	•
	7207646	9.0 mm	•	•
	7207647	9.5 mm	•	•
	7207648	10 mm	•	
	7207649	11 mm	•	
	7207650*	12 mm	•	
	7207638*	Sizing Block	•	•
	7209214	Slotted Sizing Block		
	7207639*	Slaphammer Minimizes the potential for creating oval-shaped tunnels when using T-handle -style dilators	•	•
	7207637	Tray	•	•

#### Made to Order Accessories

Made to Order products have longer production times. Please contact your sales representative or customer service for more information.

6900876 T-Handle to remove dilators (sold separate from the system)

• - Included in system







\* Item shown

Call +1-800-343-5717 (U.S.) or contact your local representative.

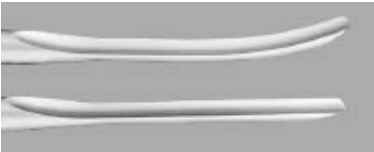
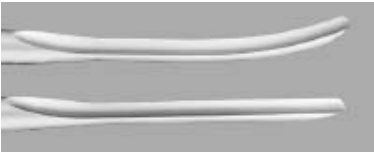
# ACL/PCL Drill Guide System Components & Accessories

## ACL Arthroplasty Instruments

### NOTCHMASTER® Instruments



	REF	Description
	7205622	NOTCHMASTER 8.0 mm angled curette Designed specifically to facilitate the removal of soft tissue and bone from the notch during notchplasty
	012724	6.4 mm NOTCHMASTER, curved gouge
	012722	6.4 mm NOTCHMASTER, straight gouge
<b>Osteotome</b>		
	012701	Straight
<b>Gouge</b>		
	012702	Compound curved
<b>Curettes</b>		
	012704	4.0 mm, open
	012717	7.0 mm, open
	012703*	3.0 mm, closed
	012710	5.0 mm, closed

\* Item shown







## ACL/PCL Drill Guide System Components & Accessories

### ACL Arthroplasty Instruments

#### Rasps

	REF	Description
	012705	Convex
	012708	Compound Curve

#### ACL Chamfering Rasps

	013569	Bone Tunnel
	013570	Chamfering
	013571	8.0 mm, half-round
	013572	7.0 mm, half-round
	72201734	6.0 mm, half-round
	72201733	5.0 mm, half-round

## ACL/PCL Drill Guide System Components & Accessories

### PCL Arthroplasty Instruments

#### Elevator with Wire Catcher

Indispensable 3-in-1 PCL Accessory Instrument



REF	Description
7207285	Elevator with Wire Catcher

Sharp elevator tip elevates the PCL and periosteum from the bone when used in the fore/aft plane. Blunt elevator sides open the posterior compartment when used in a rotational motion. Wire capture hole secures the wire while reaming the tibial tunnel, protecting the neurovascular structures from the drill tip as it exits the posterior cortex.

REF	Description	REF	Description
013670	PCL Tibial Rasp	013672	PCL Tibial Hook Knife
013671	PCL Tibial Curette, closed	013673	PCL Tibial Curette, open
013674	PCL Femoral Curette, calibrated 10 mm from tip		

#### PCL Drill Stops

Drill Stops designed for use with ACUFEX® Cannulated Drills to limit the depth of drill penetration.



REF	Description	REF	Description
013620	6.0 mm	013625*	11 mm
013621	7.0 mm	013626	12 mm
013622*	8.0 mm	013627	13 mm
013623*	9.0 mm	013628	14 mm
013624*	10 mm	013629*	PCL Screwdriver





## ACL/PCL Drill Guide System Components & Accessories

### MCL MicroPerforation Instruments

MicroPerforation of the medial ligament complex reestablishes an acute healing environment for treatment of sub-acute and chronic MCL laxity. In conjunction with ACL reconstruction, MicroPerforation may stimulate medial complex healing to increase the probability of successful ACL outcome.

#### Made to Order

Made to Order products have longer production times. Please contact your sales representative or customer service for more information.

	REF	Description
	7205975	MicroPerforation Instrument, small concave
	7205976	MicroPerforation Instrument, small convex
	7205977	MicroPerforation Instrument, large concave
	7205978	MicroPerforation Instrument, large convex

### Bone Tunnel Plugs

#### Bone Tunnel Plugs – Cannulated

Single use, sterile

	REF	Description
	014477	Cannulated, fits 7.0-12.0 mm tunnels, latex-free, box of 6
	7210149	Cannulated, fits 7.0-12.0 mm tunnels, contains latex, box of 6

#### Bone Tunnel Plugs – Non-Cannulated

Made of polyacetal, non-sterile

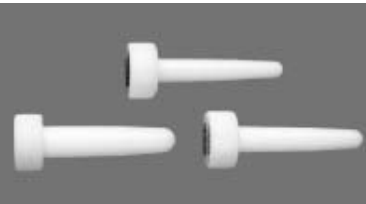

	013563	Set (3 small, 3 medium, 3 large)
	72201735	X-small, 5.0-6.0 mm, package of 3
	013560	Small, 7.0-8.0 mm, package of 3
	013561	Medium, 9.0-10 mm, package of 3
	013562	Large, 10-11 mm, package of 3
	013589	Set (3 large, 3 X-large, 3 XX-large)
	013587	X-large, 11-12 mm, package of 3
	013588	XX-large, 13-14 mm, package of 3
	013592	Comprehensive set (3 small, 3 medium, 3 large, 3 X-large, 3 XX-large)
	7207724	Blue silicon plug, reusable
	72201735	5-6 mm Bone tunnel plug

## ACL/PCL Drill Guide System Components & Accessories

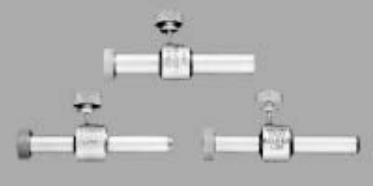

### Isometry

#### ISOTAC<sup>®</sup> System

For determining isometric femoral tunnel location in cruciate reconstruction.

	REF	Description
 <p>ISOTAC Tibial Guides</p>	013581	ISOTAC System
	System includes:	
	013580	Isometric Positioner
	013582	ISOTAC Driver
	013652	7.0-8.0 mm Adjustable ISOTAC Tibial Guide
 <p>Isometric Positioner</p>	013653	9.0-10 mm Adjustable ISOTAC Tibial Guide
	013654	11 mm+ Adjustable ISOTAC Tibial Guide
	011703	Small Sterilization Tray
 <p>ISOTAC Driver</p>	Single use:	
	013583	ISOTAC, sterile, disposable
	013593	Suture Retriever, sterile, disposable, box of 6
	014399	ISOTAC Pilot Wire, sterile, disposable

#### Isometry Disposables

	013583	ISOTAC, sterile, single use, box of 6 Requires #2 braided suture, not included
	014399*	ISOTAC Pilot Wire, 2.0 mm x 9" (23 cm) long, sterile, single use
	013619	ISOTAC Pilot Wire, 2.0 mm x 9" (23 cm) long, non-sterile, single use, package of 6

#### Suture Retriever

Used for passing or retrieving sutures through instrumentation with cannulations of 1.5 mm or larger; used in conjunction with Isometric Positioner, ISOTAC Driver, ENDOBUTTON<sup>®</sup>, and Passing Pins.

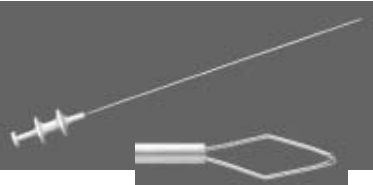
	013593	Suture Retriever, sterile, single use, box of 6
--	--------	---

## ACL/PCL Drill Guide System Components & Accessories

### Cruciate Pins and Wires

#### Drill-Tip Passing Pins

With eyelet for graft passage

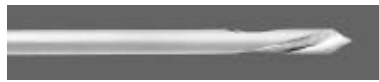

REF	Description
7211022	2.7 mm x 15" (38 cm) Graduated Drill-Tip Passing Pin, 2.7 mm diameter head 2.4 mm diameter shaft, non-sterile, single use, package of 6
014508*	2.7 mm x 15" (38 cm) Drill-Tip Passing Pin, 2.7 mm diameter head, 2.4 mm diameter shaft, sterile, single use, package of 6
014485	2.7 mm x 15" (38 cm) Drill-Tip Passing Pin, 2.7 mm diameter head, 2.4 mm diameter shaft, non-sterile, single use, package of 6
014604	2.4 mm x 15" (38 cm) Drill-Tip Passing Pin, non-sterile, single use, package of 6
7208678	2.4 mm x 15" (38 cm) Drill-Tip Passing Pin, sterile, single use
1107089	2.4 mm x 12" (30 cm) Beath Pin, two eyelets, sterile, single use, package of 3

#### Spade-Tip Passing Pin

With eyelet for graft passage



013110*	3.0 mm Spade-Tip Passing Pin, 2.4 mm diameter shaft x 11" (28 cm) long, non-sterile, single use, package of 6
013111	4.0 mm Spade-Tip Passing Pin, 2.4 mm diameter shaft x 11" (28 cm) long, non-sterile, single use, package of 6

#### Trocar-Tip Passing Pin

With eyelet for graft passage



014395	2.4 mm x 11" (28 cm) Trocar-Tip Passing Pin, sterile, single use, box of 1
7207220*	2.4 mm x 17" (43 cm) Trocar-Tip Passing Pin, sterile, single use, box of 1
013658	2.4 mm x 11" (28 cm) Trocar-Tip Passing Pin, non-sterile, single use, package of 6
7207702	2.4 mm x 17" (43 cm) Trocar-Tip Passing Pin, non-sterile, single use, package of 6

#### Cruciate Guide Wires

For use with ACUFEX® cruciate guides and cannulated drill bits



013978*	2.4 mm Drill-Tip Guide Wire, 10" (25 cm) long, no eyelet, non-sterile, single use, package of 6
014396	2.4 mm Drill-Tip Guide Wire, 10" (25 cm) long, no eyelet, sterile, single use, box of 1
7207221	2.4 mm Drill-Tip Guide Wire, 12" (30 cm) long, no eyelet, sterile, single use, box of 1
7208678	Drill-Tip Passing Pin, 2.4 mm x 15", sterile
7207284	PCL Safety Guide Wire, 2.4 mm x 10" (25 cm) long, no eyelet, sterile, single use, calibrated for use with the ACUFEX Director PCL Safety Stop, box of 1

\* Item shown



## ACL/PCL Drill Guide System Components & Accessories

### Cruciate Pins and Wires

#### Cruciate Pins and Wires

Guide wire for femoral tunnel, includes eyelet for passing pin

REF	Description	Quantity	Sterility	Systems
014395	Trocar-Tip Passing Pin, 2.4 mm x 11" (28 cm)	1	Sterile	ACUFEX <sup>®</sup> ACL & PCL Systems
013658	Trocar-Tip Passing Pin, 2.4 mm x 11" (28 cm)	6	Non-sterile	
7208678	Drill-Tip Passing Pin, 2.4 mm x 15" (38 cm)	1	Sterile	
014604	Drill-Tip Passing Pin, 2.4 mm x 15" (38 cm)	6	Non-sterile	
7207220	Trocar-Tip Passing Pin, 2.4 mm x 17" (43 cm)	1	Sterile	
014508	Drill-Tip Passing Pin, 2.7 mm x 15" (38 cm)	6	Sterile	
014485	Drill-Tip Passing Pin, 2.7 mm x 15" (38 cm)	6	Non-sterile	
013110	Spade-Tip Passing Pin, 3.0 mm x 11" (28 cm)	6	Non-sterile	
013111	Spade-Tip Passing Pin, 4.0 mm x 11" (28 cm)	6	Non-sterile	

#### Cruciate Pins and Wires

Guide wire for endo and cannulated drills, and all ACUFEX guides

014396	Drill-Tip Guide Wire, 2.4 mm x 10" (25 cm)	1	Sterile	ACUFEX ACL & PCL Systems
013978	Drill-Tip Guide Wire, 2.4 mm x 10" (25 cm)	6	Non-sterile	
7207221	Drill-Tip Guide Wire, 2.4 mm x 12" (30 cm)	1	Sterile	
7207284	PCL Safety Guide Wire, 2.4 mm x 10" (25 cm)	1	Sterile	

#### Cruciate Pins and Wires

Drills ISOTAC<sup>®</sup> pilot hole

014399	ISOTAC Pilot Wire	1	Sterile	ISOTAC
013619	ISOTAC Pilot Wire	6	Non-sterile	

#### Screw Guide Wires

Guide screw into a position parallel to bone block

014394	CANNU-FLEX <sup>®</sup> Screw Guide Wire, blunt, 1.0 mm x 12" (30 cm)	1	Sterile	CANNU-FLEX SILK <sup>®</sup> 1.0
014403	CANNU-FLEX Screw Guide Wire, blunt, 1.0 mm x 12" (30 cm)	6	Non-sterile	
013475	CANNU-FLEX Screw Guide Wire, trocar, 1.0 mm x 9" (23 cm)	6	Non-sterile	
014698	CANNU-FLEX Screw Guide Wire, blunt, 1.0 mm x 9" (23 cm)	6	Non-sterile	
014859	CANNU-FLEX Screw Guide Wire, 1.5 mm x 12" (30 cm)	1	Sterile	SOFTSILK <sup>®</sup> 1.5, SILK 1.5, BIORCI <sup>®</sup> , BIORCI-HA <sup>®</sup> , & ENDO-FIX <sup>®</sup>
014545	CANNU-FLEX Screw Guide Wire, 1.5 mm x 12" (30 cm)	6	Non-sterile	
7207636	CANNU-FLEX Screw Guide Wire, 1.5 mm x 9" (23 cm)	6	Non-sterile	
7207775	CANNU-FLEX Screw Guide Wire, 1.5 mm x 15" (38 cm)	6	Non-sterile	
7207160	CANNU-FLEX Screw Guide Wire, 2.0 mm x 9" (23 cm)	6	Non-sterile	SOFTSILK 2.0 & RCI
7205658	CANNU-FLEX Screw Guide Wire, 2.0 mm x 12" (30 cm)	6	Non-sterile	
7205659	CANNU-FLEX Screw Guide Wire, 2.0 mm x 12" (30 cm)	1	Sterile	
7207222	CANNU-FLEX Screw Guide Wire, 2.0 mm x 15" (38 cm)	1	Sterile	

## ACL/PCL Drill Guide System Components & Accessories

### Cruciate Accessory Pacs

#### RAP-PAC<sup>°</sup>

Comprehensive cruciate accessory pac for reconstruction when isometry is not selected. Sterile, single-use.

REF	Description
014725	RAP-PAC, latex-free
7210151	RAP-PAC, contains latex
RAP-PAC includes:	
013593	Suture Retriever
014396	2.4 mm x 10" Drill-Tip Guide Wire
014508	2.7 mm x 15" Drill-Tip Passing Pin
014394	CANNU-FLEX <sup>°</sup> Screw Guide Wire, 1.0 mm x 12"
014859	CANNU-FLEX Screw Guide Wire, 1.5 mm x 12"
7210118	7.0 mm CLEAR-TRAC <sup>°</sup> Screw Cannula, latex seal (included in REF 7210151 only)
7207227	7.0 mm CLEAR-TRAC Screw Cannula, latex-free seal (included in REF 014725 only)
014477	Cannulated Bone Tunnel Plug, latex-free (included in REF 014725 only)
7210149	Cannulated Bone Tunnel Plug, contains latex (included in REF 7210151 only)

#### RAP-PAC 1.5

Comprehensive cruciate accessory pac for reconstruction when isometry is not selected. Sterile, single-use.

7209217	RAP-PAC 1.5, latex-free
7210154	RAP-PAC 1.5, contains latex
RAP-PAC 1.5 includes:	
014396	2.4 mm x 10" Drill-Tip Guide Wire
014508	2.7 mm x 15" Drill-Tip Passing Pin
7207775	1.5 mm CANNU-FLEX Screw Guide Wire, 15"
014477	Cannulated Bone Tunnel Plug, latex-free (included in REF 7209217 only)
7210149	Cannulated Bone Tunnel Plug, contains latex (included in REF 7210154 only)

#### RAP-PAC 2.0

Comprehensive cruciate accessory pac for reconstruction when isometry is not selected. Sterile, single-use.

7209218	RAP-PAC 2.0, latex-free
7210155	RAP-PAC 2.0, contains latex
RAP-PAC 2.0 includes:	
014396	2.4 mm x 10" Drill-Tip Guide Wire
014508	2.7 mm x 15" Drill-Tip Passing Pin
7207222	2.0 mm CANNU-FLEX Screw Guide Wire, 15"
014477	Cannulated Bone Tunnel Plug, latex-free (included in REF 7209218 only)
7210149	Cannulated Bone Tunnel Plug, contains latex (included in REF 7210155 only)

## ACL/PCL Drill Guide System Components & Accessories

### Cruciate Accessory Pacs

#### Pin and Wire Pac A

REF	Description
7207738	Pin and Wire Pac A
Pac A includes:	
7207221	2.4 mm x 12" Drill-Tip Guide Wire
7207220	2.4 mm x 17" Passing Pin with Trocar Tip
014859	1.5 mm x 12" CANNU-FLEX® Screw Guide Wire

#### Pin and Wire Pac B

7207925	Pin and Wire Pac B
Pac B includes:	
7207221	2.4 mm x 12" Drill-Tip Guide Wire
7207220	2.4 mm x 17" Passing Pin with Trocar Tip
7207222	2.0 mm x 15" CANNU-FLEX Screw Guide Wire

#### Pin and Wire Pac C

7207926	Pin and Wire Pac C
Pac C includes:	
7207221	2.4 mm x 12" Drill-Tip Guide Wire
014508	2.7 mm x 15" Drill-Tip Passing Pin
014859	1.5 mm x 12" CANNU-FLEX Screw Guide Wire

#### Pin and Wire Pac D

7210156	Pin and Wire Pac D, contains latex (see pg. H-63 for latex-free Pac)
Pac D includes:	
7207221	2.4 mm x 12" Drill-Tip Guide Wire
014508	2.7 mm x 15" Drill-Tip Passing Pin
014859	1.5 mm x 12" CANNU-FLEX Screw Guide Wire
7210149	Cannulated Bone Tunnel Plug, contains latex

#### Pin and Wire Pac D – latex-free

7207940	Pin and Wire Pac D, latex-free
Pac D includes:	
7207221	2.4 mm x 12" Drill Tip Guide Wire
014508	2.7 mm x 15" Drill-Tip Passing Pin
014859	1.5 mm x 12" CANNU-FLEX Guide Wire
014477	Cannulated Bone Tunnel Plug, latex-free

#### Pin and Wire Pac E

7209203	Pin and Wire Pac E
Pac E includes:	
014396	2.4 mm x 10" Drill-Tip Guide Wire
014508	2.7 mm x 15" Drill-Tip Passing Pin
014394	1.0 mm x 12" CANNU-FLEX Screw Guide Wire (2)

## ACL/PCL Drill Guide System Components & Accessories

### Cruciate Accessory Pacs

#### Pin and Wire Pac F

REF	Description
7210157	Pin and Wire Pac F, contains latex (see pg. H-63 for latex-free Pac)
Pac F includes:	
7207221	2.4 mm x 12" Drill-Tip Guide Wire
7207220	2.4 mm x 17" Passing Pin with Trocar Tip
014859	1.5 mm x 12" CANNU-FLEX <sup>®</sup> Screw Guide Wire
7210149	Cannulated Bone Tunnel Plug, contains latex

#### Made to Order Pin and Wire Pac F – latex free

Made to Order products have longer production times. Please contact your sales representative or customer service for more information.

7209313	Pin and Wire Pac F, latex-free
Pac F includes:	
7207221	2.4 mm x 12" Drill Tip Guide Wire
7207220	2.4 mm x 17" Passing Pin with Trocar Tip
014859	1.5 mm x 12" CANNU-FLEX <sup>®</sup> Guide Wire
014477	Cannulated Bone Tunnel Plug, latex-free

#### ENDOBUTTON<sup>®</sup> CL Pac

Comprehensive cruciate accessory pac for reconstruction with ENDOBUTTON<sup>®</sup>. Sterile, single use.

7209216	ENDOBUTTON CL Pac, latex-free
7210153	ENDOBUTTON CL Pac, contains latex
ENDOBUTTON CL Pac includes:	
	ENDOBUTTON CL sizing chart
013184	Cannulated Endoscopic Drill, 4.5 mm
014396	2.4 mm x 10" Drill-Tip Guide Wire
014508	2.7 mm x 15" Drill-Tip Passing Pin
014477	Cannulated Bone Tunnel Plug, latex-free (included in REF 7209216 only)
7210149	Cannulated Bone Tunnel Plug, contains latex (included in REF 7210153 only)

#### ENDOBUTTON Pac

Comprehensive cruciate accessory pac for reconstruction with ENDOBUTTON. Sterile, single use.

014893	ENDOBUTTON Pac, latex-free
7210152	ENDOBUTTON Pac, contains latex
ENDOBUTTON Pac includes:	
013186	ENDOBUTTON
013184	Cannulated Endoscopic Drill, 4.5 mm
014396	2.4 mm x 10" Drill-Tip Guide Wire
014508	2.7 mm x 15" Drill-Tip Passing Pin
014477	Cannulated Bone Tunnel Plug, latex-free (included in REF 014893 only)
7210149	Cannulated Bone Tunnel Plug, contains latex (included in REF 7210152 only)

#### ENDOBUTTON Pac A

7209204	ENDOBUTTON Pac A
ENDOBUTTON Pac A includes:	
014396	2.4 mm x 10" Drill-Tip Guide Wire
014508	2.7 mm x 15" Drill-Tip Passing Pin
013184	Cannulated Endoscopic Drill, 4.5 mm

## ACL/PCL Drill Guide System Components & Accessories

### Cruciate Accessory Pacs

#### ISO-PAC<sup>®</sup>

Comprehensive cruciate accessory pac for reconstruction when isometry is selected. Sterile, single use.

REF	Description
014518	ISO-PAC, latex-free
7210150	ISO-PAC, contains latex
ISO-PAC includes:	
013583	ISOTAC <sup>®</sup>
014399	ISOTAC Pilot Wire
014396	2.4 mm x 10" Drill Tip Guide Wire
014508	2.7 mm x 15" Drill-Tip Passing Pin
014394	1.0 mm x 12" CANNU-FLEX Screw Guide Wire (2)
7210118	7.0 mm CLEAR-TRAC <sup>®</sup> Screw Cannula, latex seal (included in REF 7210150 only)
7207227	7.0 mm CLEAR-TRAC Screw Cannula, latex-free seal (included in REF 014518 only)
013593	Suture Retriever
014477	Cannulated Bone Tunnel Plug, latex-free (included in REF 014518 only)
7210149	Cannulated Bone Tunnel Plug, contains latex (included in REF 7210150 only)

## Chondral Resurfacing Systems

### MOSAICPLASTY<sup>®</sup>



MOSAICPLASTY is an autogenous osteochondral transplantation system that allows for arthroscopic or open treatment of cartilaginous defects of the knee and ankle.

#### MOSAICPLASTY Complete System

REF	Description
7205532	MOSAICPLASTY Complete System Includes components listed on pg. H-60 Drill bits required but not included MOSAICPLASTY Complete Sterilization Tray included (REF 7205507) Trepines for hard bone coring optional but not included

#### MOSAICPLASTY Precision System

7205605*	MOSAICPLASTY Precision System Includes only 2.7 mm, 3.5 mm, and 4.5 mm components Drill bits required but not included MOSAICPLASTY Precision Sterilization Tray included (REF 7205604) Trepines for hard bone coring optional but not included
----------	---

#### MOSAICPLASTY DP Disposable System

*Requires the use of the Graft Placement Drill Guides, Dilators, and Delivery Tamps.*

7209234	Disposable Harvesting Set, 3.5, includes disposable chisel, tamp, and drill bit, blue
7209235	Disposable Harvesting Set, 4.5, includes disposable chisel, tamp, and drill bit, green
7209236	Disposable Harvesting Set, 6.5, includes disposable chisel, tamp, and drill bit, yellow
7209237	Disposable Harvesting Set, 8.5, includes disposable chisel, tamp, and drill bit, red

#### Made to Order Arthroscopic MOSAICPLASTY Guides

Made to Order products have longer production times. Please contact your sales representative or customer service for more information.

3134226	Drill Guide, AMP 4.5 mm with 5 mm slot at distal end
3134227	Drill Guide, AMP 6.5 mm with 5 mm slot at distal end

\* Item shown

# Chondral Resurfacing Systems

## MOSAICPLASTY<sup>®</sup>

### Graft Harvesting

Tubular Chisels (five to ten patient uses)

REF	Description
7207099†	2.7 mm Tubular Chisel
7207098†	3.5 mm Tubular Chisel
7207097†	4.5 mm Tubular Chisel
7205493	6.5 mm Tubular Chisel
7205494	8.5 mm Tubular Chisel

### Graft Harvesting

Chisel Guards

7207208†	2.7 mm Chisel Guard
7207209†	3.5 mm Chisel Guard
7207210†	4.5 mm Chisel Guard
7205499	6.5 mm Chisel Guard
7205500	8.5 mm Chisel Guard

### Graft Harvesting

Harvesting Tamps

7207107†	2.7 mm Harvesting Tamp
7207106†	3.5 mm Harvesting Tamp
7207105†	4.5 mm Harvesting Tamp
7205495	6.5 mm Harvesting Tamp
7205496	8.5 mm Harvesting Tamp

### OPTIONAL – Graft Harvesting

Trephines (for hard bone)

7207089	2.7 mm Trephine
7207088	3.5 mm Trephine
7207087	4.5 mm Trephine
7205497	6.5 mm Trephine
7205498	8.5 mm Trephine
7207103	Trephine Adaptor for 2.7 mm, 3.5 mm, and 4.5 mm sizes.
7205515	Trephine Adaptor for 6.5 mm and 8.5 mm sizes.

### Graft Placement

Drill Guides (five to ten patient uses)

REF	Description
7207214†	2.7 mm Drill Guide
7207215†	3.5 mm Drill Guide
7207216†	4.5 mm Drill Guide
7205501	6.5 mm Drill Guide
7205502	8.5 mm Drill Guide

### Graft Placement

Dilators

7205509†	2.7 mm Dilator
7205510†	3.5 mm Dilator
7205511†	4.5 mm Dilator
7205512	6.5 mm Dilator
7205513	8.5 mm Dilator

### Graft Placement

Delivery Tamps

7207205†	2.7 mm Delivery Tamp
7207206†	3.5 mm Delivery Tamp
7207207†	4.5 mm Delivery Tamp
7205505	6.5 mm Delivery Tamp
7205506	8.5 mm Delivery Tamp

### REQUIRED – Disposables

Drill Bits (non-sterile)

7205508	2.7 mm Drill Bit
7207212	3.5 mm Drill Bit
7207213	4.5 mm Drill Bit
7205503	6.5 mm Drill Bit
7205504	8.5 mm Drill Bit

† MOSAICPLASTY Precision System components

## Chondral Resurfacing Systems

### Chondral Picks

#### Chondral Picks

For chondral resurfacing.



REF	Description
72201883	Chondral Pick, small, 20°
72201884	Chondral Pick, large, 20°
72201885	Chondral Pick, small, 40°
72201886	Chondral Pick, large, 40°
72201736	Chondral Pick, small, 90°



72201732	Universal EndoFemoral Aimer
----------	-----------------------------



## Cruciate Reconstruction

### Leg Holder, Pads and Inserts

#### Leg Holder and Pads



REF	Description
012310*	Leg Holder (Table Clamp not included)
013227	Table Clamp
012311	Replacement Lateral Leg Pad (included with REF 012310)

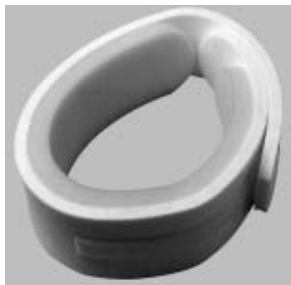

3757	Disposable Leg Holder Pads, non-sterile, 3.5" W x 1.375" D x 38" L, used with Smith & Nephew Leg Holder, REF 2921 (discontinued), case of 12
------	--

#### SURGICAL ASSISTANT® Leg Holder



7209451	SURGICAL ASSISTANT Leg Holder, includes REF 7209450 and 7209452
7209450	SURGICAL ASSISTANT T-Bar
7209452	SURGICAL ASSISTANT Replacement Cross Bar

#### SURGICAL ASSISTANT Leg Holder Foam Inserts



7209456	Reusable Foam Insert, grey, 1 each
7209457	Disposable Foam Insert, blue, box of 20
7209458	Disposable Foam Insert, white, box of 20

#### Made to Order – SURGICAL ASSISTANT Leg Holder, Low Profile

Made to Order products have longer production times. Please contact your sales representative or customer service for more information.



7209453	Low Profile Surgical Assist Leg Holder
7209454	Low Profile Replacement Bar
7209455	Low Profile Replacement Peg and Chain
7209459	Low Profile Disposable Foam Insert, blue, box of 20
7209460	Low Profile Reusable Foam Insert, grey, 1 each

## ARTHROPAK<sup>◇</sup>

### Customized Procedure Kit



#### ARTHROPAK Customized Procedure Kit

Smith & Nephew DYONICS ARTHROPAK Customized Procedure Kits provide increased operational efficiencies and reduced supply expense. You customize your kit with your selection of disposable Smith & Nephew products for any arthroscopic procedure at a reduced cost!

- Free customized service
- Reduced product cost
- Save valuable time and demand on staff
- Streamlined ordering process
- Increased standardization
- Reduced inventory

DYONICS ARTHROPAK Customized Procedure Kits reduce the number of SKUs that need to be ordered and aggregate purchasing volume of arthroscopic products by enabling purchase from a single supplier. Please ask your local sales representative to demonstrate how DYONICS ARTHROPAK Customized Procedure Kits can benefit your practice.



## Shoulder Arthroscopy

Soft Tissue Fixation - Metallic Anchors.....I-1	SURETAC <sup>®</sup> Instrumentation System .....I-20
TWINFIX <sup>®</sup> Ti 5.0 and	SURETAC <sup>®</sup> Instrumentation
TWINFIX Ti 6.5 Suture Anchors .....I-1	Components.....I-21
TWINFIX Ti 3.5 and TWINFIX Ti 2.8	SURETAC <sup>®</sup> IXC Instrumentation System ..I-22
Suture Anchors.....I-2	SURETAC <sup>®</sup> IXC Instrumentation
TWINFIX <sup>®</sup> Ti QUICK-T Fixation System ....I-3	Components.....I-23
Individually packaged anchors and	Soft Tissue Fixation – Sutures .....I-24
accessories .....I-4	ULTRABRAID <sup>®</sup> High Strength Suture.....I-24
Soft Tissue Fixation – Absorbable	Disposable Cannulas .....I-25
Polymer Anchors.....I-5	CLEAR-TRAC <sup>®</sup> COMPLETE Disposable
TWINFIX <sup>®</sup> AB 5.0 and TWINFIX AB	Cannula System .....I-25
6.5 Suture Anchors .....I-5	CLEAR-TRAC <sup>®</sup> FLEXIBLE Disposable
BIORAPTOR <sup>®</sup> 2.9 Suture Anchor .....I-6	Cannula System .....I-26
BIORAPTOR <sup>®</sup> 2.9 AB Suture Anchor	Shoulder Access .....I-27
with Needles .....I-7	Portal Accessory System .....I-27
TAG <sup>®</sup> Suture Anchors and	Shoulder Arthroscopy Portal Products ..I-28
Arthroscopic TAG Instrument Systems ..I-8	Suture Passing .....I-29
Soft Tissue Fixation – Non-absorbable	ELITE <sup>®</sup> PASS Premium Arthroscopic
Polymer Anchors.....I-9	Suture Shuttle.....I-29
BIORAPTOR <sup>®</sup> 2.3 Suture Anchors .....I-9	ACCU-PASS <sup>®</sup> Suture Shuttles .....I-30
BIORAPTOR <sup>®</sup> 2.3 PK Suture Anchor	Reusable Suture Shuttle
with Needles .....I-10	Instrumentation .....I-31
KINSA <sup>®</sup> Suture Anchor .....I-11	Instrumentation Systems .....I-33
TWINFIX <sup>®</sup> PK FT Suture Anchors .....I-12	ELITE <sup>®</sup> Premium Gold System.....I-33
FOOTPRINT <sup>®</sup> PK Suture Anchor .....I-13	ELITE <sup>®</sup> Premium Essential System .....I-34
KINSA <sup>®</sup> RC Suture Anchor.....I-14	Arthroscopic TAG <sup>®</sup> Instrument Systems ..I-35
Non-absorbable TAG <sup>®</sup> Suture Anchors ..I-15	SURETAC <sup>®</sup> Instrumentation Systems.....I-36
Non-Absorbable Polymer Anchors.....I-16	SURETAC <sup>®</sup> and TAG <sup>®</sup> Systems Shoulder
Arthroscopic TAG <sup>®</sup> Instrument Systems ..I-16	Accessory Kit .....I-37
Soft Tissue Fixation – TAG Instrumentation I-17	Patient Positioning .....I-38
Arthroscopic TAG <sup>®</sup> Instrument	TENET T-MAX System (beach chair posi-
Components.....I-17	tioner) .....I-38
Soft Tissue Fixation – Tissue Tacks.....I-18	T-MAX Shoulder Positioners:
SURETAC <sup>®</sup> III Fixation Devices	Components and Accessories.....I-39
and Rapid Delivery System .....I-18	TENET SPIDER Limb Positioner:
SURETAC <sup>®</sup> and SURETAC II Bioabsorbable	Components and Accessories.....I-40
Fixation and Instrumentation.....I-19	T-MAX Shoulder Positioners:
	Components and Accessories.....I-41
	Small Joint Positioners .....I-42
	Disposable Kits for Shoulder
	Arthroscopy.....I-43
	Shoulder Traction Products .....I-44
	Accessories, Instrumentation .....I-45
	ELITE <sup>®</sup> Premium Shoulder System.....I-45
	Accessories, Instrumentation .....I-47
	Arthroscopic Capsular Release.....I-47
	Made to Order.....I-48
	Instruments and Accessories .....I-48
	ARTHROPAK <sup>®</sup> .....I-49
	Customized Procedure Kit.....I-49

# Shoulder Arthroscopy

## Product Highlights



### KINSA® Suture Anchor Family

- Instability and Rotator Cuff versions
- Low profile repair: no knot stack
- Surgeon controls the amount of suture tension applied across tissue

KINSA Suture Anchor Family  
Page I-11



### ACCU-PASS® Suture Shuttles

- Precise control for suture placement and shuttle deployment
- Eight different tip configurations

ACCU-PASS Suture Shuttles  
Page I-30



### BIORAPTOR® Suture Anchor Family

- 2.3 and 2.9 mm sizes available
- Complete line of supporting instrumentation
- Small anchors are easy to maneuver inside the joint
- Handle design protects suture and has a flat striking surface.

BIORAPTOR® Suture Anchor Family  
Page I-6



### TENET Patient Positioning Systems

- T-MAX Shoulder Positioner
- SPIDER Limb Positioner
- Complete line of accessories and small joint components

TENET Patient Positioning  
Page I-40

## Soft Tissue Fixation - Metallic Anchors

### TWINFIX<sup>®</sup> Ti 5.0 and TWINFIX Ti 6.5 Suture Anchors



The unique thread design of the TWINFIX Ti anchors provides extraordinary pullout strength and easy insertion in all bone conditions, and provides superior solutions to the orthopaedic surgeon. Three material options — titanium, PLLA, and polyacetal.

To offer the surgeon flexibility, depending on personal preference and patient profile, TWINFIX anchors are available with DURABRAID<sup>®</sup> and ULTRABRAID<sup>®</sup> suture. The DURABRAID suture is a unique brand of Smith & Nephew braided polyester suture. ULTRABRAID is constructed from UHMW (ultra-high molecular weight polyethylene) and possesses a unique and proprietary braid configuration. This provides ULTRABRAID with its extraordinary strength properties while contributing to its superior handling qualities.

REF	Description	
<b>TWINFIX Ti 5.0 and TWINFIX Ti 6.5 with DURABRAID Suture</b>		
72200766	TWINFIX Ti 5.0 mm Suture Anchor with two #2 preloaded DURABRAID <sup>®</sup> sutures, sterile	EA
7210300	TWINFIX Ti 5.0 mm Suture Anchor with two #2 preloaded DURABRAID sutures with needles, sterile	EA
72200769	TWINFIX Ti 6.5 mm Suture Anchor with two #2 preloaded DURABRAID sutures, sterile	EA
7210214	TWINFIX Ti 6.5 mm Suture Anchor with two #2 preloaded DURABRAID sutures with needles, sterile	EA
<b>TWINFIX Ti 5.0 and TWINFIX Ti 6.5 with ULTRABRAID Suture</b>		
72200755	TWINFIX Ti 5.0 mm Suture Anchor with two #2 preloaded ULTRABRAID <sup>®</sup> sutures <sup>†</sup> , sterile	EA
7210708	TWINFIX Ti 5.0 mm Suture Anchor with two #2 preloaded ULTRABRAID sutures with needles <sup>†</sup> , sterile	EA
72200758	TWINFIX Ti 6.5 mm Suture Anchor with two #2 preloaded ULTRABRAID sutures <sup>†</sup> , sterile	EA
7210709	TWINFIX Ti 6.5 mm Suture Anchor with two #2 preloaded ULTRABRAID sutures with needles, sterile <sup>†</sup>	EA
72200687*	TWINFIX Ti 5.0 mm Suture Anchor with two #2 preloaded ULTRABRAID sutures <sup>†</sup> , sterile, Suture Anchor Pack	3 per BX
72200759*	TWINFIX Ti 5.0 mm Suture Anchor with two #2 preloaded ULTRABRAID sutures <sup>†</sup> , sterile, no needles	5 per BX
<b>TWINFIX Ti 5.0 and TWINFIX Ti 6.5 Instruments</b>		
7210269	6" Drill Guide – 6" x 6.5 mm Spiked Tip for TWINFIX Ti 6.5 mm Anchor	
7209115	6" Drill Guide – 6" x 5 mm Spiked Tip for TWINFIX Ti 5.0 mm Anchor	
7209502	2.5 mm Drill for TWINFIX Ti 3.5 mm and 5.0 mm Anchor	
7210215	3.5 mm Drill for TWINFIX Ti 6.5 mm Anchor	
72201406	12" Suture Passer, sterile	
72201407	2" Suture Passer, sterile	

Ti - Titanium

<sup>†</sup> One ULTRABRAID white suture and one ULTRABRAID co-braid suture

\*US only

Call +1-800-343-5717 (U.S.) or contact your local representative.

## Soft Tissue Fixation - Metallic Anchors

### TWINFIX<sup>®</sup> Ti 3.5 and TWINFIX Ti 2.8 Suture Anchors



The unique thread design of the TWINFIX Ti 3.5 anchor and the TWINFIX Ti 2.8 anchor provides extraordinary pullout strength and easy insertion in all bone conditions, and provides superior solutions to the orthopaedic surgeon. Multiple suture options can save costs by reducing the number of anchors per procedure. The multiple point fixation also provides a stronger repair at the reattachment site.

REF	Description	
<b>TWINFIX Ti 3.5 with DURABRAID<sup>®</sup> suture</b>		
72200763	TWINFIX Ti 3.5 mm Suture Anchor with two #2 preloaded DURABRAID <sup>®</sup> sutures, sterile	EA
7210302	TWINFIX Ti 3.5 mm Suture Anchor with two #2 preloaded DURABRAID sutures with needles, sterile	EA
<b>TWINFIX Ti 3.5 with ULTRABRAID<sup>®</sup> Suture</b>		
72200752	TWINFIX Ti 3.5 mm Suture Anchor with two #2 preloaded ULTRABRAID <sup>®</sup> sutures, sterile	EA
7210707	TWINFIX Ti 3.5 mm Suture Anchor with two #2 preloaded ULTRABRAID sutures with needles <sup>†</sup> , sterile	EA
72200686*	TWINFIX Ti 3.5 mm Suture Anchor with two #2 preloaded ULTRABRAID sutures, sterile, Suture Anchor Pack	3 per BX
72200760*	TWINFIX Ti 3.5 mm Suture Anchor with one #2 preloaded ULTRABRAID sutures, sterile, no needles	5 per BX
<b>TWINFIX Ti 2.8 with DURABRAID Suture</b>		
72200762	TWINFIX Ti 2.8 mm Suture Anchor with one #2 preloaded DURABRAID suture, sterile	EA
72200761	TWINFIX Ti 2.8 mm Suture Anchor with one #1 preloaded DURABRAID suture, sterile	EA
<b>TWINFIX Ti 2.8 with ULTRABRAID Suture</b>		
72200750	TWINFIX Ti 2.8 mm Suture Anchor with one #2 preloaded ULTRABRAID suture, sterile	EA
72200685*	TWINFIX Ti 2.8 mm Suture Anchor with one #2 preloaded ULTRABRAID suture, sterile, Suture Anchor Pack	3 per BX
72200749*	TWINFIX Ti 2.8 mm Suture Anchor with one #2 preloaded ULTRABRAID suture, sterile, no needles	5 per BX
<b>TWINFIX Ti 2.8 and 3.5 Instruments</b>		
7209502	2.5 mm Drill for TWINFIX Ti 3.5 mm and 5.0 mm Anchor	
7209500	6" Drill Guide for Glenoid Placement – 6" x 3.5 mm Spiked Tip for TWINFIX Ti 2.8 mm and 3.5 mm Anchor	
7209506	1.8 mm Drill for TWINFIX Ti 2.8 mm Anchor	
7209503	Awl for TWINFIX Ti 2.8 mm Anchor	

Ti - Titanium

\* One ULTRABRAID white suture and one ULTRABRAID co-braid suture

\*US only

Call +1-800-343-5717 (U.S.) or contact your local representative.



## Soft Tissue Fixation - Metallic Anchors

### TWINFIX<sup>®</sup> Ti QUICK-T<sup>®</sup> Fixation System



#### TWINFIX Ti QUICK-T Fixation System

The TWINFIX TI QUICK-T Fixation System provides a single-step tissue repair method that can be used for primary or secondary tissue fixation. This through-tendon technique combines the proven TWINFIX TI Soft Tissue Anchor with pre-tied knot technology, coupling the anchor with a high strength “T” bar made of PEEK-OPTIMA<sup>®</sup> LT3 polymer from Invibio<sup>®</sup>. The result is a secure, adjustable fixation system that can be used wherever a larger tissue footprint is needed.

The QUICK-T System gives surgeons the unique ability to arthroscopically perform high strength, multi-row repairs more closely resembling those found in open or mini-open procedures. The low profile “T” component is delivered through the standard anchor delivery system, eliminating the need for special cannulae, and the “T” provides a 10 mm tissue bridge once it's deployed and secured to the tissue surface.

The QUICK-T System is also an excellent solution for biceps tenodesis and non-retracted and isolated supraspinatus tear repairs. Using the QUICK-T increases the tissue-to-bone contact area, recreating the natural footprint of the rotator cuff.

REF	Description
72200767	TWINFIX Ti 5.0 mm QUICK-T Fixation System, sterile
72200764	TWINFIX Ti 3.5 mm QUICK-T Fixation System, sterile
7210116	ELITE <sup>®</sup> Premium KNOT MANIPULATOR, QUICK-T, reusable, black loop
7209417	TWINFIX QUICK-T Knot Pusher and Suture Cutter, sterile, disposable
72200768	TWINFIX QUICK-T 5.0 mm implant with QUICK-T Knot Pusher and Suture Cutter, sterile
72200765	TWINFIX QUICK-T 3.5 mm implant with QUICK-T Knot Pusher and Suture Cutter, sterile
7209114	Drill guide, 5" x 4.0 mm, for use with 3.5 mm QUICK-T device
7209502	Drill, 2.5 mm for TWINFIX Ti 3.5 mm and 5.0 mm anchors, suitable for Quick-T Systems

## Soft Tissue Fixation - Metallic Anchors

### Individually packaged anchors and accessories

#### Individually packaged anchors

Anchors packaged without sutures or needles

7209107	TWINFIX <sup>®</sup> Ti 2.8 mm single anchor, sterile
7209108	TWINFIX Ti 4.0 mm single anchor, sterile
7209105	TWINFIX Ti 5.0 mm single anchor, sterile
7209109	TWINFIX Ti 6.5 mm single anchor, sterile

#### Accessories

72201406	12" Suture Passer, single use, sterile
72201407	2" Suture Passer, single use, sterile
7209119	Insertor, TWINFIX Ti 4.0 mm and 6.5 mm, cannulated
7209120	Insertor Shaft, TWINFIX Ti 2.8 mm, short 3", working length
7209121	Insertor Shaft, TWINFIX Ti 2.8 mm, short 6", working length
7209135	Insertor Shaft Handle
7209136	Extractor/Insertion Shaft for use with 5.0 mm and 3.5 mm Ti anchors
7209165	2.5 mm Drill for TWINFIX 4.0 mm, 5.0 mm, and 6.5 mm anchors
7209111	6.5 mm Drill Guide, Spiked Tip



## Soft Tissue Fixation – Absorbable Polymer Anchors

### TWINFIX® AB 5.0 and TWINFIX AB 6.5 Suture Anchors

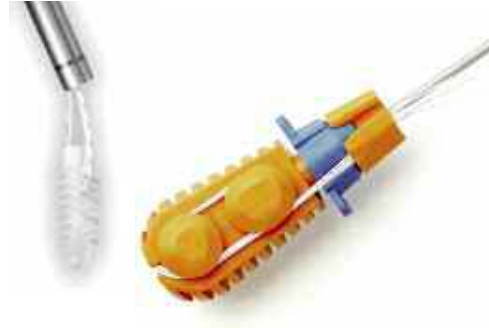

The unique thread design of the TWINFIX AB anchors provides extraordinary pullout strength and easy insertion in all bone conditions, and provides superior solutions to the orthopaedic surgeon. The absorbable material is time tested and proven PLLA.

REF	Description	
<b>TWINFIX AB 5.0 and TWINFIX AB 6.5 with DURABRAID Suture</b>		
72200785	TWINFIX AB 5.0 mm Suture Anchor, PLLA, with two #2 preloaded DURABRAID® sutures, sterile	EA
72200786	TWINFIX AB 5.0 mm Suture Anchor, PLLA, with two #2 preloaded DURABRAID sutures, packaged with threaded dilator, sterile	EA
7210309	TWINFIX AB 5.0 mm Suture Anchor, PLLA, with two #2 preloaded DURABRAID sutures with needles, sterile	EA
7210304	TWINFIX AB 5.0 mm Suture Anchor, PLLA, with two #2 preloaded DURABRAID sutures with needles, packaged with threaded dilator, sterile	EA
72200787	TWINFIX AB 6.5 mm Suture Anchor, PLLA, with two #2 preloaded DURABRAID sutures, sterile	EA
72200788	TWINFIX AB 6.5 mm Suture Anchor, PLLA, with two #2 preloaded DURABRAID sutures, packaged with threaded dilator, sterile	EA
7210211	TWINFIX AB 6.5 mm Suture Anchor, PLLA, with two #2 preloaded DURABRAID sutures with needles, sterile	EA
7210212	TWINFIX AB 6.5 mm Suture Anchor, PLLA, with two #2 preloaded DURABRAID sutures with needles, packaged with threaded dilator, sterile	EA
<b>TWINFIX AB 5.0 and TWINFIX AB 6.5 with ULTRABRAID Suture</b>		
72200777	TWINFIX AB 5.0 mm Suture Anchor, PLLA, with two #2 preloaded ULTRABRAID® sutures†, sterile	EA
7210710	TWINFIX AB 5.0 mm Suture Anchor, PLLA, with two #2 preloaded ULTRABRAID sutures† with needles, sterile	EA
72200778	TWINFIX AB 5.0 mm Suture Anchor, PLLA, with two #2 preloaded ULTRABRAID sutures†, packaged with threaded dilator, sterile	EA
7210711	TWINFIX AB 5.0 mm Suture Anchor, PLLA, with two #2 preloaded ULTRABRAID sutures† with needles, packaged with threaded dilator, sterile	EA
72200688*	TWINFIX AB 5.0 mm Suture Anchor, PLLA, with two #2 preloaded ULTRABRAID sutures†, packaged with one threaded dilator, sterile, Suture Anchor Pack	3 per BX
72200789*	TWINFIX AB 5.0 mm Suture Anchor, PLLA, with two #2 preloaded ULTRABRAID sutures†, packaged with one threaded dilator, sterile, no needles	5 per BX
72200779	TWINFIX AB 6.5 mm Suture Anchor, PLLA, with two #2 preloaded ULTRABRAID sutures†, sterile	EA
7210712	TWINFIX AB 6.5 mm Suture Anchor, PLLA, with two #2 preloaded ULTRABRAID sutures† with needles, sterile	EA
72200780	TWINFIX AB 6.5 mm Suture Anchor, PLLA, with two #2 preloaded ULTRABRAID sutures†, packaged with threaded dilator, sterile	EA
7210713	TWINFIX AB 6.5 mm Suture Anchor, PLLA, with two #2 preloaded ULTRABRAID sutures† with needles, packaged with threaded dilator, sterile	EA

#### Accessories



7209946	TWINFIX AB 5.0 mm threaded dilator, reusable
7210819	TWINFIX AB 6.5 mm threaded dilator, reusable
72201178**	TWINFIX AB 5.0 mm Awl/threaded dilator, reusable
72200819	TWINFIX AB 5.0 mm Suture Anchor threaded dilator, sterile
72200820	TWINFIX AB 6.5 mm Suture Anchor threaded dilator, sterile

AB - Absorbable material  
 PLLA - Poly L lactic acid

† One ULTRABRAID white suture and one ULTRABRAID co-braid suture  
 \*US only  
 \*\*item shown

Call +1-800-343-5717 (U.S.) or contact your local representative.

## Soft Tissue Fixation – Absorbable Polymer Anchors

### BIORAPTOR® 2.9 Suture Anchor



The BIORAPTOR 2.9 Suture Anchor is the secure solution for bioabsorbable fixation. With its cutting edge design and simple "push-in" procedure, BIORAPTOR offers a flexible surgical technique for reliable and effective instability repairs.

An improved eyelet design accommodates either one or two pre-loaded sutures, resulting in excellent suture sliding capability, even in the most challenging conditions, while the anchor's unique rib shape provides superior pullout strength. BIORAPTOR is available with either DURABRAID® or ULTRABRAID® suture.

#### BIORAPTOR 2.9 Suture Anchor

REF	Description	
72200783	BIORAPTOR 2.9 mm Suture Anchor with two #2 preloaded DURABRAID sutures, sterile	EA
72200774	BIORAPTOR 2.9 mm Suture Anchor with one #2 preloaded ULTRABRAID co-braid suture, sterile	EA
72200689*	BIORAPTOR 2.9 mm Suture Anchor with one #2 preloaded ULTRABRAID co-braid suture, sterile, Suture Anchor Pack	3 per BX
72200775	BIORAPTOR 2.9 mm Suture Anchor with two #2 preloaded ULTRABRAID sutures†, sterile	EA
72200690*	BIORAPTOR 2.9 mm Suture Anchor with two #2 preloaded ULTRABRAID sutures†, sterile, Suture Anchor Pack	3 per BX
72201395	INLINE Drill Bit 2.9 mm, suitable for use with KINSA anchor and BIORAPTOR 2.9 mm Anchors	
72201918	INLINE Drill Bit 2.7 mm, suitable for use with the BIORAPTOR 2.9 mm Anchors	
72201388	INLINE Drill Guide - Spiked Tip	
72201389	INLINE Drill Guide - Fishmouth Tip	
72201390	INLINE Drill Guide - Crown Tip	
72201391	INLINE Drill Guide - Offset Fishmouth Tip	
72201392	INLINE Obturator - Blunt Tip	
72201393	INLINE Obturator - Cannulated	
72201394	INLINE Obturator - Trocar Tip	
72201144	3.0 mm T-Handle (manual) Drill bit with depth stop for BIORAPTOR 2.9 mm anchor, not for use with drill guides listed above (see photo)	
72201198	Twist Drill, 3.0 mm for BIORAPTOR 2.9 mm anchor, not for use with drill guides listed above	
72200867	Mallet with Nylon Ends	
72200879	Replacement nylon end caps for mallet (set of 2)	



† One ULTRABRAID white suture and one ULTRABRAID co-braid suture

\*US only

## Soft Tissue Fixation – Absorbable Polymer Anchors

### BIORAPTOR® 2.9 AB Suture Anchor with Needles

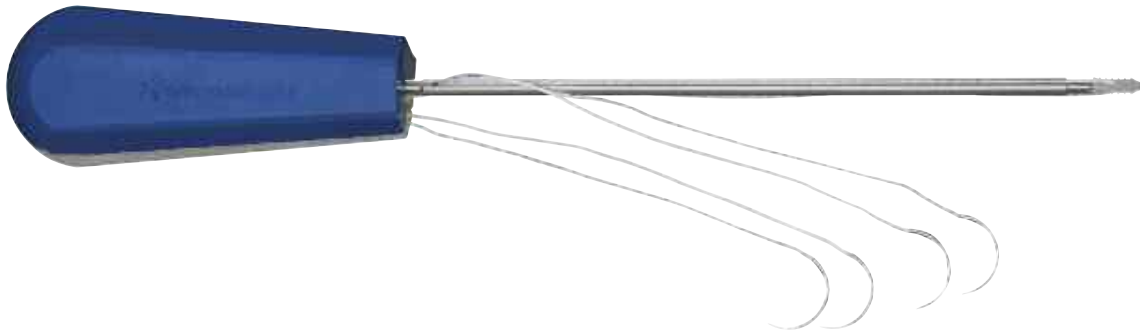

BIORAPTOR® Suture Anchors provide a reliable soft-tissue repair solution for shoulder joint instability repairs. First designed for arthroscopic repair techniques, BIORAPTOR suture anchors are now available with needles to accommodate open and mini-open repair procedures. Available in 2.9 mm diameter, the anchor includes pre-loaded ULTRABRAID® Suture. Each end of the suture includes a swaged-on, 1/2 circle cutting needle, which is housed behind a protective pull-away panel in the inserter handle.

#### BIORAPTOR 2.9 AB Suture Anchor with Needles

REF	Description
72201702	BIORAPTOR 2.9 mm AB Suture Anchor with two ULTRABRAID® #2 sutures with needles, white, cobraid blue
72201705	2.9 mm slotted drill guide
72200867	Mallet with nylon ends
72200879	Replacement nylon end caps for Mallet (set of 2)
72201395	INLINE Drill Bit 2.9 mm, suitable for use with KINSA anchor and BIORAPTOR 2.9 mm Anchors
72201918	INLINE Drill Bit 2.7 mm, suitable for use with the BIORAPTOR 2.9 mm Anchors

## Soft Tissue Fixation – Absorbable Polymer Anchors

### TAG<sup>®</sup> Suture Anchors and Arthroscopic TAG Instrument Systems



TAG Anchors are available in Rod or Wedge styles to suit all surgical preferences. The large diameter of the eyelet allows suture to slide freely, aiding with suturing and knot tying. The Bioabsorbable TAG Anchor is an absorbable suture anchor device used in the treatment of anterior shoulder instability. This anchor is made of polyglyconate, which is currently found in other widely-used devices such as SURETAC<sup>®</sup> absorbable fixation devices and Maxon sutures. The TAG anchor reapposes soft tissue to bone during the critical healing period and is later absorbed, eliminating potential complications related to the use of permanent implants.

#### Bioabsorbable<sup>†</sup> TAG Suture Anchors

Uses suture sizes up to USP #2

REF	Description
013161	Bioabsorbable TAG, 3.7 mm Wedge, sterile
013160	Bioabsorbable TAG, 3.7 mm Rod II, sterile



REF	Description
-----	-------------

#### TAG Arthroscopic Delivery System – 3.7 mm Rod II

014763 TAG Arthroscopic Delivery System – 3.7 mm Rod II

System includes:

014339	TAG Arthroscopic Drill Guide	Optional:	
014341	TAG Arthroscopic Drill, 3.7 mm	014617	Transporter, sterile, box of 4
013191	TAG Arthroscopic Driver, 3.7 mm Rod II	72201895	Transporter II, crescent, sterile, 1 each
014672	Shoulder Knot Pusher	72201896	Transporter II, 30°, sterile, 1 each
014712	Sterilization Tray	72201897	Transporter II, 60°, sterile, 1 each

#### TAG Arthroscopic Delivery System – 3.7 mm Wedge

014726 TAG Arthroscopic Delivery System – 3.7 mm Wedge

System includes:

014339	TAG Arthroscopic Drill Guide	Optional:	
014341	TAG Arthroscopic Drill, 3.7 mm	014617	Transporter, sterile, box of 4
013190	TAG Arthroscopic Driver, 3.7 mm Wedge	72201895	Transporter II, crescent, sterile, 1 each
014672	Shoulder Knot Pusher	72201896	Transporter II, 30°, sterile, 1 each
014712	Sterilization Tray	72201897	Transporter II, 60°, sterile, 1 each

<sup>†</sup> Bioabsorbable suture anchor made of polyglyconate

## Soft Tissue Fixation – Non-absorbable Polymer Anchors

### BIORAPTOR<sup>®</sup> 2.3 Suture Anchors

The BIORAPTOR 2.3 PK Suture Anchor is a small diameter anchor for shoulder, hip and small joint repairs. Made with radiolucent high strength PEEK-OPTIMA<sup>®</sup> from Invibio<sup>®</sup>, the anchor includes one pre-loaded ULTRABRAID<sup>®</sup> suture. It also features the new TWINFIX<sup>®</sup> style handle inserter with depth stop. The new instrumentation makes it easier to maneuver to any location inside the joint, so you can position the repair exactly where you want it.

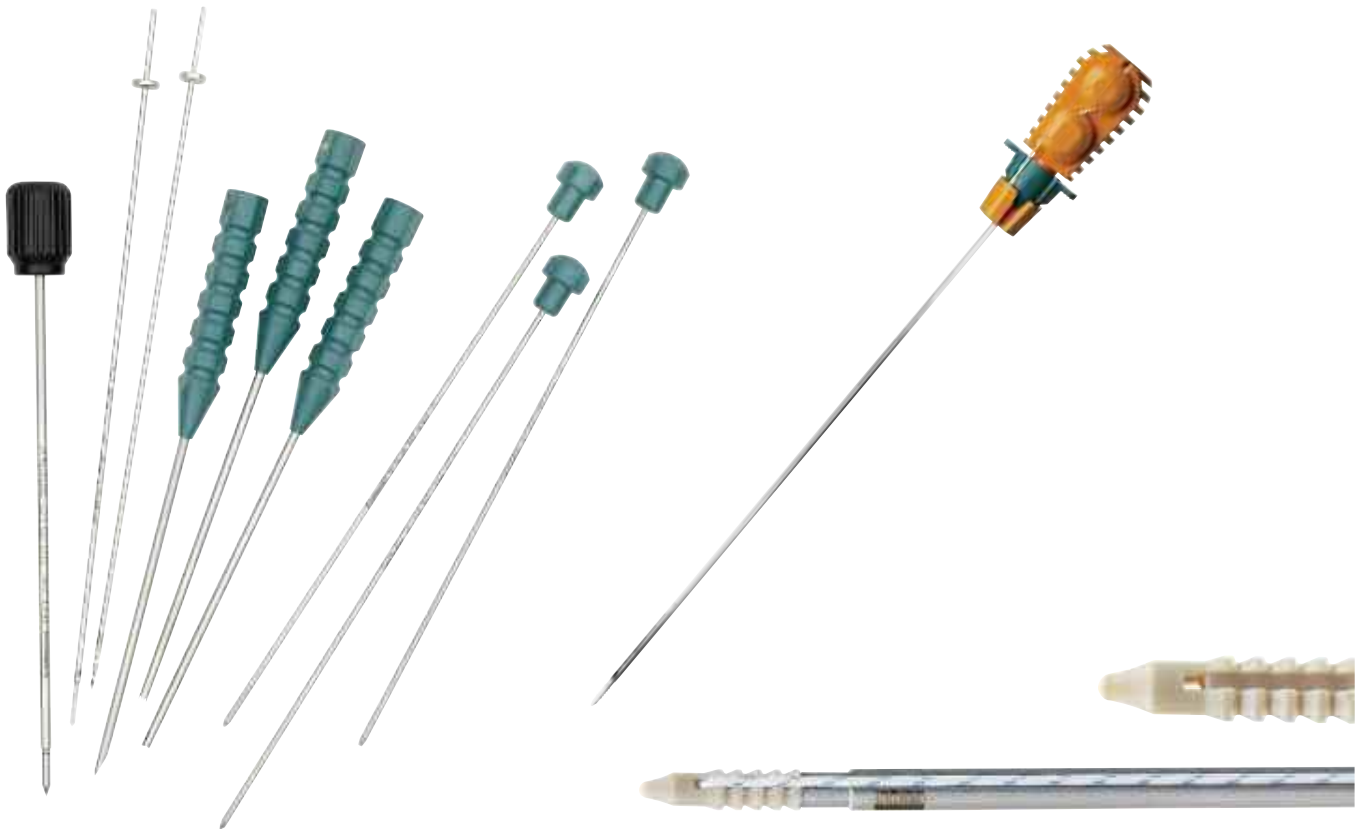

#### BIORAPTOR 2.3 Suture Anchor

REF	Description
72201541	BIORAPTOR 2.3 mm PK Suture Anchor with one ULTRABRAID <sup>®</sup> #2 cobraid-blue suture, sterile
72201542	BIORAPTOR 2.3 mm PK Suture Anchor with one ULTRABRAID <sup>®</sup> #2 cobraid-black suture, sterile
72201543	BIORAPTOR 2.3 mm PK Suture Anchor with one ULTRABRAID <sup>®</sup> #2 white suture, sterile
72201105	INLINE Drill guide – Fishmouth tip
72201106	Non-Cannulated Obturator
72201107	Cannulated Obturator
72201108	Spade Drill bit for 2.3 mm anchor
72201110	INLINE Drill Guide - Spike tip
72201111	INLINE Drill Guide - Crown tip
72201112	INLINE Obturator - Trocar tip
7205395	Guide Wire, Nitinol, 1.2 x 45L, non-sterile, pack of 3
72200867	Mallet with nylon ends
72200879	Replacement nylon end caps for mallet (set of 2)
72201824	Twist tip drill bit for 2.3 mm BIORAPTOR anchor

## Soft Tissue Fixation – Non-absorbable Polymer Anchors

### BIORAPTOR® 2.3 PK Suture Anchor with Needles

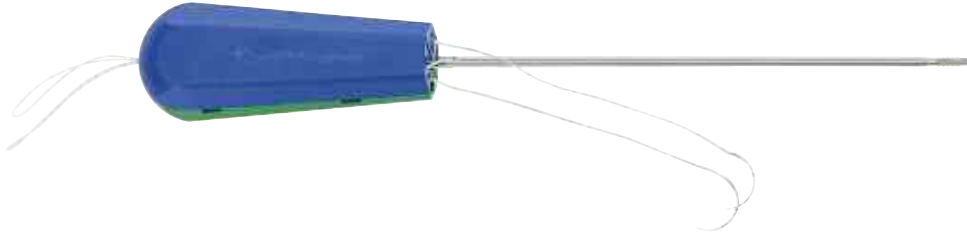

BIORAPTOR® Suture Anchors provide a reliable soft-tissue repair solution for shoulder joint instability repairs. First designed for arthroscopic repair techniques, BIORAPTOR suture anchors are now available with needles to accommodate open and mini-open repair procedures. Available in 2.3 mm diameter, the anchor includes ULTRABRAID® Suture. Each end of the suture includes a swaged-on, 1/2 circle cutting needle, which is housed behind a protective pull-away panel in the inserter handle.

### BIORAPTOR 2.3 PK Suture Anchor with Needles

REF	Description	
72201703	BIORAPTOR 2.3 PK Suture Anchor with one ULTRABRAID® #2 sutures with needles, cobraid blue	EA
72201704	BIORAPTOR 2.3 PK Suture Anchor with one ULTRABRAID® #2 sutures with needles, cobraid black	EA
72201706	2.3 mm slotted drill guide	
72201108	INLINE Drill bit, for use with BIORAPTOR 2.3 mm Anchors	
72200867	Mallet with nylon ends	
72200879	Replacement nylon end caps for Mallet (set of 2)	

## Soft Tissue Fixation – Non-absorbable Polymer Anchors

### KINSA<sup>®</sup> Suture Anchor



The KINSA Suture Anchor, 2.9 mm, is designed for use in arthroscopic glenohumeral joint stability procedures. It is a tap-in anchor made from radiolucent high-strength non-absorbable PEEK-OPTIMA<sup>®</sup> from INVIBIO<sup>®</sup>, the anchor is preloaded with ULTRABRAID<sup>®</sup> co-braid suture and loaded onto a disposable inserter.

A self-locking, sliding knot, based on the Smith & Nephew FAST-FIX<sup>®</sup> Meniscal Repair System, is contained in the anchor allowing secure fixation without tying any knots. The design allows the tension placed on the tissue for fixation to be totally independent of the anchor depth. A suture loop reduces the tissue, leaving a low profile repair with no knot stack in the joint.

REF	Description
72200239	KINSA Suture Anchor, sterile

### Accessories

REF	Description
72201395	INLINE Drill Bit 2.9 mm, suitable for use with KINSA anchor and BIORAPTOR 2.9 anchors
72201388	INLINE Drill Guide – Spiked tip
72201389	INLINE Drill Guide – Fishmouth Tip
72201390	INLINE Drill Guide – Crown tip
72201391	INLINE Drill Guide – Offset Fishmouth tip
72201392	INLINE Obturator – Blunt tip
72201393	INLINE Obturator – Cannulated
72201394	INLINE Obturator – Trocar tip
72200867	Mallet with nylon ends
72200879	Replacement nylon end caps for mallet (set of 2)
72201144*	3.0 mm T-Handle (manual) Drill Bit, not for use with drill guides listed above

\* item shown



## Soft Tissue Fixation – Non-absorbable Polymer Anchors

### TWINFIX® PK FT Suture Anchors



The TWINFIX PK FT anchor is a fully threaded combination tap-in/screw-in anchor designed for rotator cuff repair. Made with radiolucent high strength PEEK-OPTIMA® from Invibio®, the anchor has versions loaded with two or three ULTRABRAID® sutures. It also features the new TWINFIX® style handle inserter with depth stop. An awl is used for hole preparation, and a drill is also available for use with hard bone applications.

#### TWINFIX PK FT Suture Anchor

REF	Description
72201576	TWINFIX PK FT 5.5 mm Anchor with two #2 sutures (COBRAID-blue, COBRAID-black), sterile
72201578	TWINFIX PK FT 5.5 mm Anchor with two #2 sutures (COBRAID-blue, COBRAID-black), sterile, with Awl
72201681	TWINFIX PK FT 6.5 mm Anchor with two #2 sutures (COBRAID-blue, COBRAID-black), sterile
72201683	TWINFIX PK FT 6.5 mm Anchor with two #2 sutures (COBRAID-blue, COBRAID-black), sterile, with Awl
72201577	TWINFIX PK FT 5.5 mm Anchor with three #2 sutures (white, COBRAID-blue, COBRAID-black), sterile
72201579	TWINFIX PK FT 5.5 mm Anchor with three #2 sutures (white, COBRAID-blue, COBRAID-black), sterile, with Awl
72201682	TWINFIX PK FT 6.5 mm Anchor with three #2 sutures (white, COBRAID-blue, COBRAID-black), sterile
72201684	TWINFIX PK FT 6.5 mm Anchor with three #2 sutures (white, COBRAID-blue, COBRAID-black), sterile, with Awl
72201450	Awl 3.8 mm
72201707	Drill, 4.5 mm for use with the 5.5 PK FT anchor in hard bone
72201708	Drill, 5.5 mm for use with the 6.5 PK FT anchor in hard bone
72200867	Mallet with nylon ends



## Soft Tissue Fixation – Non-absorbable Polymer Anchors

### FOOTPRINT® PK Suture Anchor



The FOOTPRINT PK Suture Anchor consists of a non-absorbable polymer (PEEK-OPTIMA® polymer from Invibio®). The sizes include a 5.5 mm anchor, and a back-up size of 6.5 mm. The anchor is composed of two parts, the “outer shell” and the “inner plug.” The design allows the anchor to be tapped in. Then, independent of implantation, the inner plug is screwed down, securing the medial anchor suture limbs that have been captured in the nose of the anchor.

The FOOTPRINT PK Suture Anchor offers a rotator cuff repair technique that allows the surgeon to precisely apply the desired amount of suture tension that is appropriate and customized for each patient. The suture tension can be adjusted even after the anchor is implanted, unlike any competitive product on the market.

### FOOTPRINT PK Suture Anchor

REF	Description
72201697	FOOTPRINT PK Suture anchor, 5.5 mm
72201825	FOOTPRINT PK Suture anchor, 5.5 mm with disposable awl
72201698	FOOTPRINT PK Suture anchor, 6.5 mm
72201826	FOOTPRINT PK Suture anchor, 6.5 mm with disposable awl
72201450	3.8 mm Awl for use with FOOTPRINT PK, TWINFIX® PK FT, and KINSA® RC Anchors
72201915	3.8 mm Tapered awl
72200867	Mallet with nylon ends
72200879	Replacement end caps for mallet (set of 2)
72201707	Spade Drill, 4.5 mm for use in hard bone with the FOOTPRINT PK 5.5 mm anchor and the TWINFIX FT 5.5 mm Anchor
72201708	Spade Drill, 5.5 mm for use in hard bone with the FOOTPRINT PK 6.5 mm anchor and the TWINFIX FT 6.5 mm Anchor
72201915	Disposable tension tuner

## Soft Tissue Fixation – Non-absorbable Polymer Anchors

### KINSA<sup>®</sup> RC Suture Anchor



The KINSA RC Suture Anchor, 5.5 mm combination tap-in and screw-in design, is for use in arthroscopic rotator cuff procedures. Made from radiolucent high strength non-absorbable PEEK-OPTIMA<sup>®</sup> from Invibio<sup>®</sup>, the anchor is preloaded with ULTRABRAID<sup>®</sup> cobraid suture. A self-locking, sliding knot, based on the FAST-FIX<sup>®</sup> Meniscal Repair System technology, is contained within the anchor allowing secure fixation to occur without tying any knots. The design allows surgeons to insert the anchor then manually control exactly how much tension they wish to place across the rotator cuff tissue with tactile feedback. A suture loop surrounding the tissue is reduced, leaving a low profile repair with no knot stack on top of the cuff.

REF	Description
72200895	KINSA RC Suture Anchor, sterile

#### Accessories

REF	Description
72201450	Awl, 3.8 mm
72200867	Mallet with nylon ends
72200879	Replacement nylon end caps for mallet (set of 2)

## Soft Tissue Fixation – Non-absorbable Polymer Anchors

### Non-absorbable TAG<sup>◊</sup> Suture Anchors

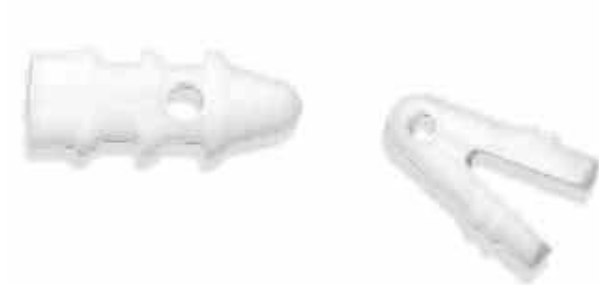

The non-absorbable TAG Anchor is used in the treatment of shoulder instability including Bankart repair and capsular stabilization. The large diameter of the eyelet allows suture to slide freely, aiding with suturing and knot tying.

The anchor is made of implant grade polyacetal, is radiolucent, and has higher strength than bio-absorbable anchors. It uses suture sizes up to USP #2.

#### Non-absorbable<sup>†</sup> TAG Suture Anchors

Made of implant-grade polyacetal, uses suture sizes up to USP #2

REF	Description
013121	Non-absorbable TAG, 3.7 mm Wedge, sterile
014349	Non-absorbable TAG, 3.7 mm Rod II, sterile
014525	Non-absorbable TAG, 3.0 mm Wedge, sterile

<sup>†</sup> Non-absorbable suture anchor made of implant grade polyacetal

## Non-Absorbable Polymer Anchors

### Arthroscopic TAG<sup>®</sup> Instrument Systems



#### TAG Arthroscopic Delivery System – 3.7 mm Rod II

REF	Description		
014763	TAG Arthroscopic Delivery System – 3.7 mm Rod II		
System includes:			
014339	TAG Arthroscopic Drill Guide	Optional:	
014341	TAG Arthroscopic Drill, 3.7 mm	014617	Transporter, sterile, box of 4
013191	TAG Arthroscopic Driver, 3.7 mm Rod II	72201895	Transporter II, crescent, sterile, 1 each
014672	Shoulder Knot Pusher	72201896	Transporter II, 30°, sterile, 1 each
014712	Sterilization Tray	72201897	Transporter II, 60°, sterile, 1 each

#### TAG Arthroscopic Delivery System – 3.7 mm Wedge

014726	TAG Arthroscopic Delivery System – 3.7 mm Wedge		
System includes:			
014339	TAG Arthroscopic Drill Guide	Optional:	
014341	TAG Arthroscopic Drill, 3.7 mm	014617	Transporter, sterile, box of 4
013190	TAG Arthroscopic Driver, 3.7 mm Wedge	72201895	Transporter II, crescent, sterile, 1 each
014672	Shoulder Knot Pusher	72201896	Transporter II, 30°, sterile, 1 each
014712	Sterilization Tray	72201897	Transporter II, 60°, sterile, 1 each

#### TAG Arthroscopic Delivery System – 3.0 mm Wedge

014764	TAG Arthroscopic Delivery System – 3.0 mm Wedge		
System includes:			
014339	TAG Arthroscopic Drill Guide	Optional:	
014340	TAG Arthroscopic Drill, 3.0 mm	014617	Transporter, sterile, box of 4
014338	TAG Arthroscopic Driver, 3.0 mm Wedge	72201895	Transporter II, crescent, sterile, 1 each
014672	Shoulder Knot Pusher	72201896	Transporter II, 30°, sterile, 1 each
014712	Sterilization Tray	72201897	Transporter II, 60°, sterile, 1 each

## Soft Tissue Fixation – TAG Instrumentation

### Arthroscopic TAG<sup>®</sup> Instrument Components

#### TAG Arthroscopic Drill Guide



REF	Description
014339	TAG Arthroscopic Drill Guide

#### TAG Arthroscopic Drills



REF	Outer Diameter	Depth to Collar	Shaft Length
014341	3.7 mm	15.5 mm	7.5" (19 cm)
014340	3.0 mm	10 mm	7.5" (19cm)

#### TAG Arthroscopic Drivers



REF	Description
013191	3.7 mm Rod II
013190	3.7 mm Wedge
014338	3.0 mm Wedge

## Soft Tissue Fixation – Tissue Tacks

### SURETAC<sup>®</sup> III Fixation Devices and Rapid Delivery System



#### SURETAC III Fixation Devices and Rapid Delivery System

SURETAC is the only absorbable fixation tack with over ten years of proven clinical use. The SURETAC Rapid Delivery System enables faster and more efficient delivery of the SURETAC II and SURETAC III fixators. The disposable system employs fewer parts and fewer steps than the existing delivery system, saving time and eliminating the possibility of missing instruments. The Rapid Delivery System ensures sharp and straight drills and guide wires for every implant.

REF	Description
7209818	SURETAC Rapid Delivery System, sterile, single use. System includes: drill, four (4) stainless steel guide wires, delivery instrument (for insertion of REF 014567 SURETAC II Fixator), Angled Head Adaptor (for insertion of SURETAC III Angled Head Fixator), Oval Head Adaptor (for insertion of SURETAC III Oval Head Fixator)

#### SURETAC III Fixation Devices

014567	SURETAC II Fixator with Spikes, sterile
7209900	SURETAC III Fixator, Oval Head, sterile
7209901	SURETAC III Fixator, Angled (18°) Head, sterile

#### SURETAC III Accessories

7209859	SURETAC Glenoid Guide Assembly
7210161	Reusable SURETAC III Driver, angled head
7210162	Reusable SURETAC III Driver, oval head

## Soft Tissue Fixation – Tissue Tacks

### SURETAC<sup>®</sup> and SURETAC II Bioabsorbable Fixation and Instrumentation



SURETAC attaches soft tissue with ease. The tapered shaft and leading edge design ease passage through tissue to bone, while the cannulation ensures precise placement over the guide wire. SURETAC is made of polyglyconate, a bioabsorbable co-polymer, which eliminates concerns about metal in the joint or MRI compatibility. The specifically designed SURETAC Instrumentation System accomplishes soft tissue attachment quickly and effectively without suture and without the hazards of trans-glenoid drilling. SURETAC — the only tack with ten years of helpful clinical data.











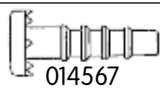

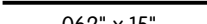
#### SURETAC Bioabsorbable Fixation

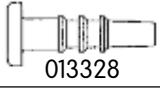
Sterile

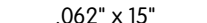
REF	Description
014567*	SURETAC II with spikes, 8 mm x 16 mm
013328*	SURETAC 8 mm x 16 mm
013325*	SURETAC 6 mm x 16 mm

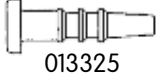
Note: Select the appropriate drill, as indicated in following sections. Drills are not interchangeable.

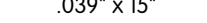
#### SURETAC Drill Selection Table

	IMPLANTS	DRILL	GUIDE WIRE	PAC
SURETAC II with Spikes	 014567	 014633	 .062" x 15" 013334	 014713
8 mm SURETAC	 013328	 013319	 .062" x 15" 013334	 014618
6 mm SURETAC	 013325	 013318	 .039" x 15" 013353	 7207695 <sup>†</sup>

\* Item shown

<sup>†</sup> Made to Order item. Please allow 2-4 weeks for delivery.

Call +1-800-343-5717 (U.S.) or contact your local representative.



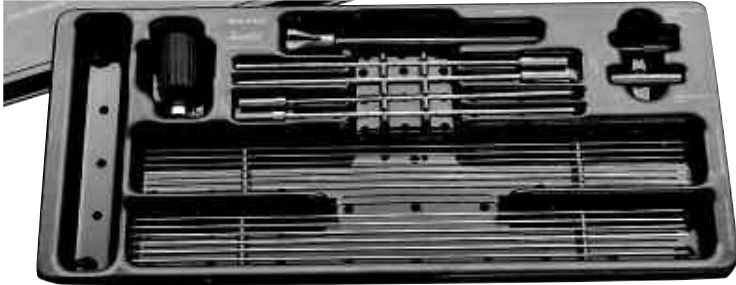

## Soft Tissue Fixation – Tissue Tacks

### SURETAC<sup>®</sup> Instrumentation System



#### SURETAC Instrumentation System

For Arthroscopic Bankart and SLAP Lesion Repair

REF	Description
013381	SURETAC Instrumentation System
	System includes: 013351 SURETAC Driver
	013317 SURETAC Guide Wire Handle
	013316 SURETAC Locking Wrench
	013313 SURETAC Drill Handle
	011632 Sterilization Tray
	NOTE: Repair only, no replacement part



## Soft Tissue Fixation – Tissue Tacks

SURETAC<sup>®</sup> Instrumentation Components

## SURETAC Drills



REF	Implant Size	Cannulation	Used with REF
013318*	6.0 mm	1.0 mm	013325
013319	8.0 mm	1.5 mm	013328
014633	8.0 mm	1.5 mm	014567

## SURETAC Guide Wires

Non-sterile, package of 6



REF	Description
013353	6.0 mm SURETAC Guide Wire, .039" x 15" (.1 cm x 38 cm)
013334	8.0 mm SURETAC Guide Wire, .062" x 15" (.15 cm x 38 cm)





## SURETAC Pacs

Sterile

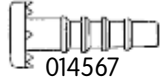
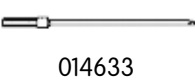
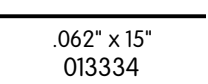
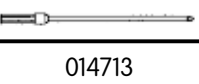

014618*	SURETAC Pac (used with REF 013328, pg. I-14) Pac includes: 8.0 mm SURETAC Drill with two .062" x 15" (.15 cm x 38 cm) Guide Wires
014713	SURETAC II Pac (used with REF 014567, pg. I-14) Pac includes: SURETAC II Drill with two .062" x 15" (.15 cm x 38 cm) Guide Wires

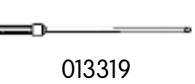
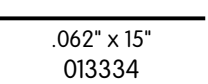
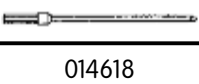
## SURETAC Drill Selection Table

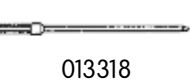
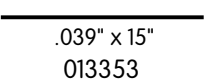
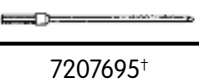
	IMPLANTS	DRILL	GUIDE WIRE	PAC
SURETAC II with Spikes	 014567	 014633	 .062" x 15" 013334	 014713
8.0 mm SURETAC	 013328	 013319	 .062" x 15" 013334	 014618
6.0 mm SURETAC	 013325	 013318	 .039" x 15" 013353	 7207695 <sup>†</sup>

## Optional Components

Can be used with REF 013381



013447 Glenoid Guide



014779\* Cannulated Tissue Tensioner, .077 I.D. (2.0 mm)  
 011030 Tissue Tensioner, non-cannulated  
 72201661 ELITE Premium Knife Rasp

\* Item shown

† Made to Order item. Please allow 2-4 weeks for delivery.

Call +1-800-343-5717 (U.S.) or contact your local representative.

## Soft Tissue Fixation – Tissue Tacks

### SURETAC<sup>®</sup> IXC Instrumentation System



#### SURETAC IXC Instrumentation System

For intra-capsular or extra-capsular approach to arthroscopic Bankart repair; allows a capsular shift to accompany the Bankart repair if required.

REF	Description
014603	SURETAC IXC Instrumentation System
System includes:	
014574	6.0 mm IXC Obturator
014575	6.0 mm IXC Cannula
014570	8.0 mm IXC Obturator
014571	8.0 mm IXC Cannula
014572	IXC Drill Handle
014576	IXC Wire Handle
013351	SURETAC Driver
013316	SURETAC Locking Wrench
014628	Sterilization Tray

## Soft Tissue Fixation – Tissue Tacks

### SURETAC<sup>®</sup> IXC Instrumentation Components

#### SURETAC IXC Drills

3 mm O.D. x 5.5" long, non-sterile.



REF	IXC Implant Size	Cannulation	Used with REF
014573*	6.0 mm	1.0 mm	013325
014641	8.0 mm	1.5 mm	014567

#### SURETAC IXC Guide Wires

Package of 6, non-sterile.



REF	Implant Size	Material Type	Diameter x Length
014581	6.0 mm	Nitinol	.039" x 6.8" (.1 cm x 17 cm)
014568	6.0 mm	Stainless	.039" x 6.8" (.1 cm x 17 cm)
014582	8.0 mm	Nitinol	.062" x 6.8" (.15 cm x 17 cm)
014569	8.0 mm	Stainless	.062" x 6.8" (.15 cm x 17 cm)

#### SURETAC IXC System Components



REF	Description
014575*	6.0 mm IXC Cannula
014574	6.0 mm IXC Obturator
014571	8.0 mm IXC Cannula
014570	8.0 mm IXC Obturator



014572 IXC Drill Handle



014576\* IXC Wire Handle  
013351 SURETAC Driver  
013316 SURETAC Locking Wrench

\* Item shown

## Soft Tissue Fixation – Sutures

### ULTRABRAID<sup>®</sup> High Strength Suture

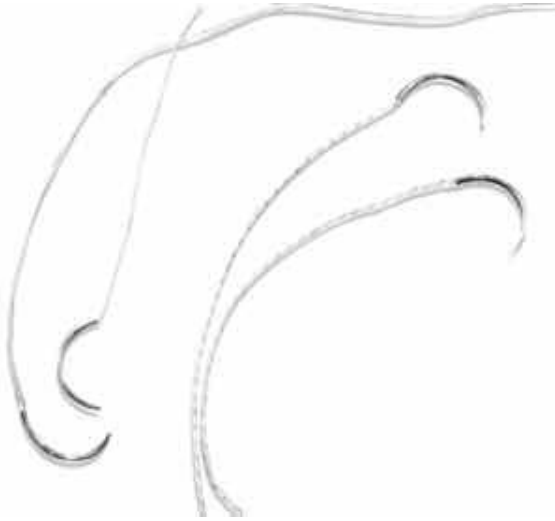

The confidence of a strong, secure shoulder repair begins with ULTRABRAID Suture. This non-absorbable suture is composed of a special ultra high molecular weight (UHMW) polyethylene fiber and features a unique braid configuration. As a result, ULTRABRAID Suture offers special advantages over traditional polyester suture, including higher knot breaking strength, increased lubricity, and a higher resistance to fraying. ULTRABRAID Suture is preloaded on many TWINFIX<sup>®</sup> Suture Anchors (not on TWINFIX PMR 5.0) that have #2 sutures. It is also available in an individual, sterile presentation, in either white or co-braid.

#### ULTRABRAID Suture

REF	Description	
7210914	ULTRABRAID #2 white suture and needle assembly, 38", 10 per package, sterile	BX
7210915	ULTRABRAID #2 co-braid suture and needle assembly, 38", 10 per package, sterile	BX
7211080	ULTRABRAID #2 white suture and needle assembly, 38", 1 per package, sterile	EA
7211081	ULTRABRAID #2 co-braid suture and needle assembly, 38", 1 per package, sterile	EA
72200886	ULTRABRAID #2 white suture, 38", 10 per package, sterile	BX
72200887	ULTRABRAID #2 co-braid suture, 38", 10 per package, sterile	BX
72201797	ULTRABRAID #5 co-braid blue suture and needle assembly, 38", 10 per package, sterile	BX
72201798	ULTRABRAID #5 white suture and needle assembly, 38", 10 per package, sterile	BX
72201799	ULTRABRAID #0 co-braid blue suture and needle assembly, 38", 10 per package, sterile	BX
72201800	ULTRABRAID #0 white suture and needle assembly, 38", 10 per package, sterile	BX
72201801	ULTRABRAID #2-0 co-braid blue suture and needle assembly, 38", 10 per package, sterile	BX
72201802	ULTRABRAID #2-0 white suture and needle assembly, 38", 10 per package, sterile	BX
72201944	ULTRABRAID #5 white suture, 38", 10 per package, sterile	BX

## Disposable Cannulas

### CLEAR-TRAC<sup>®</sup> COMPLETE Disposable Cannula System



- **NEW** Integrated triple-seal design
- **NEW** Suture management system
- Removable cannula cap
- Tall thread configuration
- Transparent polycarbonate body
- Latex free Design

Introducing the all new, updated CLEAR-TRAC<sup>®</sup> COMPLETE Cannula System, enhanced with a robust triple-seal design and an integrated suture management system. These new features, combined with the many existing facets from the previous generation, provide a truly comprehensive cannula solution.

REF

Description

#### CLEAR-TRAC<sup>®</sup> COMPLETE Cannula Family (Sterile, single-use, 10 per box)

REF	Description	EA
72200902	8.5 mm x 90 mm Threaded Cannula, with disposable obturator, green, box of 10, sterile	BX
72200903	8.5 mm x 72 mm Threaded Cannula, with disposable obturator, green, box of 10, sterile	BX
72200904	8.5 mm x 45 mm Threaded Cannula, with disposable obturator, green, box of 10, sterile	BX
72200905	7.0 mm x 72 mm Threaded Cannula, with disposable obturator, grey, box of 10, sterile	BX
72200906	7.0 mm x 72 mm Smooth Cannula, with disposable obturator, grey, box of 10, sterile	BX
72200907	5.5 mm x 72 mm Threaded Cannula, with disposable obturator, blue, box of 10, sterile	BX
72200908	5.5 mm x 45 mm Threaded Cannula, with disposable obturator, blue, box of 10, sterile	BX
72200909	4.5 mm x 72 mm Threaded Cannula, with disposable obturator, purple, box of 10, sterile	BX

#### CLEAR-TRAC COMPLETE Re-usable Obturators

REF	Description	EA
72200910	8.5 mm x 90 mm Reusable Obturator (4.3 mm cannulation), green	EA
72200913	8.5 mm x 90 mm Reusable Solid Obturator, green	EA
72200911	8.5 mm x 72 mm Reusable Obturator (4.3 mm cannulation), green	EA
72200912	8.5 mm x 72 mm Reusable Obturator (1.5 mm cannulation), green	EA
72200914	8.5 mm x 72 mm Reusable Solid Obturator, green	EA
72200915	7.0 mm x 72 mm Reusable Obturator (4.3 mm cannulation), grey	EA
72200916	7.0 mm x 72 mm Reusable Obturator (1.5 mm cannulation), grey	EA

## Disposable Cannulas

### CLEAR-TRAC<sup>®</sup> FLEXIBLE Disposable Cannula System



- **NEW** Integrated triple-seal design
- **NEW** Suture management system
- **NEW** Flexible body material
- **NEW** Thread configuration
- Transparent body
- Capped flow port with optional disposable stopcock
- Latex free Design

Introducing the all new, updated CLEAR-TRAC<sup>®</sup> FLEXIBLE Cannula System. Made from a flexible body material, it provides excellent tactile feedback to help identify structures and may reduce the risk of significant tissue damage. Enhanced with a robust triple-seal design. CLEAR-TRAC<sup>®</sup> FLEXIBLE cannulas also feature an integrated suture management system.

REF Description

#### CLEAR-TRAC<sup>®</sup> FLEXIBLE Cannula Family (Sterile, single-use, 10 per box)

72200424	8.0 mm x 90 mm Threaded Cannula, with disposable obturator, lime green, box of 10, sterile	BX
72200425	8.0 mm x 72 mm Threaded Cannula, with disposable obturator, lime green, box of 10, sterile	BX
72200426	8.0 mm x 72 mm Smooth Cannula, with disposable obturator, lime green, box of 10, sterile	BX
72200427	6.5 mm x 72 mm Threaded Cannula, with disposable obturator, orange, box of 10, sterile	BX
72200428	6.5 mm x 72 mm Smooth Cannula, with disposable obturator, orange, box of 10, sterile	BX
72200429	5.5 mm x 72 mm Threaded Cannula, with disposable obturator and trocar, blue, box of 10, sterile	BX
72200430	5.5 mm x 55 mm Threaded Cannula, with disposable obturator and trocar, blue, box of 10, sterile	BX
72200431	5.5 mm x 55 mm Smooth Cannula, with disposable obturator and trocar, blue, box of 10, sterile	BX
72200432	5.5 mm x 45 mm Threaded Cannula, with disposable obturator and trocar, blue, box of 10, sterile	BX
72200433	4.5 mm x 72 mm Threaded Cannula, with disposable obturator, purple, box of 10, sterile	BX

#### CLEAR-TRAC<sup>®</sup> FLEXIBLE Reusable Obturators

72200899	8.0 mm x 90 mm Reusable Obturator (4.3 mm cannulation), lime green	EA
72200900	8.0 mm x 72 mm Reusable Obturator (4.3 mm cannulation), lime green	EA





#### Accessories

72200658	CLEAR-TRAC <sup>®</sup> Disposable Stopcock	BX
----------	---	----

## Shoulder Access

### Portal Accessory System

#### Portal Accessory System

REF	Description
7207113	Portal Accessory System
	System includes: 013945 4.0 mm Portal Stick x 12" (30 cm) long
	013948 4.0 mm Shoulder Rod x 12" (30 cm) long
	013950 8.0 mm Shoulder Rod Guide, 4 mm cannulation
	014820* 8.0 mm Cannulated Obturator, 1.5 mm cannulation
	014819 5.0 mm Cannulated Obturator, 1.5 mm cannulation
	013334 8.0 mm Guide Wire, .062" x 15" (.15 cm x 38 cm), package of 6
	7207114 Sterilization Tray

#### CLEAR-TRAC® Threaded Cannula with Cannulated Obturator





REF	Description
7207197	CLEAR-TRAC Threaded Cannula, 10 mm I.D., 76 mm long with 4.0 mm cannulated obturator, white, contains latex
	Includes cannulated obturator. Single-use sterile packs, box of 10

\* Item shown

## Shoulder Access

### Shoulder Arthroscopy Portal Products

#### Shoulder Portal System

REF	Description
3803	Shoulder Portal System
	System includes:
3175	Cannulas, 4.5 mm, without holes (2 included in system)
3176	Cannulas, 5.5 mm, without holes (2 included in system)
	3801 Switching Stick, 4.3 mm, not cannulated (13" long)
	3802 Switching Sleeve, 4.5 mm I.D., 5.5 mm O.D. (10" long)
	2787 Wissinger Rod, 4.3 mm (overall length 11.25", shaft length 10")

#### Wissinger Set

REF	Description
2698	Wissinger Set
System includes:	
2787	Wissinger Rod, 4.3 mm (overall length 11.25", shaft length 10")
3175	Cannulas, 4.5 mm, without holes (2 included in system)



## Suture Passing

### ELITE<sup>®</sup> PASS Premium Arthroscopic Suture Shuttle



#### ELITE PASS Premium Arthroscopic Suture Shuttle

The ELITE PASS Premium Arthroscopic Suture Shuttle offers arthroscopic shoulder surgeons a flexible, single-handed method of passing suture through tissue without the need for additional instruments. The reusable instrument features the trusted ACUFEX<sup>®</sup> instrument design, while the disposable needle is composed of highly flexible steel, reducing the potential for breakage. The ELITE PASS design also gives surgeons the ability to pass suture through a single access portal, thus simplifying the procedure and decreasing costs for providers and patients.



REF	Description	
7211020	ELITE PASS Premium Arthroscopic Suture Shuttle with Ratchet	EA
7211021*	ELITE PASS Premium Arthroscopic Suture Shuttle without Ratchet	EA
7210693	ELITE PASS Shuttle Needle, box of 5, sterile	BX
72201840	ELITE PASS Long bite	EA
72201850	ELITE PASS Long bite arthroscopic suture shuttle with ratchet	EA

\* item shown

## Suture Passing

### ACCU-PASS<sup>®</sup> Suture Shuttles



#### ACCU-PASS Suture Shuttles

REF	Description	
7210423	ACCU-PASS 45°, left, sterile	EA
7210424	ACCU-PASS 45°, right, sterile	EA
7210425	ACCU-PASS 45°, upbend, sterile	EA
7210426	ACCU-PASS Straight, sterile	EA
7210427	ACCU-PASS Crescent, sterile	EA
72200418	ACCU-PASS Big Curve, sterile	EA
72200419	ACCU-PASS 70°, upbend, sterile	EA
72201076	ACCU-PASS J-Hook, sterile	EA
72201361	ACCU-PASS monofilament, size #1, single pack, sterile, box of 10	BX
72200721	#0 sterile single pack monofilament, box of 10	BX

#### Accessories used to pass and retrieve suture arthroscopically.

REF	Description
014617	Transporter, single use, sterile, box of 4
72201895	Transporter II, crescent, sterile, 1 each
72201896	Transporter II, 30°, sterile, 1 each
72201897	Transporter II, 60°, sterile, 1 each

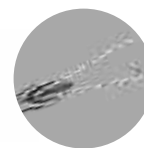

## Suture Passing

### Reusable Suture Shuttle Instrumentation

#### ARTHRO-PIERCE® Premium Instrument System



Single-step suture passage is made simple with ARTHRO-PIERCE instruments. The low-profile, highly sharpened tip allows easy passage through tissue in order to retrieve or apply suture.

Geometrically designed for ultimate flexibility in shoulder repair.

All surfaces electropolished and contoured for smooth passage.

Retrieve or apply suture in one easy step.

REF	Description
7209829	ARTHRO-PIERCE Premium Instrument System
System includes:	
7209496	ARTHRO-PIERCE Instrument, straight
7209497	ARTHRO-PIERCE Instrument, 45° right
7209498	ARTHRO-PIERCE Instrument, 45° left
7209499	ARTHRO-PIERCE Instrument, 35° up
7209182	Sterilization Tray, 13" x 9" x 6"

REF	Description
7210378	ARTHRO-PIERCE, straight with 12° upward bend
7210227	ARTHRO-PIERCE Instrument, 35° up with 9° upward bend
7210226	ARTHRO-PIERCE Instrument, 45° left with 12° upward bend
7210225	ARTHRO-PIERCE Instrument, 45° right with 12° upward bend
72201186	ARTHRO-PIERCE Instrument, curved left, cigar handle
72201187*	ARTHRO-PIERCE Instrument, curved right, cigar handle



\* Item shown

Call +1-800-343-5717 (U.S.) or contact your local representative.

## Suture Passing

### ELITE<sup>®</sup> Cuff Stitch<sup>®</sup> Suture Relays

- Removes the “shuttle” out of suture passage
- Load the suture directly onto the cuff stitch and pass through the tissue in one step
- Improves suture passage
- Can be used alone or with anchors
- Offered in a variety of angles to fill any surgical need
- Reusable



REF Sterile	Description	
7209152	ELITE Cuff Stitch Suture Relay, straight, reusable	EA
7209154	ELITE Cuff Stitch Suture Relay, 30° left, reusable	EA
7209153	ELITE Cuff Stitch Suture Relay, 30° right, reusable	EA
7209155	ELITE Cuff Stitch Suture Relay, 45° right, reusable	EA
7209156	ELITE Cuff Stitch Suture Relay, 45° left, reusable	EA
7209157	ELITE Cuff Stitch Suture Relay, 70° right, reusable	EA
7209158	ELITE Cuff Stitch Suture Relay, 70° left, reusable	EA
7209160	ELITE Cuff Stitch Suture Relay, 180° right, reusable	EA
7209161	ELITE Cuff Stitch Suture Relay, 180° left, reusable	EA

### ACUFEX<sup>®</sup> Suture with Needles

Green, braided, PTFE-impregnated polyester fiber, non-absorbable, single use, sterile, box of 12.



REF	Description	
7207034*	ACUFEX Single-Armed Suture Needle (1 needle), USP #1, 36" (91 cm)	EA
7205539	ACUFEX Double-Armed Suture Needles (2 needles), USP #2, 36" (91 cm)	EA

### Rotator Cuff Bone Stitcher

Developed in conjunction with Professor Herbert Resch, the Rotator Cuff Bone Stitcher efficiently creates bone tunnels in rotator cuff repair.



7207753	Rotator Cuff Bone Stitcher, reusable	EA
---------	--------------------------------------	----

## Instrumentation Systems

### ELITE<sup>®</sup> Premium Gold System

#### ELITE Premium Gold System

REF	Description
7209831	ELITE Premium Gold System

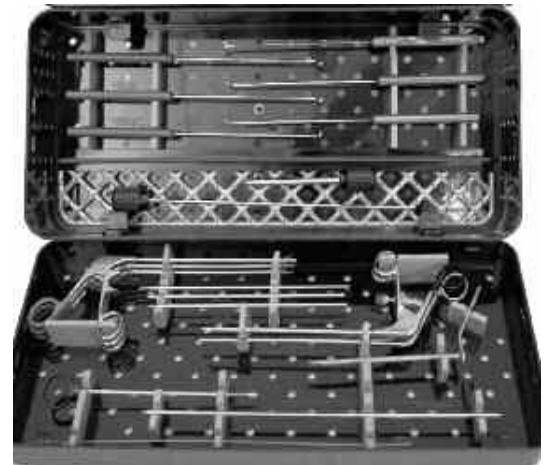

REF	Description
	System includes:
	7209496 ARTHRO-PIERCE <sup>®</sup> , straight
	72201181 ELITE Premium Combination Grasper, red handle
	72201180 ELITE Premium Alligator Locking Grasper, green handle
	72201213 ELITE Premium Full Loop Knot Manipulator, silver handle
	7209494* ELITE Premium Suture Loop Vertical Grasper
	7209492 ELITE Sliding Suture Cutter, silver handle
	7209491 ELITE Double Hook Suture Scissors, black handle
	72201177 ELITE Premium Crochet Hook
	7209152 ELITE Cuff Stitch <sup>®</sup> Suture Relay, straight
	7209154 ELITE Cuff Stitch Suture Relay, 30° left, red handle
	7209153 ELITE Cuff Stitch Suture Relay, 30° right, green handle
	7209157 ELITE Cuff Stitch Suture Relay, 70° right, green handle
	7209158 ELITE Cuff Stitch Suture Relay, 70° left, red handle
	7209160 ELITE Cuff Stitch Suture Relay, 180° right, green handle
	7209161 ELITE Cuff Stitch Suture Relay, 180° left, red handle
	7209134 ELITE Calibrated Probe
	3801 ELITE Switching Stick, 4.3 mm non-cannulated (13" long)
	7209502 ELITE 2.5 mm Drill for 5.0 mm and 3.5 mm anchors
	7209506 ELITE 1.8 mm Drill for 2.8 mm anchors
	7209503 ELITE 1.8 mm Awl for 2.8 mm anchors, T handle
	7209500 ELITE Drill Guide 6" x 3.5 mm Spiked Tip
	7209137 ELITE Instrument Sterilization Tray







## Instrumentation Systems

### ELITE<sup>®</sup> Premium Essential System

#### ELITE Premium Essential System

REF	Description
7209830	ELITE Premium Essential System



REF	Description
System includes:	
	72201181 ELITE Premium Combination Grasper, red handle
	72201180 ELITE Premium Alligator Locking Grasper, green handle
	72201213 ELITE Premium Full Loop Knot Manipulator, silver handle
	7209494 ELITE Premium Suture Loop Grasper Vertical
	7209491 ELITE Double Hook Suture Scissors, black handle
	72201177 ELITE Premium Crochet Hook
	7209153 ELITE Cuff Stitch <sup>®</sup> Suture Relay, 30° right
	7209154 ELITE Cuff Stitch Suture Relay, 30° left
	7209160 ELITE Cuff Stitch Suture Relay, 180° right
	7209161 ELITE Cuff Stitch Suture Relay, 180° left
	7209502 ELITE 2.5 mm Drill for 5.0 mm and 3.5 Anchors
	7209506 ELITE 1.8 mm Drill for 2.8 mm anchors
	7209500 ELITE Drill Guide 6" x 4.0 mm Spiked Tip
	7209137 ELITE Instrument Sterilization Tray

#### Miscellaneous

7209134	ELITE Calibrated Probe
3801	ELITE Switching Stick, 4.3 mm not cannulated (13" long)
7209502	ELITE 2.5 mm Drill for 5.0 mm and 3.5 mm anchors
7209506	ELITE 1.8 mm Drill for 2.8 mm anchors
7209503	ELITE 1.8 mm Awl for 2.8 mm anchors, T handle
7209500	ELITE Drill Guide 6" x 3.5 mm Spiked Tip
7209114	ELITE Drill Guide 5" x 4.0 mm Crown Tip, for use with 3.5 mm QUICK-T <sup>®</sup> device
7209137	ELITE Instrument Sterilization Tray

## Instrumentation Systems

### Arthroscopic TAG<sup>®</sup> Instrument Systems



#### TAG Arthroscopic Delivery System – 3.7 mm Rod II

REF	Description		
014763	TAG Arthroscopic Delivery System – 3.7 mm Rod II		
System includes:			
014339	TAG Arthroscopic Drill Guide		
014341	TAG Arthroscopic Drill, 3.7 mm		
013191	TAG Arthroscopic Driver, 3.7 mm Rod II		
014672	Shoulder Knot Pusher	Optional:	
014712	Sterilization Tray	014617	Transporter, sterile, box of 4

#### TAG Arthroscopic Delivery System – 3.7 mm Wedge

014726	TAG Arthroscopic Delivery System – 3.7 mm Wedge		
System includes:			
014339	TAG Arthroscopic Drill Guide		
014341	TAG Arthroscopic Drill, 3.7 mm		
013190	TAG Arthroscopic Driver, 3.7 mm Wedge		
014672	Shoulder Knot Pusher	Optional:	
014712	Sterilization Tray	014617	Transporter, sterile, box of 4

#### TAG Arthroscopic Delivery System – 3.0 mm Wedge

014764	TAG Arthroscopic Delivery System – 3.0 mm Wedge		
System includes:			
014339	TAG Arthroscopic Drill Guide		
014340	TAG Arthroscopic Drill, 3.0 mm		
014338	TAG Arthroscopic Driver, 3.0 mm Wedge		
014672	Shoulder Knot Pusher	Optional:	
014712	Sterilization Tray	014617	Transporter, sterile, box of 4



## Instrumentation Systems

### SURETAC<sup>®</sup> Instrumentation Systems

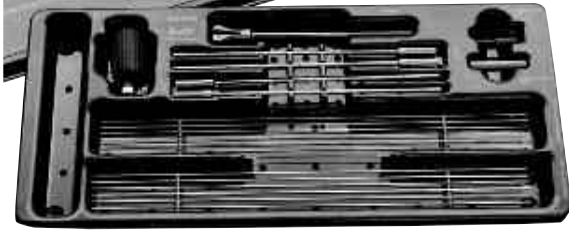

#### SURETAC Instrumentation System

For Arthroscopic Bankart and SLAP Lesion Repair

REF	Description		
013381	SURETAC Instrumentation System		
System includes:			
013351	SURETAC Driver	Optional:	
013317	SURETAC Guide Wire Handle	013447	Glenoid Guide
013316	SURETAC Locking Wrench	014779	Cannulated Tissue Tensioner
013313	SURETAC Drill Handle	011030	Tissue Tensioner, non-cannulated
011632	Sterilization Tray	013977	Knife Rasp



#### SURETAC IXC Instrumentation System

For intra-capsular or extra-capsular approach to arthroscopic Bankart repair; allows a capsular shift to accompany the Bankart repair if required.

014603	SURETAC IXC Instrumentation System
System includes:	
014574	6.0 mm IXC Obturator
014575	6.0 mm IXC Cannula
014570	8.0 mm IXC Obturator
014571	8.0 mm IXC Cannula
014572	IXC Drill Handle
014576	IXC Wire Handle
013351	SURETAC Driver
013316	SURETAC Locking Wrench
014628	Sterilization Tray



## Instrumentation Systems

### SURETAC<sup>®</sup> and TAG<sup>®</sup> Systems Shoulder Accessory Kit



#### Shoulder Accessory Kit

For SURETAC and TAG Arthroscopic Systems

REF	Description
013382	Shoulder Accessory Kit
System includes:	
011030	Tissue Tensioner, non-cannulated
013977	Knife Rasp
013948	4.0 mm Shoulder Rod
013950	8.0 mm Shoulder Rod Guide
013447	Glenoid Guide
011633	Sterilization Tray

## Patient Positioning

### TENET T-MAX System (beach chair positioner)



The T-MAX Shoulder Positioner is a patient positioning system that provides arthroscopy surgeons with the full range of features they need.

Exposure - shoulder pad slides laterally, providing maximum exposure to the operative shoulder

Access - patient can be positioned closer to the side of the OR table to allow maximum accessibility

Adjustability - Hydraulic assist mechanism allows any angle from sitting to supine (0-90°)

Versatility - the T-MAX attaches to most OR tables and is designed for intraoperative use of radiographs and fluoroscopy

REF	Description	
7210996	T-MAX System	BX
System includes:		
7210551	T-MAX Shoulder Positioner	EA
7210552	Adjustable arm board	EA
7210553	T-MAX Cart	EA
7210554	Square Rail Clamps, 2 per box	EA
7210555	Intubation Pad	EA

## Patient Positioning

### T-MAX Shoulder Positioners: Components and Accessories

#### TENET Combination System

REF	Description	
7210997	TENET T-MAX and SPIDER Combination System	BX
System includes:		
7210551	T-MAX Shoulder Positioner	EA
7210552	Adjustable arm board	EA
7210553	T-MAX Cart	EA
7210554	Square Rail Clamps	EA
7210555	Intubation Pad	EA
7210569	SPIDER Limb Positioner	EA
7210570	Piggy Back Connector, 2 per box (required for 7210569)	EA
7210571	Shoulder Connection Bar	EA
7210576	Lateral Shoulder Connection Bar, 2 per box	EA
7210577	Traction Accessory, two included in system	EA
72200918	SPIDER Cart	EA

#### TENET T-MAX Shoulder Positioner and Accessories

7210551	T-MAX Shoulder Positioner	EA
7210552	Adjustable arm board	EA
7210553	T-MAX Cart	EA
7210554	Square Rail Clamps, 2 per box	EA
7210555	Intubation Pad	EA
7210556	Gel Face Mask	EA
7210557	Extended Lateral Support	EA
7210558	Mask Straps (pair)	EA
7210559	Disposable Face Mask, box of 8, disposable	BX
7210560	Knee Bolster	EA
7210562	Gel Head Donut	EA
7210563	Intubation Drape Bar	EA
7210564	Lateral Support Knobs, 2 per box	EA
7210573	Shoulder Stabilization Kit, case of 12, sterile	BX
72200481	T-MAX, Japanese/Eschman	EA
72200482	T-MAX, OPT	EA
72200668	T-MAX, DE	EA
72201185	T-MAX, MA	EA
72200484	Replacement Intubation Tree	EA
72201184	Replacement T-MAX body straps	EA

## Patient Positioning

### TENET SPIDER Limb Positioner: Components and Accessories



The SPIDER Limb Positioner combines strength and flexibility to provide optimal intraoperative positioning for upper extremity procedures. The SPIDER System is ideal for:

Elbow - used for supine, lateral, and prone procedures allowing excellent access and repositioning of the arm.

Shoulder - used in Beach Chair and lateral positions for arthroscopic rotator cuff, instability, total shoulder, and humeral nailing.

Wrist - used for wrist, hand and distal forearm procedures with the ability to pronate, supinate, and deviate.

#### SPIDER System (Beach Chair)

REF	Description	
7210994	SPIDER System (Beach Chair)	BX
System includes:		
7210569	SPIDER Limb Positioner	EA
7210570	Piggy Back Connector, 2 per box (required for 7210569)	EA
7210571	Shoulder Connection Bar	EA
72200918	SPIDER Cart	EA

#### SPIDER System (Lateral Decubitus)

REF	Description	
7210995	SPIDER System (Lateral Decubitus)	BX
System includes:		
7210569	SPIDER Limb Positioner	EA
7210570	Piggy Back Connector, 2 per box (required for 7210569)	EA
7210576	Lateral Shoulder Connection Bar	EA
7210577	Traction Accessory, two included in system	EA
72200918	SPIDER Cart	EA

#### SPIDER Limb Positioner and Accessories

REF	Description	
7210569	SPIDER Limb Positioner	EA
7210570	Piggy Back Connector, 2 per box (required for 7210569)	EA
7210571	Shoulder Connection Bar, 2 per box	EA
7210572	Elbow Connection Bar	EA
7210573	Shoulder Stabilization Kit, disposable, box of 12, sterile	BX
7210574	Elbow Stabilization Kit, disposable, box of 12, sterile	BX
7210576	Lateral Shoulder connection Bar, 2 per box	EA
7210577	Traction Accessory	EA
7210573	Shoulder Stabilization Kit, case of 12, sterile	BX
72200917	SPIDER Limb Positioner, Japan and UK	EA
72200918	SPIDER Cart	EA
7210749	90 Degree Connector	EA
72201183	Universal Hose Kit (North America), 15 Ft.	EA

## Patient Positioning

### T-MAX Shoulder Positioners: Components and Accessories

#### Replacement Kits

REF	Description	
72200483	Strut Replacement Kit	EA
72200484	Intubation Tree Replacement Kit	EA
72200485	Air Swivel Repair Kit	EA
72200486	Foot Pedal Replacement Kit	EA
72200487	Distal Quick Connect Replacement Kit	EA
72200488	Indexing Handle Replacement Kit	EA
72201183	Universal Hose Kit (North America), 15 Ft.	EA

#### International Connectors

REF	Description	
7211096	JE Adapter Leg Kit, 2 units	EA
7211097	JE Rail Clamps, 2 units	EA
7211098	Denyers Adapter Leg Kit, 2 units	EA
7211099	European Square Rails Clamps, 2 units	EA
7211100	Denyers Rail Clamp, 2 units	EA
7211104	Eschman SPIDER Shim	EA
7211105	Japanese SPIDER Shim	EA
72200659	SPIDER Attachment Rail	EA

## Patient Positioning

### Small Joint Positioners

#### Hand / Wrist

REF	Description	
7210543	Large Hand Table (24" x 32")	EA
7210544	Small Hand Table (14" x 27")	EA
7210545	Large 3" Pad	EA
7210546	Small 3" Pad	EA
7210547	Small 2" Pad	EA
7210549	Telescoping Leg	EA
7210550	Large 2" Pad	EA

#### Wrist Arthroscopy (Requires Spider Attachment)

REF	Description	
72200660	Wrist Arthroscopy Accessory	EA
72201550	Small Wrist Stabilization Kits, case of 5, sterile	BX
72201551	Medium Wrist Stabilization Kits, case of 5, sterile	BX
72201552	Large Wrist Stabilization Kits, case of 5, sterile	BX
72200664	Wrist Counter Traction Post	EA
72200665	Finger Trap Sizing Ring	EA
72200666	Wrist Plate	EA

#### Elbow Arthroscopy (Requires Spider Attachment)

REF	Description	
7210575	Western Elbow Positioner	EA
7210572	Elbow Connection Bar, box of 2	EA
7210574	Elbow Stabilization Kit, case of 12, sterile	BX

#### Hip Arthroscopy (Requires Spider Attachment)

REF	Description	
72201425	Boot, Hard Shell, Spider	EA
72201427	Maxi Traction Accessory	EA

NOTE: Hip Arthroscopy System utilizes a Fracture Table with a TENET Fracture Table Adaptor. Please contact Tenet with Fracture Table type to get correct Adaptor.

#### Fracture Management

7210566	Fracture Support with Gel Pad	EA
7210567	TFS Pad, replacement part	EA
7210568	Table Stabilization Straps, replacement part	EA

## Patient Positioning

### Disposable Kits for Shoulder Arthroscopy

#### Arthroscopic Acromioplasty Surgi-Pak, EP-1° Style



REF	Description
7205453	Arthroscopic Acromioplasty Surgi-Pak, EP-1 Style
Surgi-Pak includes:	
7205326	4.0 mm Acromionizer Burr
7205307	5.5 mm Full Radius Blade
4616	5.5 mm Plastic Operative Cannula Set (2 cannulas included)
N/A	Electrosurgery Switchpen with 90° Electrode
N/A	18 Gauge Spinal Needles, 6" (15 cm) long (3 included)
72200195	Shoulder Suspension Kit, latex-free

#### Latex-free Shoulder Suspension Kit

Sterile, disposable, latex-free, box of 6 kits.





72200195	Shoulder Suspension Kit, latex-free
Kit includes:	
	COBAN™ LF wrap
	Rope with S-Hook
	Arm Drape/Stockinette

## Patient Positioning

### Shoulder Traction Products

#### Shoulder Holder/Traction

	REF	Description
	3066	Shoulder Holder
	3144	Shoulder Traction Holder, supplied with S-hook
	7207340*	Shoulder Holder
	Replacement parts (included with 7207340)	
	354009	S-Hook
	354001	Traction Rope
	354008	Slide Bar
	8104983**	Rail conversion kit for Marquet Bed Rails

\* Item shown

\*\* MTO – allow 4-6 weeks

Call +1-800-343-5717 (U.S.) or contact your local representative.









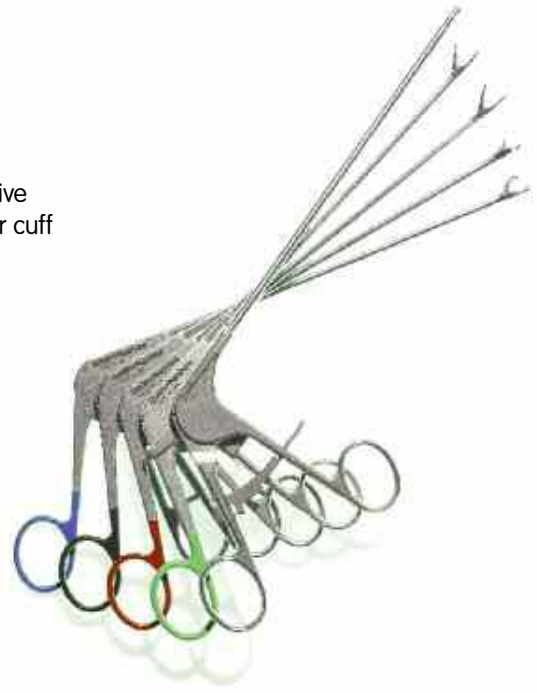

## Accessories, Instrumentation

### ELITE<sup>®</sup> Premium Shoulder System

#### ELITE Premium Shoulder Instruments

The ELITE Premium Shoulder Instruments offer the surgeon comprehensive flexibility in arthroscopic and mini-open shoulder repairs, such as rotator cuff and Bankart repairs. Smith & Nephew shoulder instruments have been designed to facilitate an easier and more efficient approach to surgery.



	REF	Description
	72201179	ELITE Premium Suture Loop Horizontal Grasper, blue handle
	72201180*	ELITE Premium Alligator Locking Grasper, green handle
	72201181*	ELITE Premium Combination Grasper, red handle
	7209494*	ELITE Premium Suture Loop Vertical Grasper, blue handle
	72201179	ELITE Premium Suture Loop Horizontal Grasper, blue handle
	72201688	ELITE Premium Grasper, Tapered, blue handle
	7209492*	ELITE Sliding Suture Cutter (for use with ULTRABRAID <sup>®</sup> )
	72202065*	ELITE Premium Open Face Sliding suture cutter, loop handle (for use with ULTRABRAID <sup>®</sup> )

\* Item shown

Call +1-800-343-5717 (U.S.) or contact your local representative.

## Accessories, Instrumentation

### ELITE<sup>®</sup> Premium Shoulder System



7209491\*

ELITE Double Hook Suture Scissors



72201659\*

ELITE Premium Hook Knife



7209145

ELITE Crochet Hook

72201177\*

ELITE Premium Crochet Hook



72201213\*

ELITE Premium Full Loop KNOT MANIPULATOR<sup>®</sup>, silver handle

7210116

ELITE KNOT MANIPULATOR, QUICK-T<sup>®</sup>, black handle

72201661\*

ELITE Premium Knife Rasp



72201660\*

ELITE Premium Bankart Rasp

013949

Shoulder Elevator

## Accessories, Instrumentation

### Arthroscopic Capsular Release

#### Capsular Release Punch

The geometry of these instruments, developed in conjunction with the late Dr. Doug Harryman II, will assist you in complete arthroscopic capsular release as a treatment for frozen shoulder. The extended nose of the instruments allows blunt dissection between the capsule and surrounding musculature. The pinless hinge and sharp cutting edges, synonymous with ACUFEX® instruments, offer you clean, efficient surgery.



	REF	Description
	7207539	Capsular Release Punch, straight
	7207540	Capsular Release Punch, upbiter
	7207541	Capsular Release Punch, upswept

#### TAG® Arthroscopic System Components

	014672	Shoulder Knot Pusher
---	--------	----------------------

#### T-FIX® RCG Disposables

For use with T-FIX RCG Instrument System (discontinued).

REF	Description
014670	T-FIX Suture Bar, 1.8 mm, with 2 preloaded T-FIX suture bars
014771	T-FIX RCG Drill Pac, sterile, with 1 drill and 2 sleeves
014762	T-FIX RCG Drill Pac, non-sterile, with 1 drill and 2 sleeves

## Made to Order Instruments and Accessories

Made to Order products have longer production times. Please contact your sales representative or customer service for more information.

### SURETAC<sup>®</sup> Disposable Pacs

REF	Description
7207695	SURETAC Pac (used with REF 013325, pg. I-14) includes 6.0 mm SURETAC Drill with two .039" x 15" (.1 cm x 38 cm) Guide Wires

### Titanium T-FIX<sup>®</sup> RCG

6900871	T-FIX RCG with Titanium T-Bar
---------	-------------------------------

### Accessories

7207739	Knot Pusher, shoulder
7207753	Shoulder Stitcher
7207771	Suture Passer Hook
7207773	Suture Passer Crochet Hook
7207772	Suture Pusher
013577	45° Stitcher Cleaning Wire, non-sterile
6900875	TAG <sup>®</sup> Drill Guide, with slotted windows

## ARTHROPAK<sup>®</sup>

### Customized Procedure Kit



#### ARTHROPAK Customized Procedure Kit

Smith & Nephew DYONICS<sup>®</sup> ARTHROPAK Customized Procedure Kits provide increased operational efficiencies and reduced supply expense. You customize your kit with your selection of disposable Smith & Nephew products for any arthroscopic procedure at a reduced cost!

- Free customized service
- Reduced product cost
- Save valuable time and demand on staff
- Streamlined ordering process
- Increased standardization
- Reduced inventory

DYONICS ARTHROPAK Customized Procedure Kits reduce the number of SKUs that need to be ordered and aggregate purchasing volume of arthroscopic products by enabling purchase from a single supplier. Please ask your local sales representative to demonstrate how DYONICS ARTHROPAK Customized Procedure Kits can benefit your practice.

# J

## Small Joint Arthroscopy

Small Joint Suture Anchors and Accessories ..J-1	
MINI-TAG° Systems .....	J-2
Small Joint Arthroscopy Distraction .....	J-3
Guhl Non-Invasive Ankle Distractor System .....	J-3
Ferkel Thigh System .....	J-3
Limb Positioners .....	J-4
Small Joint Arthroscopy Instrumentation.....	J-5
Foot and Ankle Arthroscopy Instruments .....	J-5
Hand and Wrist Instruments .....	J-7
Small Joint Cannula Sets.....	J-8
Shaver Systems .....	J-10
Smith & Nephew DYONICS° Motor Drive Units .....	J-10
Visualization .....	J-11
Small Joint Arthroscopes .....	J-11
Procedure Specific Solutions	
Triangular Fibrocartilage Complex.....	J-12
Flexor Tendon Release – Trigger Finger System.....	J-13
Carpal Tunnel Ligament Repair – ECTRA° II Systems .....	J-14
ARTHROPAK° .....	J-19
Customized Procedure Kit.....	J-19

## Small Joint Suture Anchors and Anchor Accessories



72201881



72202067



72202019



72201882



72201805



72201806

The new Smith & Nephew anchor systems are designed for demanding hand/wrist and foot/ankle procedures. The innovative hand design simplifies surgical procedures.

Each inserter comes pre-loaded with ULTRABRAID® sutures, needles and anchor. A simple twist of the handle provides easy suture deployment.

REF	Description
<b>PEEK Anchors</b>	
72201881*	DYNAMITE® 2.0 mm PEEK with 1 ULTRABRAID Suture Size 2-0 and Needles
72201882*	SPYROMITE® 2.0 mm PEEK with 1 ULTRABRAID Suture Size 2-0 and Needles
72201806*	RAPTORMITE® 3.0 mm PEEK with 2 ULTRABRAID Sutures Size 0 and Needles
<b>Absorbable Anchors</b>	
72201805*	RAPTORMITE 3.7 mm PLLA with 2 ULTRABRAID Sutures Size 0 and Needles
<b>Titanium Anchors</b>	
72202019*	MINITAC® 2.0 mm Ti with 2 ULTRABRAID® Sutures Size 2-0 and Needles
72200795	MINITAC 2.0 mm Ti with 2 DURABRAID® Sutures Size 3-0 and Needles (Anchor package also includes: Disposable Drill Guide and Disposable Drill)
7210303	MINITAC 2.0 mm Ti with 2 DURABRAID Sutures Size 3-0 and Needles (Anchor package also includes: Disposable Drill Guide and Disposable Drill)
72202067*	TWINFIX® 2.8 mm Ti with 2 ULTRABRAID Sutures Size 2-0 and Needles
72200796	TWINFIX 2.8 mm Ti with 2 DURABRAID Sutures Size 2-0 and Needles
7210301	TWINFIX 2.8 mm Ti with 2 DURABRAID Sutures Size 2-0 and Needles
<b>Anchor Accessories</b>	
72202040	1.8 mm Drill and Guide for SPYROMITE 2.0 mm and MINITAC 2.0 mm Suture Anchor
72202082	1.6 mm Drill and Guide for DYNAMITE 2.0 mm Suture Anchor
72202038	3.2 mm Drill and Guide for RAPTORMITE 3.7 mm Suture Anchor
72202039	2.6 mm Drill and Guide for RAPTORMITE 3.0 mm Suture Anchor
7209506	1.8 mm Drill for TWINFIX 2.8 mm Suture Anchor
7209118	Drill Guide for TWINFIX 2.8 mm Suture Anchor

## Small Joint Suture Anchors and Anchor Accessories

### MINI-TAG<sup>®</sup> Systems

The MINI-TAG instrument systems are indicated for ulnar collateral ligament repair, scapholunate dissolution, flexor avulsions, and carpometa-carpal arthroplasty.

#### MINI-TAG System, 2.0 mm

REF	Description
014666*	MINI-TAG System, 2.0 mm
System includes:	
014619	MINI-TAG Drill Guide
014333	MINI-TAG Driver, 2.0 mm
014324	MINI-TAG Drill, 2.0 mm
014629	MINI-TAG Instrument System Sterilization Tray

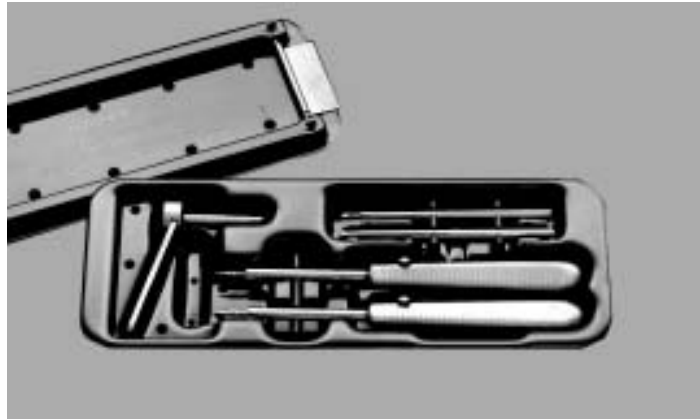





#### MINI-TAG System, 3.0 mm

014693	MINI-TAG System, 3.0 mm
System includes:	
014619	MINI-TAG Drill Guide
014331	MINI-TAG Driver, 3.0 mm
014326	MINI-TAG Drill, 3.0 mm
014629	MINI-TAG Instrument System Sterilization Tray

#### Accessory

72201406	12" Suture passer
----------	-------------------

#### MINI-TAG<sup>®</sup> Components

	REF	Description
	014321*	2.0 mm MINI-TAG Wedge
	014323	3.0 mm MINI-TAG Wedge
	014619	MINI-TAG Drill Guide
	014333	2.0 mm MINI-TAG Driver
	014331	3.0 mm MINI-TAG Driver
	014324	2.0 mm MINI-TAG Drill, depth to collar 8.6 mm, shaft 4.5" long
	014326	3.0 mm MINI-TAG Drill, depth to collar 8.6 mm, shaft 4.5" long

\* Item shown

Call +1-800-343-5717 (U.S.) or contact your local representative.



## Small Joint Arthroscopy Distraction

### Ferkel Thigh System



REF	Description
72201812*	Ferkel Thigh Holder (System includes 1 disposable pad)
013227	Table Clamp

#### Disposable component

72201813	Foam Pad (box of 1)
72201814	Foam Pad (box of 5)

## Guhl Non-Invasive Ankle Distractor System

This optimal design addresses low-cost, simple, non-invasive ankle distraction.



REF	Description
7207079	Guhl Non-Invasive Ankle Distractor System
System includes:	
7207023*	Guhl Non-Invasive Ankle Distractor
014459*	Support Bar
013227*	Table Clamp
7207032	Guhl Non-Invasive Ankle Distractor Sterilization Tray



#### Individual Components and Replacement Parts:

7207023	Guhl Non-Invasive Ankle Distractor
346103	Replacement Loop Adaptor
40005103	Replacement Hex Acorn Nut
014466	Replacement pins for Ankle Distractor (box of 6)
014459	Support Bar
013227	Table Clamp
7207032	Guhl Non-Invasive Ankle Distractor Sterilization Tray
3134143	Clamp for larger beds
386053	Loop plate assembly

#### Disposable component

014407*	Ankle Distractor Foot Straps, sterile, latex free (box of 6)
---------	--



\* Item shown

## Small Joint Arthroscopy Distraction Limb Positioners

### TENET Wrist Tower Kit and Accessories

REF	Description
72202056	Telnet Wrist Tower Kit and Accessories

#### System includes:

72202114	TENET Wrist Tower
7210577	Traction Accessory
72200660	Wrist Arthroscopy Accessory
72200666	Wrist plate

#### Disposable Components:

72201550	Small Wrist Stabilization Kits, (Case of 5)
72201551	Medium Wrist Stabilization Kits, (Case of 5)
72201552	Large Wrist Stabilization Kits, (Case of 5)

#### Accessories:

013227	Table Clamp
--------	-------------

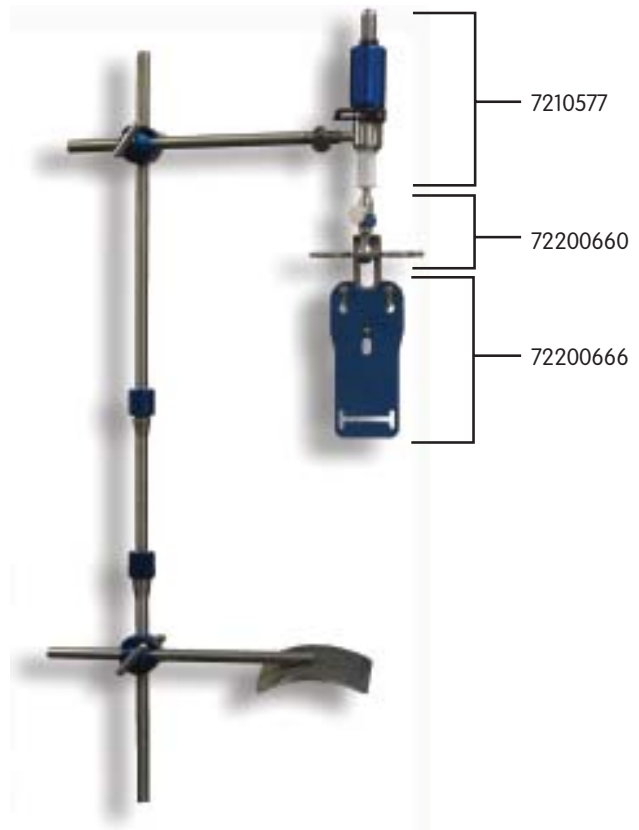

### SPIDER Limb Positioner

7210569	SPIDER Limb Positioner
7210570	Piggy Back Connector, 2 per box, (required for 7210569)
7210571	Shoulder Connection Bar
7210572	Elbow Connection Bar
7210573	Shoulder Stabilization Kit, disposable, box of 12, sterile
7210574	Elbow Stabilization Kit, disposable, box of 12, sterile
7210575	Western Elbow Positioner
7210576	Lateral Shoulder Connection Bar
7210577	Traction Accessory



### Hand Tables











7210543	Large Hand Table (24" x 32")
7210544	Small Hand Table (14" x 27")
7210545	Large 3" Pad
7210546	Small 3" Pad
7210547	Small 2" Pad
7210549	Telescoping Leg
7210550	Large 2" Pad
7210554	North American Rail Clamps (2 per box) (These clamps are required to secure the Hand Table to the OR table)

# Small Joint Arthroscopy Instrumentation

## Foot and Ankle Arthroscopy Instruments

### Smith & Nephew ACUFEX® Small Joint Arthroplasty System

Low profile, hand-held instruments designed for better access, grasping and maneuverability for foot, ankle and elbow procedures.

REF	Description
7207036	Small Joint Arthroplasty System
	System includes:
 014843	RAPTOR® Jr. Punch
 014844	Blunt Nose Jr. Punch
 014845	PITBULL® Jr. Grasper
 014847	Closed Curette
 014896*	Osteotome
 014848	Probe
 7207019	Small Joint Arthroplasty System Sterilization Tray
 013219	Small Joint Grasper
 3499	DYOvac® Straight Suction Punch, 2.5 mm
 014846*	Open Curette
72201795	Small Joint Curette System (also includes 011703 sterilization tray)
	System includes:
72201376	15° Open Curette, 4 mm
72201377	30° Open Curette, 2.5 mm
72201378	15° Open Curette, 2.5 mm
72201379*	15° Anterior Lesion Curette, 2.5 mm
011703	Sterilization tray

\* Item shown

## Small Joint Arthroscopy Instrumentation

### Foot and Ankle Arthroscopy Instruments

#### MICRO VECTOR® Drill Guide System

A straightforward, versatile approach to arthroscopically assisted pin placement in either the ankle or wrist.



REF	Description
4314	MICRO VECTOR Drill Guide System
System includes:	
4291	MICRO VECTOR Drill Guide
4297	Offset Drill Guide
4295	K-Wire Guide, .045" (1.1 mm)
4296	K-Wire Guide, .062" (1.6 mm)
7204612	K-Wire Guide, .125" (3.2 mm)
1030088	MICRO VECTOR Surgical Technique Manual

#### Small Joint Microfracture Picks



REF	Description
72202153	Microfracture Pick 90°, Small
72202154	Microfracture Pick 65°, Small
72202155	Microfracture Pick 40°, Small









# Small Joint Arthroscopy Instrumentation

## Hand and Wrist Instruments

### ACUFEX® Loop Handle

Micro instruments designed to provide maximum grasping, resecting capability, and excellent maneuverability for easy access to tight, small joints (wrist, elbow, and ankle).

All feature pinless hinge design for unparalleled strength and reliability.

REF	Description
7207868	Micro Instrument System
	System includes:
	7207598 MicroGraspers, straight
	7207599 MicroGraspers, Up 10°
	7207600 MicroPunch, straight
	7207601 Teardrop punch, right
	7207602 Teardrop punch, left
	3312* Probe
	3134236** Small Joint Probe
	3134237** Small Joint Elevator
	3499 DYOvac® Straight Suction Punch, 2.5 mm
	7207935 Sterilization Tray; holds up to eight Micro Instruments, plus probe

### Small Joint Microfracture Picks

REF	Description
	72202153 Microfracture Pick 90°, Small
	72202154 Microfracture Pick 65°, Small
	72202155 Microfracture Pick 40°, Small

\* Item shown

\*\* Made to order. Please contact your sales representative for more information.

## Small Joint Cannula Sets

### Small Joint Cannula Sets

REF	Description
4294	2.2 mm Operative Cannula Set for 1.9 mm SHORT SCOPE with light post on OPPOSITE SIDE of direction of view

Set Includes:

3865	2.2 mm Short Cannula, with flow port
3866	2.2 mm Short Trocar, sharp tip
3867	2.2 mm Short Obturator, conical tip
3312	TMJ/Wrist Probe



3713	2.9 mm Operative Cannula Set for 2.7 mm LONG SCOPE with light post on OPPOSITE SIDE of direction of view
------	--

Set Includes:

3672	2.9 mm Short Cannula with finger post (2 per set)
3785	2.9 mm Short Trocar, sharp tip
3807	2.9 mm Short Obturator, conical tip
3671	Irrigation Extender, single-valve, fixed
3696	Infusion Adaptor



3800	2.9 mm Operative Cannula Set for 2.7 mm SHORT SCOPE with light post on OPPOSITE SIDE of direction of view
------	---

Set Includes:

3781	2.9 mm Short Cannula with flow port (2 per set)
3807	2.9 mm Short Obturator, conical tip
3786	2.9 mm Short Obturator, blunt tip
3312	TMJ/Wrist Probe



## Small Joint Cannula Sets

### Small Joint Cannula Sets



REF	Description
4317	3.6 mm Operative Cannula Set for 2.7 mm SHORT SCOPE with light post on OPPOSITE SIDE of direction of view
Set Includes:	
4308	3.6 mm Operative Cannula, single-valve, fixed
4309	3.6 mm Sharp Trocar
4310	3.6 mm Obturator, conical tip



3714	2.9 mm Diagnostic Cannula Set for 2.7 mm LONG SCOPE with light post on OPPOSITE SIDE of direction of view
Set Includes:	
4419	2.9 mm Cannula with flow port
3691	2.9 mm Trocar, sharp tip
3692	2.9 mm Obturator, conical tip

### Operative Cannulas and Inflow Cannulas



3672	2.9 mm Short cannula with finger post
6900853*	2.9 mm Short cannula, low flow, double valve (Use with 2.7 mm short arthroscope)
6900392	2.9 mm Standard cannula, low flow, double valve, rotatable (Use with 2.7 mm standard length arthroscope)
3807	Conical Obturator (Use with 3672 and 6900853)
7210715	3.8 mm Short cannula, double valve (Use with 2.7 mm short arthroscope)
7207789	3.8 mm Short cannula, single valve
4527	3.8 mm Obturator, conical tip (Use with 7210715 or 7202289)
7205999	4.6 mm Standard cannula, high flow, double valve (Use with 2.7 mm standard arthroscope)
72200121	4.6 mm Standard cannula, high flow, single valve (Use with 2.7 mm standard arthroscope)
4439	4.6 mm Obturator, conical tip (Use with 7205999 or 72200121)

\*Item shown

## Shaver Systems

### Smith & Nephew DYONICS® Motor Drive Units

For use with Smith & Nephew DYONICS POWER and EP-1® Control Units



7205357

Smith & Nephew DYONICS Mini-Motor Drive, suction lever,  
10 ft (3 m) cord

#### Disposable Mini Blades/Burrs





Used with the Smith & Nephew DYONICS® Power/EP-1® Mini Motor Drive (REF 7205357 pg. D-3).

Indications: Small joint arthroscopy. Packaged 6 per box, sterile

	Power/EP-1 REF	Description	Hub Color
	3606*	2.9 mm Cutter, 7 cm length	Beige
	3407*	2.0 mm TURBOWHISKER®, 7 cm length	Yellow
	3418	2.9 mm TURBOWHISKER®, 7 cm length	Green
	3410*	2.0 mm Full Radius, 7 cm length	Blue
	3419	2.9 mm Full Radius, 7 cm length	Red
	6900927	Blade, BONECUTTER®, FR, 3.5, DSPL	
	3553*	2.9 mm Barrel Abrader, 7 cm length	Purple
	3530*	2.9 mm Abrader, 7 cm length	Orange
	3819	3.5 mm Abrader, 7 cm length	Aqua
	4224*	3.5 mm RAZORCUT®, 7 cm length	Pink
	4225*	3.5 mm INCISOR®, 7 cm length	Turquoise
	7209065	2.9 mm INCISOR, 7 cm length	Lime green
	7209085	2.0 mm INCISOR, 7 cm length	Navy blue

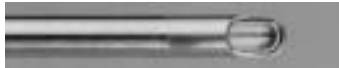
#### Disposable Mini Blades — Long and Curved

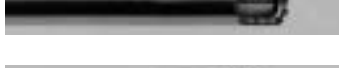
Indications: Small joint arthroscopy. Packaged 6 per box, sterile

	7205474*	3.5 mm Full Radius, 8 cm length	Plum
	7210488	3.5 mm Full Radius curved, concave	Forest green
	7205477	3.5 mm RAZORCUT®, 8 cm length	Pumpkin/orange
	7205558	3.5 mm curved, concave, INCISOR®, 8 cm length	Brick red
	7205476	3.5 mm INCISOR Plus, 8 cm length	Sage green

\*item shown

Call +1-800-343-5717 (U.S.) or contact your local representative.



## Visualization

### Small Joint Arthroscopes



REF	Focal Length	Outer Diameter	Direction of View	Field of View	Working Length	Light Post Direction	Cannula Connection	Recommended Light Cable
<b>Videarthroscope, Autoclavable 470 heads only:</b>								
7209402	35 mm	2.7 mm	30°	90°	120 mm	Opposite	J-Lock	4.0 mm
7205929	35 mm	2.7 mm	30°	90°	67 mm	Opposite	J-Lock	4.0 mm
<b>Videarthroscope, Non-autoclavable:</b>								
3632	35 mm	2.7 mm	30°	90°	120 mm	Opposite	J-Lock	4.0 mm
3768	35 mm	2.7 mm	30°	90°	67 mm	Opposite	J-Lock	4.0 mm
3863	35 mm	1.9 mm	30°	75°	65 mm	Opposite	J-Lock	2.0 mm
4130†*	25 mm	2.7 mm	30°	90°	120 mm	Opposite	J-Lock	4.0 mm
4131†	25 mm	2.7 mm	30°	90°	67 mm	Opposite	J-Lock	4.0 mm
4132†	25 mm	2.7 mm	70°	90°	70 mm	Opposite	J-Lock	4.0 mm
7208133†	25 mm	1.9 mm	30°	75°	62 mm	Opposite	J-Lock	2.0 mm
<b>Direct-View, Autoclavable:</b>								
7205682		2.7 mm	30°	90°	67 mm	Opposite	J-Lock	4.0 mm
7205681		2.7 mm	30°	80°	120 mm	Opposite	J-Lock	4.0 mm
<b>Direct-View, Non-autoclavable:</b>								
3625		2.7 mm	30°	90°	120 mm	Opposite	J-Lock	4.0 mm
3947		2.7 mm	30°	90°	67 mm	Opposite	J-Lock	4.0 mm

### Carpal Tunnel VideoEndoscope

REF	Description
4139Z*	Carpal Tunnel VideoEndoscope, 4 mm x 30°, 25 mm focal length



\* Made to order. Please contact your sales representative for more information.  
†HD Compatible

## Procedure Specific Solutions

### Triangular Fibrocartilage Complex

Smith & Nephew TFCC Mender Disposable Suture System



REF	Description
7210752	The TFCC Mender system is designed for repairing the TFCC under direct arthroscopic viewing.

## Procedure Specific Solutions

### Flexor Tendon Release – Trigger Finger System



In conjunction with Yasushi Nakao, M.D., Smith & Nephew has developed an endoscopic approach to “flexor tendon release” for fingers and thumbs due to stenosing tenosynovitis.

Our minimally invasive approach is designed to decrease patient discomfort while incorporating the maximum safety element of releasing the A1 pulley under direct endoscopic vision. The system and technique combine to minimize patient risk commonly associated with conventional open or blind percutaneous techniques.

#### Trigger Finger System

REF	Description
7207698	Trigger Finger System
System includes:	
7207689	Cannula, Operative, 29 mm, short window
3807	Obturator, Conical, 2.9 mm, short
7207741	Cannula, Operative, 2.9 mm, long window
7207721	Obturator, Conical, 2.9 mm, short
7207697	Curved Blunt Dissector
7207875	Probe, 2.2 mm
7207696	Trigger Finger Sterilization Tray, 9" x 10" x 3"

#### Single Use Accessories

7207690	Trigger Finger Retrograde Knife, yellow, sterile, (box of 6)
7207693	Trigger Finger Triangle Knife, pumpkin, sterile, (box of 6)
7207730	Cotton-Tipped Applicators, sterile, 20 packages of 5 each

## Procedure Specific Solutions

### Carpal Tunnel Ligament Repair – ECTRA® II Systems



#### ECTRA II System – 25 mm

The Smith & Nephew ECTRA II systems permit the surgeon to access and release the carpal tunnel ligament endoscopically, allowing access via two portals for distal and proximal cutting, while minimizing endoscopic lens fogging with good air flow. ECTRA II offers the surgeon complete visualization and control. ECTRA knives permit the surgeon to determine both the direction and depth of the cut.

Constant and complete visualization

Simple tools eliminate mechanical malfunctions

Also indicated for use in plantar fasciotomy and extra-articular lateral release

Defined channel limits the cutting zone and assists the surgeon in protecting neurovascular structures

Each system supplied with an instructional videotape

REF	Description
4119*	ECTRA II System, 25 mm
System includes:	
4139Z†	Carpal Tunnel VideoEndoscope, 25 mm
4120	Slotted Cannula
4101	Blunt Dissector, curved
3856	Probe
4283	Palmar Arch Suppressor
4450	Hand Holder and Sterilization Tray with Cover
4141	Hand Strap
4432	Detachable Obturator Handle
4433	Conical Obturator
4434	Boat Nose Obturator
4435	Dissecting Obturator
4452	Ragnell Retractor (2 included with system)

\* Item shown

† Made to Order item

## Procedure Specific Solutions

### Carpal Tunnel Ligament Repair – ECTRA<sup>®</sup> II Systems

#### ECTRA II System – 35 mm

REF	Description
4143	ECTRA II System, 35 mm
System includes:	
3896	Carpal Tunnel VideoEndoscope, 35 mm
4120	Slotted Cannula
4101	Blunt Dissector, curved
3856	Probe
4283	Palmar Arch Suppressor
4450	Hand Holder and Sterilization Tray with Cover
4141	Hand Strap
4432	Detachable Obturator Handle
4433	Conical Obturator
4434	Boat Nose Obturator
4435	Dissecting Obturator
4452	Ragnell Retractor (2 included with system)

#### ECTRA II System – Direct View

4149	ECTRA II System, Direct View
System includes:	
4144	Carpal Tunnel Endoscope
4120	Slotted Cannula
4101	Blunt Dissector, curved
3856	Probe
4283	Palmar Arch Suppressor
4450	Hand Holder and Sterilization Tray with Cover
4141	Hand Strap
4432	Detachable Obturator Handle
4433	Conical Obturator
4434	Boat Nose Obturator
4435	Dissecting Obturator
4452	Ragnell Retractor (2 included with system)

## Procedure Specific Solutions

### Carpal Tunnel Ligament Repair – ECTRA® II Systems

#### ECTRA II System without Endoscope

REF	Description
7204841	ECTRA II System without Endoscope
System includes:	
4120	Slotted Cannula
4101	Blunt Dissector, curved
3856	Probe
4283	Palmar Arch Suppressor
4450	Hand Holder and Sterilization Tray with Cover
4141	Hand Strap
4432	Detachable Obturator Handle
4433	Conical Obturator
4434	Boat Nose Obturator
4435	Dissecting Obturator
4452	Ragnell Retractor (2 included with system)

#### ECTRA II Obturator Set

4453 ECTRA II Obturator Set

Set includes:



4433 Conical Obturator



4434 Boat Nose Obturator



4435 Dissecting Obturator



4432 Detachable Obturator Handle

#### Other Components



3856 Probe, 3.0 mm



4101 Blunt Dissector, curved













4452 Ragnell Retractor

## Procedure Specific Solutions

### Carpal Tunnel Ligament Repair – ECTRA<sup>®</sup> II Systems

#### ECTRA II Obturator Set

REF	Description
4453	ECTRA II Obturator Set
	Set includes:
	4433 Conical Obturator
	4434 Boat Nose Obturator
	4435 Dissecting Obturator
	4432 Detachable Obturator Handle
<b>Other Components</b>	
	3856 Probe, 3.0 mm
	4101 Blunt Dissector, curved
	4452 Ragnell Retractor
	4120 Slotted Cannula
	4283 Palmar Arch Suppressor
	3896 Carpal Tunnel VideoEndoscope, 4 mm x 30°, 35 mm focal length
	4144 Carpal Tunnel Endoscope, 4 mm x 30°
	4450* Hand Holder and Sterilization Tray with Cover
	4141 Hand Strap

# Procedure Specific Solutions

## Carpal Tunnel Ligament Repair – ECTRA® II Systems

ECTRA II Disposable Kit



REF	Description
4116	ECTRA II Disposable Kit

Each kit includes:

8 Swabs, 3 Disposable Knives, 1 Hand Pad, sterile

### Disposable Knives

REF	Description
4448	Triangle Knife, green, sterile, (box of 6)
4447	Probe Knife, beige, sterile, (box of 6)
4449	Retrograde Knife, blue, sterile, (box of 6)



## ARTHROPAK<sup>®</sup>

### Customized Procedure Kit



#### ARTHROPAK Customized Procedure Kit

Smith & Nephew DYONICS<sup>®</sup> ARTHROPAK<sup>®</sup> Customized Procedure Kits provide increased operational efficiencies and reduced supply expense. You customize your kit with your selection of disposable Smith & Nephew products for any arthroscopic procedure at a reduced cost!

- Free customized service
- Reduced product cost
- Save valuable time and demand on staff
- Streamlined ordering process
- Increased standardization
- Reduced inventory

DYONICS ARTHROPAK Customized Procedure Kits reduce the number of SKUs that need to be ordered and aggregate purchasing volume of arthroscopic products by enabling purchase from a single supplier. Please ask your local sales representative to demonstrate how DYONICS ARTHROPAK Customized Procedure Kits can benefit your practice.

# K

- Hip Arthroscopy – Visualization.....K-1
- Smith & Nephew Hip Positioning Systems.K-2
  - Supine Hip Positioning System .....K-2
  - Lateral Hip Positioning System.....K-3
  - SPIDER Hip Positioning System.....K-4
- Hip Arthroscopy Set.....K-5
  - Cannulas, Obturators, and Irrigation  
Extenders.....K-5
- CROSSTRAC® Hip Guide System.....K-6
- Hip Arthroscopy Set – Hand Instruments  
and Accessories .....K-7
- Hip Arthroscopy – Resection Products.....K-8
- Hip Repair.....K-9
- ARTHROPAK® .....K-11
  - Customized Procedure Kit.....K-11

## Hip Arthroscopy

### Product Highlights

#### Hip Positioning Systems

Offers the greatest range of motion with a unique, patented ball joint that allows the hip to be easily flexed, abducted or adducted



Hip Positioning System - supine



Hip Positioning System - lateral

Hip Positioning Systems  
Page K-2 and K-3



#### BIORAPTOR® 2.3 Pk Suture Anchor

Achieve consistent placement using the new easy-to-use BIORAPTOR 2.3 Pk Suture Anchor

BIORAPTOR Suture Anchors  
Page K-8

## Hip Arthroscopy – Visualization

The Smith & Nephew Hip Arthroscopy system is compatible with standard length 30° and 70° 4.0 mm VideoArthroscopes. The sealed scope design, superior fluid management, and easy one handed light post rotation make Smith & Nephew VideoArthroscopes ideal for hip arthroscopy. Now, see more clearly than ever with the new Smith & Nephew 560 Series High Definition Camera System – offering unparalleled brightness, vivid color reproduction, and greater depth of field.

### VideoArthroscopes, Non-Autoclavable

REF	Outer Diameter	Direction of View	Field of View	Working Length	Light Post Direction	Cannula Connection	Recommended Light Cable
<i>VideoArthroscopes, Autoclavable, High Definition 560H only</i>							
72200312	4.0 mm	30°	115°	160 mm	Opposite	J-Lock	5.0 mm
72200089	4.0 mm	70°	115°	160 mm	Opposite	J-Lock	5.0 mm
7210716	4.0 mm	30°	115°	160 mm	Opposite	J-Lock	5.0 mm
7209401	4.0 mm	70°	115°	160 mm	Opposite	J-Lock	5.0 mm
72201501	4.0 mm	30°	115°	160 mm	Opposite	J-Lock	5.0 mm
72201671	4.0 mm	70°	115°	160 mm	Opposite	J-Lock	5.0 mm
7205922*	4.0 mm	30°	115°	160 mm	Opposite	J-Lock	5.0 mm
3628	4.0 mm	70°	115°	160 mm	Opposite	J-Lock	5.0 mm

### Extended Length VideoArthroscopes – Hip Arthroscopy, Non-HD

REF	Outer Diameter	Direction of View	Field of View	Working Length	Light Post Direction	Cannula Connection	Recommended Light Cable
7211054*	4.0 mm	30°	115°	218 mm	Opposite	J-Lock	4.0 mm
7211055*	4.0 mm	70°	115°	222 mm	Opposite	J-Lock	4.0 mm
72201597	4.0 mm	30°	115°	278 mm	Opposite	J-Lock	4.0 mm
72201598	4.0 mm	70°	115°	280 mm	Opposite	J-Lock	4.0 mm

\*Please note that these scopes provide an inverted image

### Diagnostic Cannulas, Extended Length

For use with hip arthroscopy scopes REF 7211054 and 7211055

REF	Description
7211094	6.0 mm diagnostic cannula, with InteliJET® inflow and valve, rotatable
7207913	6.0 mm diagnostic cannula, double valve, rotatable
7207898	4.5 mm cannulated obturator for cannulas 7211094 and 7207913

For use with hip arthroscopy scopes REF 72201597 and 72201598

REF	Description
72201816	6.0 mm diagnostic cannula, double valve, rotatable
72201898	4.5 mm cannulated obturator for cannula 72201816

## Smith & Nephew Hip Positioning Systems

### Supine Hip Positioning System

With the Smith & Nephew Hip Positioning System you can perform arthroscopy on most OR tables in either the lateral or supine position. This system allows a wide range of motion: it can be easily flexed, abducted or adducted – movements especially important for emerging arthroscopic techniques. Patient limit 6' 4", 400 lbs.



REF	Description
<b>Supine Hip Positioning System</b>	
72201724	Supine Hip Positioning System
Includes:	
72200626	Universal Hip Distractor with Boot
72200627	Knee Holder
72201725	Supine Table Extension, Table width extention: 20.5"–25.5" (500–640 mm)
72200631	Peroneal Post
72200632	Well Leg Holder with Boot

### Supine Accessories

72200637	Patient Transfer Board
72200669	Storage Cart
72200633	Replacement Boot (1)
72201540	Replacement Straps (3)

### Supine Rail Clamps

72200636	US Rail Clamps (2)	0.375" x 1.125" (1 cm x 2.9 cm)
72200670	Eur/UK Rail Clamps (2)	0.394" x 0.984" (1 cm x 2.6 cm) 0.250" x 1.50" (0.7 cm x 3.2 cm)
72200671	Denyer Rail Clamp (2)	0.345" x 1.26" (0.9 cm x 3.2 cm)
72200672	Japanese Rail Clamp (2)	0.394" x 1.181" (1 cm x 3 cm)
72200673	Swiss Rail Clamp (2)	

### Supine Single Use Disposables

72200634	Supine Peroneal Post Pad (1)
72200635	Boot Insert Pad (2)

## Smith & Nephew Hip Positioning Systems

### Lateral Hip Positioning System



REF	Description
<b>Lateral Hip Positioning System</b>	
72201636	Lateral Hip Positioning System
Includes:	
72200626	Universal Hip Distractor with Boot
72201364	Lateral Table Attachment with peroneal post pad, Table width extension 20.5" x 25.5" (500 mm x 640 mm)

#### Lateral Accessories

72200718	Replacement Lateral Peroneal Post Pad (1) (multi-use)
72200669	Storage Cart
72200633	Replacement Boot (1)
72201540	Replacement Straps (3)

#### Lateral Rail Clamps

72200643	US Rail Clamps (2)	0.375" x 1.125" (1 cm x 2.9 cm)
72200675	Eur/UK Rail Clamps (2)	0.394" x 0.984" (1 cm x 2.6 cm) 0.250" x 1.250" (1 cm x 2.6 cm)
72200676	Denyer Rail Clamp (2)	0.250" x 1.50" (1 cm x 2.9 cm)
72200677	Swiss Rail Clamp (2)	0.394" x 1.184" (1 cm x 3 cm)

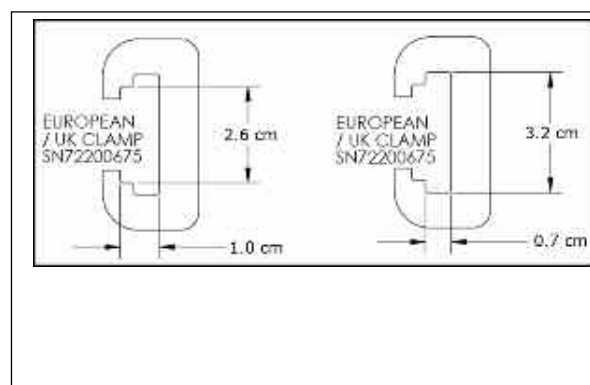

## Smith & Nephew Hip Positioning Systems

### SPIDER Hip Positioning System

Increase the flexibility of your fracture table with the SPIDER Hip Positioning System. Stable positioning and traction while offering increased range of motion for hip arthroscopy when using a fracture table.



REF	Description
-----	-------------

#### SPIDER Limb Positioner

7210569	SPIDER Limb Positioner
---------	------------------------

#### Supine Hip Positioning Components

7210569	SPIDER Limb Positioner
72201427	MAXI Traction Accessory
72201425	SPIDER Boot with Foam Insole

#### Supine Fracture Table Adapters\*\*

72202060	Maquet
72202061	OSI
72202062	Trumpf
72202063	AMSCO

#### Supine Semi-Disposables

72201426	Boot Liner (4)
72201429	Replacement Foam Insole (4)

\*\*These items must be ordered directly from TENET Medical Engineering: [info@tenetmedical.com](mailto:info@tenetmedical.com)

## Hip Arthroscopy Set

### Cannulas, Obturators, and Irrigation Extenders



ARTHROGARDE<sup>®</sup> Hip Access Cannulas are designed to be atraumatic, featuring smooth ends for optimal safety and high-strength design for enhanced durability.

The uniquely designed rounded ends provide a smooth surface to help protect soft tissue when performing hip arthroscopy. Plus, they're extra strong to prevent bending or wear and tear over time. Combine with our CROSSTRAC<sup>®</sup> Hip Guide System for accurate trajectories and first-time access to the hip joint.

REF	Description
<b>ARTHROGARDE Hip Access Cannulas</b>	
72201741	4.5 mm ARTHROGARDE Hip Access Cannula, green (CROSSTRAC Hub)
72201742	5.0 mm ARTHROGARDE Hip Access Cannula, blue (CROSSTRAC Hub)
72201743	5.5 mm ARTHROGARDE Hip Access Cannula, red
7209345	3.0 mm Cannula, Inflow

#### Arthroscopic Hip Set Instrumentation – Obturators

72200884	4.5 mm Obturator, Conical, green, used with REF 72201741
72200885	4.5 mm Obturator, Cannulated, green, used with REF 72201741
72200096	4.5 mm Obturator, Cannulated, green, large Delrin handle, used with REF 72201741
72200882	5.0 mm Obturator, Conical, blue, used with REF 72201742
72200883	5.0 mm Obturator, Cannulated, blue, used with REF 72201742
72200097	5.0 mm Obturator, Cannulated, blue, large Delrin handle, used with REF 72201742
72200880	5.5 mm Obturator, Conical, red, used with REF 72201743
72200881	5.5 mm Obturator, Cannulated, red, used with REF 72201743
72200098	5.5 mm Obturator, Cannulated, red, large Delrin handle, used with REF 72201743
7207751	5.5 mm Obturator, long, Cannulated, used with disposable Cannula REF 7205360
7210392	5.5 mm Obturator, Cannulated, used with slotted cannula REF 72201590
7209349	Obturator for 3.0 mm cannula
72201355	Reuseable Obturator for 5.7 mm Flexible Cannula
7207934	Hip Arthroscopy System Sterilization Tray (21" x 10" x 3.5")

#### Arthroscopic Hip Set Instrumentation – Irrigation Extenders

7209346	Irrigation Extender with Valve
7209347	Irrigation Extender with InteliJET <sup>®</sup> Inflow
7209348	Irrigation Extender with InteliJET Inflow and Valve
72200004	Irrigation Extender, rotatable, with InteliJET inflow
7210224	Irrigation Extender, rotatable, with InteliJET Inflow and Valve
72200083	Irrigation Extender, rotatable, double valve
72200084	Irrigation Extender, rotatable, single valve
72200615	Hip Fluid Seal Adaptor



## CROSSTRAC<sup>◇</sup> Hip Guide System



Accessing the hip joint has never been easier. With its unique triangulated design and needle point accuracy, the CROSSTRAC Hip Guide System allows for consistent trajectory alignment and portal placement where you want it. Use with our standard length 4 mm arthroscopes and our new atraumatic-in-design ARTHROGARDE<sup>◇</sup> Hip Access Cannulas for improved tissue protection and safety.

REF	Description
72201832	CROSSTRAC Hip Guide System
System Includes:	
72201831	CROSSTRAC Hip Guide with Bullet (1) <i>Includes:</i> 72201674 CROSSTRAC Hip Guide 72201727 CROSSTRAC Hip Guide Bullet
72201741	4.5 mm ARTHROGARDE Hip Access Cannula, green (CROSSTRAC Hub) (1)
72201742	5.0 mm ARTHROGARDE Hip Access Cannula, blue (CROSSTRAC Hub) (2)
72200096	4.5 mm Cannulated Obturator with Delrin Handle (1)
72200097	5.0 mm Cannulated Obturator with Delrin Handle (1)
Sold Separately:	
72201811	XL (extra-long) Disposable Arthroscopy Needle, 5pk



## Hip Arthroscopy Set – Hand Instruments and Accessories

REF	Description
<b>Arthroscopic Hip Set Instrumentation – Basket Punches, extended length</b>	
7207545	Rotary, 2.2 mm, left, loop handle
7207544	Rotary, 2.2 mm, right, loop handle
7207735	Scoop, 1.5 mm, Upbiter
7207736	DUCKLING°, Upbiter
7207737	DUCKLING°, Upswept
7207733	Narrowline Upbiter
7207734	Narrowline Upbiter, curved right
7210730	STINGRAY° Basket Punch, right, length extended by 2.25"
7210731	STINGRAY Basket Punch, left, length extended by 2.25"

### Arthroscopic Hip Set Instrumentation – Graspers, extended 2.25" length

7207699	Grasper, Alligator max
7207700	Grasper, Cupped, 3.4 mm
7207731	Grasper, PITBULL°
7207732	RAPTOR° Rongeur

### Arthroscopic Hip Set Instrumentation – Accessories

7207934	Hip Arthroscopy Sterilization Tray
6900221	3 mm Probe (will fit 4.5 mm cannula)
7209351	Cap, Inflow
3801	Switching Stick, 4.3 mm not cannulated (13" long)
6905019	4.5 mm Cannulated Switching Stick
7210758	Banana Blade Knife
72200026	Fluid Seal Adaptor

### Arthroscopic Hip Set Instrumentation – Single Use Accessories

7209874	Disposable Hip Pac (includes 3 guidewires and 2 arthroscopy needles)
7205395	Guidewire, Nitinol, 1.2 mm x 18" (45 cm), package of 3
7209350	Arthroscopy Needle, 17 gauge, 6"
7205360	5.7 mm flexible cannula, disposable, package of 6
72200027	Fluid seals, for use with 72200026, box of 25

## Hip Arthroscopy – Resection Products



Smith & Nephew DYONICS® EFLEX® RF probes can deflect up to 100°, enabling access into areas of the hip joint that are difficult to reach with conventional rigid probes. Tip deflection is actuated by an easy-to-pull trigger system, with an ergonomically designed handle and palm grip. EFLEX probes are also available with an integrated power cable, eliminating the need to purchase and re-sterilize separate cables.

REF	Description
-----	-------------

### Smith & Nephew DYONICS EFLEX Radiofrequency Probes

72200683	DYONICS EFLEX ABLATOR® Probe with integrated cable
72200682	DYONICS EFLEX LIGAMENT CHISEL® Probe with integrated cable
72200681	DYONICS EFLEX TAC-S Probe with integrated cable

### Smith & Nephew DYONICS POWER Shaver Blades, 18 cm working length

72200414	4.5 mm Long INCISOR® Plus ELITE®, package of 3
72200494	4.5 mm Long Curved INCISOR Plus ELITE, package of 3
7205335	4.5 mm Long Curved Full Radius Concave, package of 3
7205336	4.5 mm Long Curved Full Radius Convex, package of 3
7205341	4.5 mm Long Full Radius, package of 3
7205343	4.5 mm Long Incisor, package of 3
7210979	4.5 mm Long BONECUTTER®, package of 3
6900678	5.5 mm Long Full Radius, package of 3, made to order

### Smith & Nephew DYONICS POWER Shaver Burrs, 18 cm working length, partial hood.

72200080	4.0 mm Long ABRADER, package of 3
72200082	5.5 mm Long ABRADER, package of 3

## Hip Repair

Smith & Nephew has developed a complete repair system that includes the first suture anchors cleared for labral refixation specifically in the hip, CLEAR-TRAC<sup>®</sup> complete disposable hip cannulas, microfracture instruments and a complete tray of repair instruments.

REF	Description
<b>Suture Anchors</b>	
72201991	OSTEORAPTOR <sup>®</sup> 2.3 Suture Anchor with (1) #2 ULTRABRAID <sup>®</sup> Suture (White)
72201992	OSTEORAPTOR 2.3 Suture Anchor with (1) #2 ULTRABRAID Suture (Cobraid black)
72201993	OSTEORAPTOR 2.3 Suture Anchor with (1) #2 ULTRABRAID Suture (Cobraid blue)
72201824	2.6 mm Twist drill for 2.3 Suture Anchor
72201541	BIORAPTOR <sup>®</sup> 2.3 PK Suture Anchor with 1 #2 ULTRABRAID Suture (Co-Braid Blue)
72201542	BIORAPTOR 2.3 PK Suture Anchor with 1 #2 ULTRABRAID Suture (Co-Braid Black)
72201543	BIORAPTOR 2.3 PK Suture Anchor with 1 #2 ULTRABRAID Suture (White)
72201105	2.3 mm Inline Drill Guide, Fish Mouth
72201110	2.3 mm Inline Drill Guide, Spike tip
72201111	2.3 mm Inline Drill Guide, Crown tip
72201107	2.3 mm Inline Obturator, Cannulated
72201112	2.3 mm Inline Obturator, Trocar tip
72201108	2.6 mm Drill Bit for 2.3 Suture Anchor
72201106	2.3 mm Inline Obturator, non-Cannulated
72202165	OSTEORAPTOR 2.9 Hip Suture Anchor with 1 #2 ULTRABRAID Suture (White)
72201395	Inline Drill Bit
72201388	Inline Drill Guide, Spike tip
72201389	Inline Drill Guide, Fishmouth tip
72201390	Inline Drill Guide, Crown tip
72201391	Inline Drill Guide, Offset Fishmouth tip
72201392	Inline Obturator, Blunt tip
72201393	Inline Obturator, Cannulated
72201394	Inline Obturator, Trocar tip

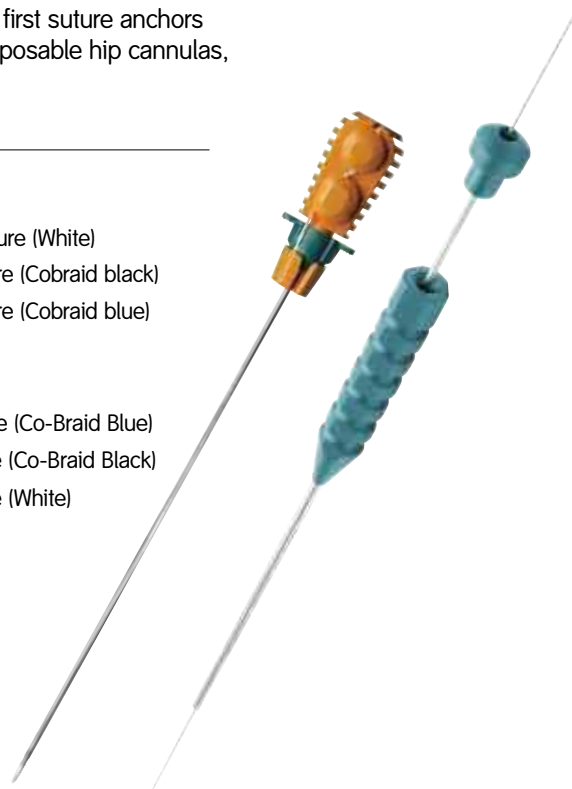

## Hip Repair

Cannula features all new, triple-seal system and integrated suture management.

REF	Description
<b>Disposable Repair Kit</b>	
72200803	Philippon Labral Repair Kit
Set Includes:	
72202165	(2) OSTEORAPTOR <sup>®</sup> 2.9 Hip Suture Anchor with (1) ULTRABRAID <sup>®</sup> #2 Suture
72200436	(1) CLEAR-TRAC <sup>®</sup> COMPLETE Hip Cannula 8.5 mm x 110 mm (box of 6)
72200082	(1) Extra length ABRADER burr

### CLEAR-TRAC COMPLETE Disposable Hip Cannula System

72200439	CLEAR-TRAC COMPLETE Hip Cannula 7.0 mm x 110 mm (box of 6)
72200436	CLEAR-TRAC COMPLETE Hip Cannula 8.5 mm x 110 mm (box of 6)
72200440	CLEAR-TRAC COMPLETE Hip Cannula 7.0 mm x 90 mm (box of 6)
72200437	CLEAR-TRAC COMPLETE Hip Cannula 8.5 mm x 90 mm (box of 6)
72200445	Reusable Obturator, 7.0 mm x 110 mm
72200442	Reusable Obturator, 8.5 mm x 110 mm
72200446	Reusable Obturator, 7.0 mm x 90 mm
72200619	Reusable Obturator, 8.5 mm x 90 mm
72201355	Reusable Obturator, 5.7 mm x disposable cannula, black handle
72200902	CLEAR-TRAC COMPLETE Threaded Cannula with disposable obturator, green, 8.5 mm x 90 mm (box of 10)
72200424	CLEAR-TRAC FLEXIBLE Threaded Cannula with disposable obturator, lime green, 8.0 mm x 90 mm (box of 10)
72200910	Reusable Obturator (4.3 mm connection), green, 8.5 mm x 90 mm for use with 72200902 cannula
72200913	Reusable Obturator (solid), green, 8.5 mm x 90 mm for use with 72200902 cannula
72200899	Reusable Obturator (4.3 mm connection), lime green, 8.0 mm x 90 mm for use with 72200424 cannula

### Microfracture

72202119	Microfracture Pick, 30°
72202120	Microfracture Pick, 45°
72202210	Microfracture Pick, 60°

### ELITE<sup>®</sup> Hip System

72200807	ELITE Hip System
Set Includes:	
7209496	ARTHROPIERCE <sup>®</sup> Instrument, straight
7209492	Sliding Suture Cutter
7209145	Crochet Hook
72201406*	12" Suture Passer, sterile, disposable
72200808	ELITE Hip System Sterilization Tray

\*Will need to be re-ordered as it is a disposable item

Call +1-800-343-5717 (U.S.) or contact your local representative.

## ARTHROPAK<sup>◇</sup>

### Customized Procedure Kit



#### ARTHROPAK Customized Procedure Kit

Smith & Nephew DYONICS<sup>®</sup> ARTHROPAK<sup>◇</sup> Customized Procedure Kits provide increased operational efficiencies and reduced supply expense. You customize your kit with your selection of disposable Smith & Nephew products for any arthroscopic procedure at a reduced cost!

- Free customized service
- Reduced product cost
- Save valuable time and demand on staff
- Streamlined ordering process
- Increased standardization
- Reduced inventory

DYONICS ARTHROPAK Customized Procedure Kits reduce the number of SKUs that need to be ordered and aggregate purchasing volume of arthroscopic products by enabling purchase from a single supplier. Please ask your local sales representative to demonstrate how DYONICS ARTHROPAK Customized Procedure Kits can benefit your practice.



## Laparoscopy

Laparoscopes .....	L-1
Endoscope & Laparoscope Accessories .....	L-2
Hysteroscopes/Cystourethroscopes and Hysteroscopic Sheaths .....	L-3
Made to Order .....	L-4
Laparoscopes .....	L-4

## Laparoscopes



Light post opposite direction of view

### Direct-View Autoclavable Laparoscopes

Stainless steel construction to withstand sterilization modalities (autoclave, EtO, Steris®, and Sterrad®)

Fully autoclavable, with both distal and proximal ends uniquely soldered for longevity

Autoclavable laparoscopes have sapphire distal lenses and rear ocular windows for much greater scratch resistance than conventional glass

Indications include thoracic surgeries

REF	Outer Diameter	Direction of View	Field of View	Working Length	Recommended Light Cable
7207944	10 mm	0°	84°	320 mm	5.0 mm
7207945	10 mm	30°	84°	320 mm	5.0 mm
7207946	10 mm	45°	84°	320 mm	5.0 mm
72202110	5.5 mm	0°	84°	290 mm	5.0 mm
72202111	5.5 mm	30°	84°	290 mm	5.0 mm
72202112	5.5 mm	45°	84°	290 mm	5.0 mm
7208333 <sup>†</sup>	5.0 mm	0°	84°	290 mm	4.0 mm
7208332 <sup>†</sup>	5.0 mm	30°	84°	290 mm	4.0 mm

<sup>†</sup>Indications include harvesting of superficial vessels of the lower extremities.

### Direct-View Autoclavable Bariatric Laparoscopes

Stainless steel construction to withstand sterilization modalities (autoclave, EtO, Steris®, and Sterrad®)

Fully autoclavable, with both distal and proximal ends uniquely soldered for longevity

Autoclavable laparoscopes have sapphire distal lenses and rear ocular windows for much greater scratch resistance than conventional glass

Indications include bariatric surgeries

REF	Outer Diameter	Direction of View	Field of View	Working Length	Recommended Light Cable
7211077	10 mm	30°	84°	450 mm	6.0 mm
7211078	10 mm	0°	84°	450 mm	6.0 mm
7211079	10 mm	45°	84°	450 mm	6.0 mm

## Laparoscopes

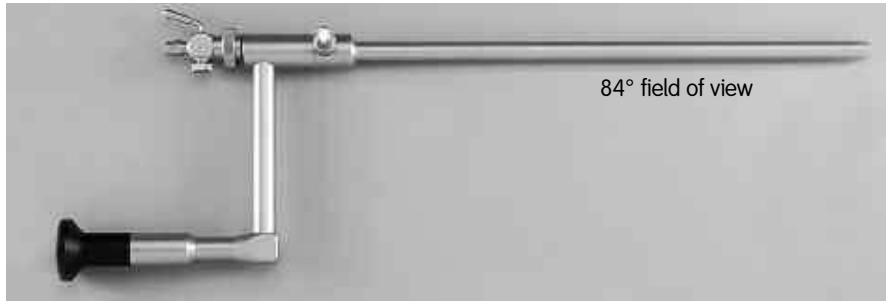

### Direct-View Operative Laparoscopes

Stainless steel construction to withstand sterilization modalities (EtO)

Wide angle of view

Indications include general and gynecological laparoscopic procedures

REF	Outer Diameter	Direction of View	Eyepiece Offset	Working Length	Operating Channel	Recommended Light Cable
7205549	10 mm	0°	90°	270 mm	5 mm	5.0 mm

## Endoscope & Laparoscope Accessories

### Accessories for Autoclavable Endoscopes

REF	Description
7205548	Aluminum oxide vial for cleaning autoclavable endoscope lenses
7210721	Protective cap for autoclavable scopes. Fits 4.0 mm and 5.5 mm scopes. Package of 70.

### Direct-View Operative Laparoscope Accessories

7205560	Replacement Stopcock, 45° offset
7205777	Replacement Stopcock, 90° offset
7205561	Replacement Seal Caps, box of 5



## Hysteroscopes/Cystourethroscopes and Hysteroscopic Sheaths



Light post opposite direction of view

Direct-View Autoclavable Hysteroscopes/Cystourethroscopes<sup>†</sup>  
 Light post opposite direction of view. Stainless steel construction to withstand sterilization modalities (Autoclave, EtO, Steris®, and Sterrad®)

REF	Outer Diameter	Direction of View	Field of View	Working Length	Sheath Style	Recommended Light Cable
7205463	4.0 mm	0°	101°	300 mm	Storz	4.0 mm,
7205465	4.0 mm	30°	101°	300 mm	Storz	4.0 mm,
7205462	4.0 mm	70°	101°	300 mm	Storz	4.0 mm,

<sup>†</sup> Indications for Use: Hysteroscopes and accessories (Operative Hysteroscopic Sheath) are used to permit viewing of the cervical canal and the uterine cavity for the purpose of performing diagnostic and surgical procedures. Cystourethroscopes are indicated for use in the examination of the bladder, urethra, and distal ureter, and, using additional accessories, to perform various diagnostic and therapeutic procedures.

### Hystereoscopic Sheaths

REF	Description
4512	5.0 mm Diagnostic Hystereoscopic Sheath, 15 Fr, single stopcock
7204513	7.0 mm Operative Hystereoscopic Sheath, 21 Fr, with one 2.9 mm working channel, double stopcocks

## Made to Order

### Laparoscopes

Made to Order products have longer production times. Please contact your sales representative or customer service for more information.

#### Direct-View Laparoscopes

Stainless steel construction to withstand sterilization modalities (EtO, Steris®, and Sterrad®)

Wide angle of view

Indications include thoracic surgeries

REF	Outer Diameter	Direction of View	Field of View	Working Length	Recommended Light Cable
7208328Z†	5.0 mm	30°	84°	290 mm	4.0 mm

†Indications include harvesting of superficial vessels of the lower extremities.

#### Direct-View Operative Laparoscopes

Stainless steel construction to withstand sterilization modalities (EtO)

Wide angle of view

Indications include general and gynecological laparoscopic procedures

REF	Outer Diameter	Direction of View	Eyepiece Offset	Working Length	Operating Channel	Recommended Light Cable
7205466	10 mm	0°	45°	270 mm	5.0 mm	5 mm

#### MicroLaparoscopes

Stainless steel construction to withstand sterilization modalities (EtO, Steris, and Sterrad)

Indications include general and gynecological laparoscopic procedures

REF	Outer Diameter	Direction of View	Field of View	Working Length	Recommended Light Cable
7208334Z	3.0 mm	0°	80°	277 mm	4.0 mm



## Illumination Equipment

Light Sources – Xenon Illuminators.....	M-1
Light Source Replacement Parts .....	M-2
Fiber Optic Light Cables and Adaptors .....	M-3
Compatibility Matrix .....	M-5

## Light Sources – Xenon Illuminators

Smith & Nephew DYONICS® Light Source provides bright white light for natural color reproduction. Features include a multi-port light cable receptacle for use with fiber optic light cables with DYONICS, Olympus®, Storz®, or ACMI® source ends.

### 300XL Xenon Light Source, 300W



REF	Description
7207407*	300XL System, English (U.S. power cord), 100-240 VAC
7207399	300XL System, Germany, 100-240 VAC
7207401	300XL System, France, 100-240 VAC
7207402	300XL System, Italy, 100-240 VAC
7207400	300XL System, Spain, 100-240 VAC
7207403	300XL System, Swedish, 100-240 VAC
7207404	300XL System, Dutch, 100-240 VAC
7207405	300XL System, English (U.K. power cord), 100-240 VAC
7207406	300XL System, English (Continental power cord), 100-240 VAC

### CONDOR®-Enabled 300XL Xenon Light Source, 300W









Adds CONDOR compatibility to the Smith & Nephew 300XL light sources.

7210261	300XL CONDOR-Enabled Light Source, English (U.S. power cord)
7210263	300XL CONDOR-Enabled Light Source, English (U.K. power cord)
7210265	300XL CONDOR-Enabled Light Source, International System

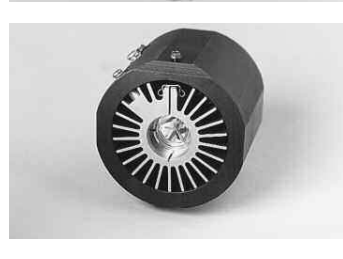
\* Item shown

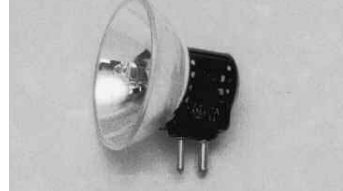
## Light Source Replacement Parts

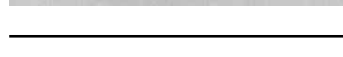
### Replacement Lamps

	REF	Description
	7207398*	Replacement Xenon Lamp Module, 300W, for 300XL Xenon Light Source, 500-hour minimum life
	72200529*	Replacement Xenon Lamp Module, 180W, for 420XL Light Source (72200510)
	7205351	Replacement Xenon XL Lamp Module, 180W, for Xenon Light Source, 500-hour minimum life
	7204741*	Replacement Xenon Lamp Module, 100W, for Xenon Light Source, 500-hour minimum life
	4248*	Replacement Xenon Lamp Assembly for DYOBRITE® 3000 Light Source (REF 4243)
	2974*	Replacement Metal Halide Arc Lamp with bracket, 250W for AutoBrite, MicroBrite, or ABI II II Illuminators, 250-hour life
	4550	Replacement Arc Lamp High-Voltage Cable Assembly for AutoBrite Illuminator II
	7204563*	Replacement Lamp for DYOSITE® II, 150 W, 100-hour life
	7209213	Replacement Lamp for DV 111, 60 W, 500-hour life

\* Item shown

Call +1-800-343-5717 (U.S.) or contact your local representative.

## Fiber Optic Light Cables and Adaptors

### Gemini® Universal 4 mm Fiber Optic Light Cables without Adaptor

For use with Smith & Nephew 4 mm and 2.7 mm arthroscopes.



REF	Description
2985*	4.0 mm x 8 ft
7205180	4.0 mm x 10 ft
7205179	4.0 mm x 12 ft

Use only REF 2146 and REF 2147 Versitip Adaptors for connection to Smith & Nephew Light Sources and endoscopes.

### Gemini® Universal 5 mm Fiber Optic Light Cables without Adaptor

For use with all arthroscopes and laparoscopes.

REF	Description
2140	5.0 mm x 8 ft
7205178	5.0 mm x 10 ft
7205177	5.0 mm x 12 ft

Use only REF 2146 and REF 2147 Versitip Adaptors for connection to Smith & Nephew Light Sources and endoscopes.

### Gemini® Universal Fiber Optic Light Cables with Adaptors

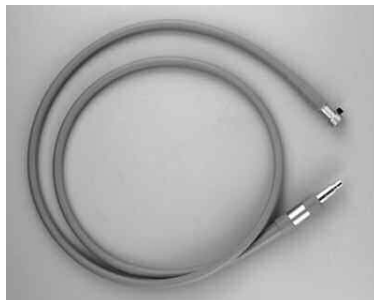

REF	Description
7208329	6.0 mm x 10 ft, with permanently fixed Smith & Nephew/Wolf® source and instrument end adaptors. For use with all 10 mm laparoscopes. Not for use with arthroscopes or 5.0 mm laparoscopes.



3004	2.0 mm x 8 ft, with Smith & Nephew/Wolf adaptors. For use with 1.9 mm arthroscopes (with REF 2147 in package).
------	--

\* Item shown

## Fiber Optic Light Cables and Adaptors

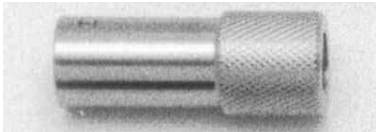
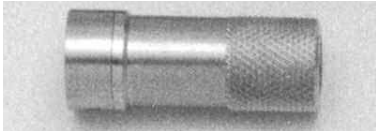
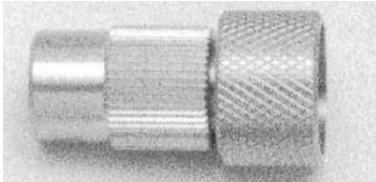

### Versitip Adaptors – Instrument End

For Smith & Nephew Gemini® Universal Fiber Optic Light Cables.

	REF	Description
	2141	ACMI® Instrument ("AI") Versitip Adaptor for 4.0 mm and 5.0 mm light guides Intended to interface Smith & Nephew Gemini Universal Fiber Optic Light Cables with ACMI endoscopes.
	2146	Smith & Nephew/Wolf® Instrument ("WI") Versitip Adaptor Intended to interface Smith & Nephew Gemini Universal Fiber Optic Light Cables with Wolf and Smith & Nephew endoscopes.
	2143	Storz®/Olympus® Instrument ("SI") Versitip Adaptor Intended to interface Smith & Nephew Gemini Universal Fiber Optic Light Cables with Storz or Olympus endoscopes.

### Versitip Adaptors – Light Source End

For Smith & Nephew Gemini Universal Fiber Optic Light Cables.

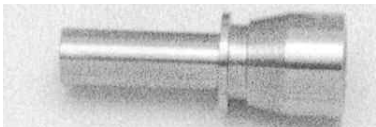
	2142	ACMI Source ("AS") Versitip Adaptor Intended to interface Smith & Nephew Gemini Universal Fiber Optic Light Cables with ACMI Light Sources. Not for use with Smith & Nephew light sources.
	2147	Smith & Nephew/Wolf Source ("WS") Versitip Adaptor Intended to interface Smith & Nephew Gemini Universal Fiber Optic Light Cable with Smith & Nephew or Wolf light sources.
	2145	Olympus Source ("OS") Versitip Adaptor Intended to interface Smith & Nephew Gemini Universal Fiber Optic Light Cable with Olympus light sources. Not for use with Smith & Nephew light sources.
	2144	Storz Source ("SS") Versitip Adaptor Intended to interface Smith & Nephew Gemini Universal Fiber Optic Light Cable with Storz light sources. For use with Smith & Nephew 420XL Light Source.

## Compatibility Matrix

To connect a Smith & Nephew light guide to a Smith & Nephew light source:

Smith & Nephew Light Guide	Smith & Nephew Versitip Adaptor Light Source End	Light Source Vendor	Connect to Light Source Input Port labeled:
7208329	NONE	Smith & Nephew	Wolf®/Smith & Nephew
3004	2147	↓	↓
2985	2147		
7205180			
7205178			
7205179			
7205177			

To connect a Smith & Nephew light guide to another vendor's light source:

Smith & Nephew Light Guide	Smith & Nephew Versitip Adaptor Light Source End	Light Source Vendor	
2985	2142	ACMI®	
2140	2147	Wolf	
7205180	2145	Olympus®	
7205178	2144	Storz®	
7205179	↓	↓	
7205177			

To connect another vendor's light guide to a Smith & Nephew light source:

Light Guide Vendor	Smith & Nephew Versitip Adaptor Light Source End	Light Source Vendor	Connect to Light Source Input Port labeled:
ACMI	NONE	Smith & Nephew	ACMI
Wolf	Insert in corresponding receptacle on front panel	↓	Wolf/Smith & Nephew
Olympus	labeled with vendor's name,		Olympus
Storz			Storz





Smith & Nephew 560P Camera  
Control Units.....N-1

Smith & Nephew 450P/460P  
Camera Control Units .....N-2

Smith & Nephew 470H Progressive  
Scan Autoclavable Camera Head .....N-3

## Surgical Video

### Product Highlights

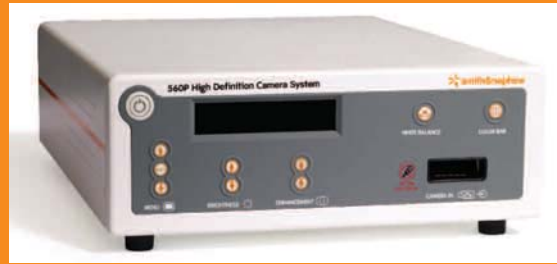

**560P HD Camera Control Unit**  
Providing exceptional versatility for  
endoscopic procedures in all OR settings.

## Smith & Nephew 560P Camera Control Units



### Smith & Nephew 560P Camera Control Unit

Smith & Nephew's 560P Camera Control Unit (CCU) provides exceptional high definition image quality, broadcast quality color reproduction, and versatility for all endoscopic procedures in the OR setting. This new generation of high definition CCU will meet or exceed your facility's multi-specialty needs. Compatible with the latest in digital technology with full 1080 output in DVI, HD-SDI, and YPrPb with a powerful user menu for customization.

REF	Description
	Complete system includes: 560P Camera Control Unit; power cord; SDI/HDTV Cable, RG-59, 10', and country specific manual
72200571	560P Camera Control Unit, NTSC/PAL, U.S. power cord, 100-240 VAC, 50/60 Hz
72200572	560P Camera Control Unit, NTSC/PAL, Spain, 100-240 VAC, 50/60 Hz
72200573	560P Camera Control Unit, NTSC/PAL, France, 100-240 VAC, 50/60 Hz
72200574	560P Camera Control Unit, NTSC/PAL, Germany, 100-240 VAC, 50/60 Hz
72200575	560P Camera Control Unit, NTSC/PAL, Italy, 100-240 VAC, 50/60 Hz
72200576	560P Camera Control Unit, NTSC/PAL, Sweden, 100-240 VAC, 50/60 Hz
72200577	560P Camera Control Unit, NTSC/PAL, Dutch, 100-240 VAC, 50/60 Hz
72200578	560P Camera Control Unit, NTSC/PAL, U.K., 100-240 VAC, 50/60 Hz
72200579	560P Camera Control Unit, NTSC/PAL, International, 100-240 VAC, 50/60 Hz
72201380	560P Camera Control Unit, NTSC/PAL, Korea, 100-240 VAC, 50/60 Hz
72201381	560P Camera Control Unit, NTSC/PAL, Portugal, 100-240 VAC, 50/60 Hz
72201382	560P Camera Control Unit, NTSC/PAL, Norwegian, 100-240 VAC, 50/60 Hz
72201383	560P Camera Control Unit, NTSC/PAL, Danish, 100-240 VAC, 50/60 Hz

### Smith & Nephew 560H Non-autoclavable Camera Head



Smith & Nephew's 560H broadcast high definition camera head is compatible with a complete line of Smith & Nephew direct-view endoscope, HD videoarthroscopes, monitors, and 560P HD Camera Control Unit. Provides for 3 buttons (6 function) control of CCU, peripheral devices, printers and Smith & Nephew Image Management Systems.

REF	Description
72200561	560H Camera Head, HD, NTSC/PAL

## Smith & Nephew 450P/460P Camera Control Units



### Smith & Nephew 450P/460P Camera Control Units

Smith & Nephew's 450P and 460P Camera Control Units (CCUs) provide exceptional versatility for endoscopic procedures in all OR settings. This new generation of CCUs will meet your facility's multi-specialty needs by providing procedure-specific image optimization as well as support for both autoclavable and non-autoclavable solutions. Compatibility with progressive scan camera heads and support for future software upgrades help ensure your investment remains secure and up-to-date.

In addition, the 460P CCU includes the latest in digital technology for state-of-the-art image fidelity and communications, including a complete set of digital video outputs (DVI, SDI, and DV) and digital zoom capability.

REF	Description
Complete system includes: Camera Control Unit; power cord; 1 6-pin-to-6-pin, 15 ft IEEE-1394 interconnected cable (REF 8109734) (460P only); 1 RGB cable (REF 130-0068); 1 S-video Cable (REF 130-0053); country specific manual	
72200085	450P Camera Control Unit, NTSC, U.S. power cord, 120 VAC
72200086	460P Camera Control Unit, NTSC, U.S. power cord, 120 VAC
72200103	450P Camera Control Unit, PAL, U.K. power cord, 230 VAC
72200104	460P Camera Control Unit, PAL, U.K. power cord, 230 VAC
72200105	450P Camera Control Unit, PAL, International power cord, 230 VAC
72200106	460P Camera Control Unit, PAL, International power cord, 230 VAC

### Smith & Nephew 460H Non-autoclavable Camera Head

Smith & Nephew 460H camera heads are compatible with a complete line of Smith & Nephew direct-view endoscopes, VideoEndoscopes (C-Mount), monitors, and camera control units. Three buttons allow remote control of compatible peripheral devices like the CCUs, printers, and Smith & Nephew Image Management Systems.

The Smith & Nephew 460H digital 3 CCD camera head is engineered to be a plug and play imaging solution and to maximize hospital efficiency. From the very creation of the image to the surgical environment, new technology in the 460H camera head successfully delivers all the aspects of a high quality surgical image for every endoscopic procedure.



REF	Description
72200090	460H Digital Camera Head, NTSC
72200091	460H Digital Camera Head, PAL

## Smith & Nephew 470H Progressive Scan Autoclavable Camera Head



### Smith & Nephew 470H Progressive Scan Autoclavable Camera Head

Smith & Nephew 470H camera heads are compatible with a complete line of Smith & Nephew direct-view endoscopes, VideoArthroscopes, monitors, and camera control units. Three buttons allow remote control of compatible peripheral devices like the CCUs, printers, and Smith & Nephew Image Management Systems.

The Smith & Nephew 470H Autoclavable 3 CCD camera head is engineered to be a plug and play imaging solution and to maximize hospital efficiency. The 470H head delivers exceptional image quality in an extremely durable and ergonomic package built to withstand the intense environment of the autoclave.

REF	Description
72200092	470H Autoclavable Camera Head, NTSC
72200093	470H Autoclavable Camera Head, PAL

### Replacement Parts

81010558	Replacement kit (soak cap, radial and crush seal O-rings, and lanyard)
8109222	O Rings
8109223	O Rings

# O

- Video Image Capture Devices.....O-1
- Video Monitors.....O-2
- Video Printers and Recorders.....O-3
- Video Printer Paper/Printer Accessories....O-4
- Video Couplers and Adaptors.....O-5
- Video and Accessory Cables.....O-7
- Video Carts and Accessories.....O-8
- Made to Order.....O-9

## Video Accessories



### 660HD Image Management System

Image management increases OR efficiency by easily capturing and utilizing surgical images in true high definition (HD) format.

## Video Image Capture Devices

### 660HD Image Management System

The Smith & Nephew 660HD Image Management System is an easy-to-use digital capture system that enables the OR staff to capture, edit, print, and store intraoperative surgical images and videos in true 1920 x 1080 high definition (HD) format.



### CONDOR-Enabled 660HD Image Management System

REF	Description
72200812	660HD Image Management System, English on-screen display and Operations/Service Manual, U.S. power cord
72200814	660HD Image Management System, multi-language on-screen display and Operations/Service Manual, continental power cord
72200816	660HD Image Management System, English on-screen display and Operations/Service Manual, U.K. power cord

### Accessories

7210344	Touch panel, LCD, 15" (domestic)
7210345	Touch panel, LCD, 19" (domestic)
7209339	Single-pedal footswitch
7209340	Dual-pedal footswitch
7210534	DVD-R media
7209338	650 MB or 700 MB CD-R media
72201464	Printer HP7460
7210533	Premium photo paper, high-gloss, 50 sheets
72201745	Premium photo paper, soft-gloss, 100 sheets
72200204	HP 99 Photo Inkjet Print Cartridge with Vivera Ink
72200205	HP 97 Tri-color Inkjet Print Cartridge, high volume

## Video Monitors



Smith & Nephew flat panel displays are optimized for use with the full range of Smith & Nephew video cameras and are part of the recommended Smith & Nephew visualization system configurations. These flat panel displays offer exceptionally clean, crisp, high-resolution images, ensuring superior reproduction of anatomical detail. Full HD widescreen displays deliver the full resolution of the Smith & Nephew 560 HD camera, 1920x1080i. HD compatible displays can display images from standard definition video sources but have lower than HD resolution.

### HD Widescreen, 16:9, Flat Panel Displays

REF	Description
72201421	24" HD Widescreen HD 1080i LCD
72201422	24" HD Widescreen HD 1080i LCD, UK
72201423	24" HD Widescreen HD 1080i LCD, International

### HD Compatible Flat Panel Displays

REF	Description
72201434	19" HD Compatible 5:4 square LCD
72201435	19" HD Compatible 5:4 square LCD, UK
72201436	19" HD Compatible 5:4 square LCD, International
72201085	32" HD Compatible Widescreen HD LCD
72201086	32" HD Compatible Widescreen HD LCD, UK
72201087	32" HD Compatible Widescreen HD LCD, International

### Desktop Monitor Stand

REF	Description
72200019	Desktop Monitor Stand for LCDs below 25 inches, Sony® SU-560

## Video Printers and Recorders

### Video Printers and Recorders

REF	Description
72200992	UP-55MD A5 Color Video Printer by Sony®, NTSC/PAL, RGB, S-VHS, composite video, compatible with Smith & Nephew digital camera head control buttons, medical grade, 8MB memory, 100–240 VAC
72201464	Plain paper printer. Up to 6 pages per minute in normal color mode. 30 pages per minute in draft color mode. Optional high-capacity ink cartridges so fewer cartridge changes are needed. 16 mb memory. Up to 4800-optimized dpi for professional photo quality. Advanced control panel with ink status display, and print quality selector.
7210817	Medical Grade DVD Video Recorder by Panasonic®. Real-time recording to digital video-in-video format, DVD-R, DVD-RAM compatible, controllable using a single-pedal footswitch or CCU accessory inputs, can create DVDs that play on commercial DVD players or PCs.



## Video Printer Paper/Printer Accessories

### Video Printer Paper

REF	Description
72200993	Color printing pack for Sony® UP-55MD printer (REF 72200992), 1 pack includes 2 bags of printer paper (100 each) and 2 color ribbon refills.
7207802	Sony® part # UPC-510, color printing pack for Sony® UP-51MD/MDU series printers (Smith & Nephew REF 7207801); 1 pack includes 2 bags of print paper (100 each) and ink ribbon; 200 prints per pack
7204983	Sony® part # UPC-5510, color printing pack for Sony® UP-5600MD series printers (Smith & Nephew REF 7204973); 1 pack includes 2 bags of print paper (100 each) and ink ribbon; 200 prints per pack
7206058	Sony® part # UPC-5510C, color printing pack for Sony® UP-5600MD series printers (Smith & Nephew REF 7204973); 1 pack includes 2 bags of print paper (100 each) and 1 <b>disposable</b> ribbon-loaded cartridge; 200 prints per pack
7206097	Sony® part # UPC-2010, color printing pack for Sony® UP-2900MD series printers (Smith & Nephew REF 7206094); 1 pack includes print paper and ribbon; 200 prints per pack
4249	Video Print Papers/Ink Cartridge for Toshiba printer (Smith & Nephew REF 7204253); 100 prints
3698	Sony® part # UPC-5010A, Video Print Papers/Ink Cartridge for Sony® UP-5000 series printers (Smith & Nephew REF 3758, 4238, and 4259); 100 prints
4217	Sony® part # UPC-3010 Video Print Papers/Ink Cartridge for Sony® 3000 series printers (Smith & Nephew REF 4150); 80 prints
7205206	Sony® part # UPC-1010 Video Print Papers/Ink Cartridge for Sony® 1800 series printers (Smith & Nephew REF 7204998); 100 prints
7204994	Replacement ribbon holder for Sony® UP-5600 series printers (Smith & Nephew REF 7204973)

Smith & Nephew, Inc. is a recognized Sony® distributor. All Sony® products not shown in this catalog are available upon request.

### Printer Accessories

7210533	HP Premium Plus High Gloss Photo Paper, 8.5" x 11", 50 sheets per package, for use with REF 72200035
72200204	HP High Volume Ink Cartridge, black 21 ml, for use with REF 72200035
72200205	HP High Volume Ink Cartridge, color 14 ml, for use with REF 72200035
72101745	HP Premium Plus Soft-gloss Photo Paper, 8.5" x 11", 50 sheets per package, for use with REF 72200426

## Video Couplers and Adaptors

### Non-Autoclavable Endocouplers

Superior clarity and brightness

Optimal picture quality

Ease-of-use: convenient one-finger scope attachment

Long-term reliability

Universal application: couplers fit rigid eyepiece endoscopes to V- or C-Mount camera heads of virtually any make or model

Compatible with EtO, Steris®, and Sterrad® sterilization modalities



#### REF

#### Description

72201635

Coupler, High Definition, Non-autoclavable, 19.5 mm, Black ring

72201730

Coupler, High Definition, Non-autoclavable, 26.0mm, Silver ring



#### REF

#### Description

7204613

C-Mount, 25 mm Coupler (black focus ring)

7204823\*

C-Mount, 30 mm Coupler (gold focus ring)

7204614

C-Mount, 35 mm Coupler (blue focus ring)



7205461

C-Mount Zoom Coupler, 25-45 mm, for use with Smith & Nephew Digital 3-Chip Camera Models D3, ED-3, and HD 460H



4533

C-Mount, 35 mm, 90° Urology Coupler, free-floating (lockable), rotating head



4464

C-Mount, 25 mm Beamsplitter, free-floating (lockable), rotating head

### Replacement Parts

#### REF

#### Description

8001701

Replacement O-ring for Videoscopes and C-Mount coupler

8012760

Replacement O-ring for V-Mount coupler

\* Item shown

## Video Couplers and Adaptors

### Autoclavable Couplers

Superior clarity and brightness

Thread compatible with Smith & Nephew autoclavable camera offering

Unparalleled brightness

Sharp images throughout the entire field-of-view

Sapphire lenses for improved scratch resistance over conventional glass

Epoxy-free, proprietary seal design guarantees leak-free autoclave performance

Compatible with steam and chemical (EtO, Steris®, and Sterrad®) sterilization modalities



### High Definition Endocouplers – 560H head only

REF	Description
72200315	19.5 mm High Definition, C-mount, Black ring
72200422	26.5 mm High Definition, C-mount, Silver ring



### Standard Definition Endocouplers

REF	Description
7210192	18 mm Smith & Nephew mount for use with 370 and 470H Camera Heads only

## Video and Accessory Cables

### Video and Accessory Cables

REF	Description
7206083	Accessory Control Cable, mini-phono to mini-phono, for use with 325Z, ED-3, and HD900 Video Cameras for remote connection with Video Printers (Smith & Nephew REF 7207812 and 7206094), Video Cassette Recorder, and Smith & Nephew 600-series Image Management System
4154	Accessory Control Cable, RCA to mini-phono, 6 ft., for use with D3, D1, and MiniCam Video Cameras for remote connection with Video Printers (Smith & Nephew REF 7207801, 7207812, and 7206094), Video Cassette Recorder (REF 7205010), and Smith & Nephew 600-series Image Management System
7211032	Cable Remote Adaptor to enable control of the DVD Video Recorder (7210817) with a single-pedal footswitch or CCU accessory outputs.
4175	RGB Cable, 6 ft (1.8 m)
4174	RGB Cable, 25 ft (7.6 m)
7209718	RGB Cable, 50 ft (15.2 m)
7209719	RGB Cable, 75 ft (22.8 m)
7210114	RGB Cable with single connector for flat panel displays, 6 ft (1.8 m).
7204585	DB9 to DB25 RS232 Data Cable, for use with Smith & Nephew Digital Camera Control Unit and Video Print Recorders (REF 7204253, 4259, 4238, 4251)
72201420	SDI/HDTV Cable, RG-59, BNC, 10'
72201438	SDI/HDTV Cable, RG-59, BNC, 25'
7209709	High-Grade S-VHS (S-video) Cable, 1.5 ft (46 cm)
7204580	High-Grade S-VHS (S-video) Cable, 6 ft (1.8 m)
7204582	High-Grade S-VHS (S-video) Cable, 15 ft (4.5 m)
7204583	High-Grade S-VHS (S-video) Cable, 25 ft (7.6 m)
7204584	High-Grade S-VHS (S-video) Cable, 50 ft (15.2 m)
7209710	High-Grade S-VHS (S-video) Cable, 75 ft (22.8 m)
7205002	DB9-RCA Remote Cable
7205196	Talley Cable for Sony® SVO-2000
7204586	RCA to Mini Cable
7209761	S-USB Cable, 50 ft (15.2 m)
7209762	S-USB Cable, 75 ft (22.8 m)
7209775	S-USB Cable, 3 ft (.92 m)
7209836	S-USB Cable, 10 ft (3 m)
7209848	Audio Hook-Up Cable, 1/8" phono to 1/8" phono, 50 ft (15.2 m)
7209849	Audio Hook-Up Cable, 1/8" phono to 1/8" phono, 75 ft (22.8 m)
7209850	Audio Hook-Up Cable, 1/8" stereo phono to 1/8" stereo phono, 50 ft (15.2 m)
7209851	Audio Hook-Up Cable, 1/8" stereo phono to 1/8" stereo phono, 75 ft (22.8 m)
7209852	Audio Hook-Up Cable, 1/8" stereo phono male to 1/8" stereo phono female, 50 ft (15.2 m)
7209853	Audio Hook-Up Cable, 1/8" stereo phono male to 1/8" stereo phono female, 75 ft (22.8 m)
7209856	Audio Hook-Up Cable, 1/8" phono to 1/8" phono, 1.5 ft (46 cm)

## Video Carts and Accessories



### Endoscopy Base Carts

REF	Description
72202161	Cross Specialty Cart with LCD Video Boom
72202162	Cross Specialty Cart with LCD Video Boom and Transformer
72202163	Cross Specialty Cart with LCD Post-Mount
72202164	Cross Specialty Cart with LCD Post-Mount and Transformer

## Made to Order

Made to Order products have longer production times. Please contact your sales representative or customer service for more information.

### Urology Coupler



REF	Description
7209042	C-Mount, 25 mm, 90° Urology Coupler, free-floating (lockable), rotating head, for 4.0 mm and 5.0 mm endoscopes

# P

## Sterilization Trays and Miscellaneous

Storage and Sterilization Trays .....	P-1
Storage and Sterilization Trays/Personal Protection Items .....	P-4
Fracture Support Table .....	P-5
Made to Order .....	P-6

Smith & Nephew sterilization trays are not validated for Sterrad® or Steris® sterilization modalities.

## Storage and Sterilization Trays

### For Hand-Held Instruments

REF	Description
011673	Linear Instrument Sterilization Tray, holds 15 instruments (10"L x 9"W x 4.5"H)
011694	Arthroplasty Instruments Seven-Unit Sterilization Tray (8.88"L x 8.63"W x .75"H)
011695	Rotary instrument sterilization tray, holds four (4) instruments (10.25"L x 6.5"W x .75"H)
7207161	Smith & Nephew ACUFEX <sup>®</sup> Pro Seven-Unit Sterilization Tray, for Smith & Nephew ACUFEX Pro, ProLine, or Smith & Nephew ACUFEX Hand-Held Instruments (10"L x 6"W x 5"H)
7207162	Smith & Nephew ACUFEX Pro Fifteen-Unit Sterilization Tray, for Smith & Nephew ACUFEX Pro, ProLine, or Smith & Nephew ACUFEX Hand-Held Instruments (12"L x 10"W x 5"H)
7209334	25-unit Sterilization Tray, metal – MTO

**NOTE:** Sterilization Trays only sold as a unit. Top and Bottom not available separate.

### For Cruciate Reconstruction

011802	TRE-CORE <sup>®</sup> Bone Cutting Guide System (18"L x 8"W x 2"H)
014870	ACL REDUX <sup>®</sup> Revision System (21"L x 10"W x 2"H)
7207182	GRAFTMASTER <sup>®</sup> II Graft Preparation System (18"L x 8"W x 2.5"H)
7207232	Smith & Nephew ACUFEX Director Endoscopic ACL Drill Guide System (20"L x 9"W x 4"H)
7207233	Smith & Nephew ACUFEX Director RCI Drill Guide System (20"L x 9"W x 4"H)
7207234	Smith & Nephew ACUFEX Director Rear-Entry ACL Drill Guide System (20"L x 9"W x 4"H)
7207357	Large Sterilization Tray for Smith & Nephew ACUFEX Director PCL Drill Guide System, large (14"L x 9"W x 1.5"H)

### For Meniscal Repair

011702	Meniscal Stitcher (10.37"L x 8"W x 1"H)
7207357	Large Sterilization Tray with mat (13"L x 8"W x 1.25"H) for use with the Meniscus Mender II System

### For Fixation Systems

011804	Fixation Post Instrument System (9"L x 9"W x 1.5"H)
7205514	SOFTSILK <sup>®</sup> 1.5 Screw System (15"L x 10"W x 2"H)
7207196	SOFTSILK 2.0 Screw System (14"L x 9"W x 1.5"H)
7207169	RCI Screw System
7207369	Sterilization Tray for ENDO-FIX <sup>®</sup> L Delivery System
014894	Sterilization Tray for ENDO-FIX Delivery System

### For Osteochondral Grafting

7205507	MOSAICPLASTY <sup>®</sup> Complete System (19"L x 9"W x 2"H)
7205604	MOSAICPLASTY Precision System (19"L x 9"W x 2"H)



## Storage and Sterilization Trays

### For Shoulder Reconstruction

REF	Description
011603	TAG° Instrument System (open procedure), (11.25"L x 9"W x .75"H)
011632	SURETAC° Instrument Tray (15"L x 8"W x 1"H)
011633	Shoulder Accessory Kit (18"L x 8"W x 2"H)
014628	SURETAC IXC Instrument Tray (18"L x 8"W x 1"H)
014712	TAG Arthroscopic Delivery System (18"L x 8"W x 1"H)
7207114	Portal Accessory System (18"L x 8.5"W x 1"H)
7209137	ELITE° Instrument Sterilization Tray (20.5"L x 9.63"W x 3.5"D, total depth with lid)
7209182	ARTHRO-PIERCE° Sterilization Tray (13"L x 9"W x 6"H)

### For Small Joints

014629	MINI-TAG° Instrument System (10"L x 3.75"W x 1"H)
7207032	Guhl System Non-Invasive Ankle Distractor (18.5"L x 8.5"W x 2"H)
7207019	Small Joint Arthroscopy System
7207935	Sterilization tray, holds up to eight Micro Instruments, plus probe
7207696	Trigger Finger Sterilization Tray (9"L x 10"W x 3"H)
4450	ECTRA° II System Hand Holder and Sterilization Tray with Cover

### For Hip Arthroscopy

7210643	Hip Access System Sterilization Tray
7207934	Hip Arthroscopy Sterilization Tray

### For Operative Hysteroscope Set

7205683	Hysteroscope Set sterilization tray. Includes silicone mat, cover, 12 posts, 12 tie-downs, post removal tool
---------	--

## Storage and Sterilization Trays

### Miscellaneous

REF	Description
011703	Small Sterilization Tray with mat (9.25"L x 3"W x 1.5"H)
7207369	Medium Sterilization Tray with mat (10.5"L x 6.5"W x 1.5"H)
7207357	Large Sterilization Tray with mat (13"L x 8"W x 1.25"H)
7205683	Autoclavable Storage and Sterilization Tray (20"L x 9"W x 2"H) Includes: Silicone mats, cover, 12 posts, 12 tie-downs, and post removal tool
8104237	Replacement Rubber Mat for Sterilization Tray REF 7207357

### For Endoscopes, Cameras

Autoclavable

Not for use with Steris® or Sterrad® sterilizers.

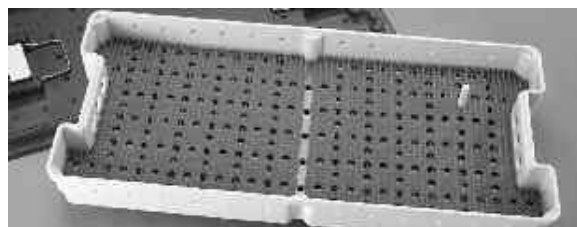

7205683



7208209



7204737

REF	Description
7205683	For autoclave sterilization of autoclavable camera heads, autoclavable rigid endoscopes, autoclavable couplers, and hand instruments. Dimensions are 20"L x 9"W x 2"H. Includes silicone mats, 12 posts, 12 tie-downs.
7205703	Replacement parts for REF 7205683 Sterilization Tray (shown above). Includes 12 posts, 12 tie-downs, and 1 post removal tool
4318	Arthroscope, Coupler and Camera Sterilization Tray (18"L x 8"W x 1.5"H)
7208209	Laparoscope/Hysteroscope Sterilization Tray (18"L x 2.5"W x 1.5"H), holds one rigid endoscope from 1.0 mm to 10 mm in diameter and up to 320 mm in length
7204737	Autoclavable Arthroscope Sterilization Tray (9.5"L x 3"W x 1.25"H), holds two Direct-View Autoclavable Arthroscopes
72200038	Bariatric Laparoscope Sterilization Tray (25"L x 6"W), holds two 10 mm Bariatric Laparoscopes

## Storage and Sterilization Trays/Personal Protection Items

### For Shavers and Blades

REF	Description
4323	Sterilization Tray for Smith & Nephew DYONICS®, EP-1®, or PS3500EP® Shaver Handpieces (motor drives) (18"L x 8.5"W x 3"H)
4324	Insert for REF 4323 Tray
7205787	Sterilization Tray for Smith & Nephew DYONICS Power Accessories (corded drill and saw) (20"L x 10"W x 3"H)

### CLOUD-9® Absorption Mat

The CLOUD-9 Absorption Mat is cost-effective because it reduces cleanup time. Captured fluids and debris are contained by folding up the corners of the mat.



REF	Description
7209461	CLOUD-9 Roll (40" x 200'), 2 rolls per package 40 x 100 each
7209462	CLOUD-9 Roll (25 disposable single sheets, each 40" x 5 1/2')

### Face Shields

These lightweight disposable face shield has a foam headband that contains air vents to reduce fog and condensation. The durable 7 mil, anti-fog shield provides eye protection without sacrificing vision.



7209463	Disposable Full Face Shield (complete face protection), box of 50
7209464	Disposable Half Face Shield (upper face protection), box of 50

### Fluid Barrier Boots

These durable, disposable, 6-gauge polyvinyl fluid barrier boots have been proven effective with the Bacteriophage Penetration Test. Boot seams are heat-sealed and soles are a continuous vinyl barrier to prevent tearing and leaks.



7209470	Disposable Knee-High Fluid Barrier Boots, 50 pairs per box Small: men up to size 7, women up to size 9
7209469	Disposable Knee-High Fluid Barrier Boots, 50 pairs per box Medium: men sizes 8-12, women sizes 9+
7209468	Disposable Knee-High Fluid Barrier Boots, 50 pairs per box Large: men sizes 12+

## Fracture Support Table

### Fracture Support Table

Provides leg support for tibial-fracture repair procedures

REF	Description
7210566	Fracture Support Table with gel pad
7210567	Fracture Support Table replacement pad
7210568	Table stabilization straps

## Made to Order

Made to Order products have longer production times. Please contact your sales representative or customer service for more information.

### Sterilization Tray for Hand-Held Instruments

REF	Description
7209334	25-unit Sterilization Tray, metal

### Jacobs Chuck Adaptor

7202914	Jacobs Chuck Adaptor
---------	----------------------

# Q

Smith & Nephew DYONICS®  
 VULCAN® Arthroscopy System ..... Q-1  
 SAPHYRE® Bipolar Ablation Probes ..... Q-2  
 Monopolar Ablation Probes ..... Q-3  
 DYONICS® GLIDER Articular  
 Cartilage Probe ..... Q-4  
 Temperature Control Probes ..... Q-5  
 LIGAMENT CHISEL® Probes ..... Q-6  
 Hip Probes ..... Q-7  
 Small Joint Probes ..... Q-8  
 Arthroscopic Electrodes, Probes,  
 and Switchpens ..... Q-9

## DYONICS® VULCAN® Arthroscopy System

Smith & Nephew ablation probes deliver powerful, consistent RF energy for vigorous tissue ablation and hemostasis. The jewel-cut electrodes deliver focused energy to target tissue with reduced current output requirements, while generating less heat than competitive ablation probes.

## Electrosurgery

### Product Highlights



#### DYONICS GLIDER

Articular Cartilage Probe debrides and smooths cartilage surfaces predictably and consistently, with a minimal amount of cell death.

DYONICS GLIDER  
 Page Q-4



#### TAC-S Probe

Advanced monopolar temperature control program is optimized for ligamentous soft tissue shrinkage in the shoulder.

TAC-S Probe  
 Page Q-5



#### LIGAMENT CHISEL

Probes provide unmatched precision in ligament resection and coagulation.

LIGAMENT CHISEL  
 Page Q-6

## Smith & Nephew DYONICS<sup>®</sup> VULCAN<sup>®</sup> Arthroscopy System

The Smith & Nephew DYONICS<sup>®</sup> VULCAN<sup>®</sup> Arthroscopy System is designed to help improve procedure efficiency and outcome with a complete line of RF products for knee, shoulder, hip, and small joint procedures.



### Flexible

Monopolar, bipolar, temperature control, and impedance monitoring capabilities aid in optimizing energy delivery to produce the desired tissue effect.

### Simple

All Smith & Nephew RF probes are available with integrated cables which increases staff efficiency by eliminating cable sterilization and storage requirements.

### Convenient

Autoprobe recognition takes the guesswork out of selecting power settings. Troubleshooting is facilitated with audible alarms and error message displays.

REF	Description
System includes: VULCAN <sup>®</sup> Generator, power cord, footswitch, and manual	
7210868	VULCAN Generator System, U.S.
7210869	VULCAN Generator System, Europe
7210870	VULCAN Generator System, U.K.
7210898	VULCAN Generator System, Australia
7210897	VULCAN Generator System, India
7210871	VULCAN Generator System, South Africa
7210872	VULCAN Generator System, Italy
7210812	VULCAN Generator
7209693	VULCAN Extension Cables (for use only with original version of EFLEX <sup>®</sup> Probes)
7209692	VULCAN Footswitch
7209687	Split Electrode Pads, 1 each
7209597	Probe Tip Bender

## SAPHYRE<sup>◇</sup> Bipolar Ablation Probes

Smith & Nephew SAPHYRE<sup>◇</sup> ablation probes deliver powerful, consistent RF energy for vigorous soft tissue ablation and hemostasis. The jewel-cut electrodes deliver focused energy to target tissue with reduced current output requirements, generating less heat than competitive ablation probes. In addition, the SAPHYRE Bipolar Ablation Probes COOLBACK Shaft reduces the risk of secondary tissue heating at the return electrode site.



REF	Description	Shaft Color
7209686	SAPHYRE Bipolar Ablation Probe, 90°	Pewter
7209685	SAPHYRE Bipolar Ablation Probe, 60°	Pewter
7209684	SAPHYRE Bipolar Ablation Probe, 90° high profile	Pewter

### Smith & Nephew SAPHYRE II Bipolar Ablation Probes

The Smith & Nephew SAPHYRE II Bipolar Ablation probes have integrated suction for enhanced visualization in the sterile field.

7210111	SAPHYRE II Bipolar Ablation Probe with suction, 90°	Pewter
7210113	SAPHYRE II Bipolar Ablation Probe with suction, 60°	Pewter
7210112	SAPHYRE II Bipolar Ablation Probe with suction, 90° high profile	Pewter
7210491	SAPHYRE II Bipolar Ablation Probe with suction, 40°	Pewter



## Monopolar Ablation Probes



### Smith & Nephew ABLATOR® Probes

The Smith & Nephew ABLATOR probes provide a wide scope of probe styles for arthroscopic applications in the shoulder, knee, and small joint. Features such as the POWER POCKET® electrode high-flow extractor lumen on suction probes help optimize tissue ablation, coagulation, and visualization of the surgical site.

REF	Description	Shaft Color
7209659	ABLATOR Monopolar Ablation Probe, 90°	Black
7209654	ABLATOR-S Monopolar Ablation Probe, 90° with suction	Black
7209657	ABLATOR Monopolar Ablation Probe, 60°	Black
7209653	ABLATOR-S Monopolar Ablation Probe, 60° with suction	Black
7209655	ABLATOR Monopolar Ablation Probe, 90° high profile	Black
7209651	ABLATOR-S Monopolar Ablation Probe, 90° high profile with suction	Black
7209650	ABLATOR Monopolar Ablation Probe, 60°, 2.0 mm	Black
7209652	ABLATOR-S Monopolar Ablation Probe, 60°, 2.0 mm with suction	Black
7209658	ABLATOR Monopolar Ablation Probe, 30°	Black
7209656	Micro ABLATOR Probe, 60°	Black
7209641	Micro ABLATOR-S Probe, 60° with suction	Black
7209666	EFLEX® ABLATOR probe	Black
72200683	EFLEX ABLATOR Probe with integrated cable	Black

### Smith & Nephew SCULPTOR® Probes

Smith & Nephew SCULPTOR ABLATOR probes combine the power of monopolar ablation with consistent, vigorous, predictable soft tissue removal and hemostasis.

7210698	SCULPTOR ABLATOR Probe, 90°	Black
7210697	SCULPTOR ABLATOR-S Probe, 90° with suction	Black
7210700	SCULPTOR ABLATOR Probe, 90° high profile	Black
7210695	SCULPTOR ABLATOR-S Probe, 90° high profile with suction	Black
7210699	SCULPTOR ABLATOR Probe, 60°	Black
7210696	SCULPTOR ABLATOR-S Probe, 60° with suction	Black

## DYONICS<sup>®</sup> GLIDER<sup>®</sup> Articular Cartilage Probe

Designed exclusively for treatment of chondromalacia, indicated specifically for chondroplasty.

The DYONICS<sup>®</sup> GLIDER probe debrides and smooths diseased cartilage along the contoured surfaces of the joint while limiting the depth of chondrocyte death to 150 microns or less.

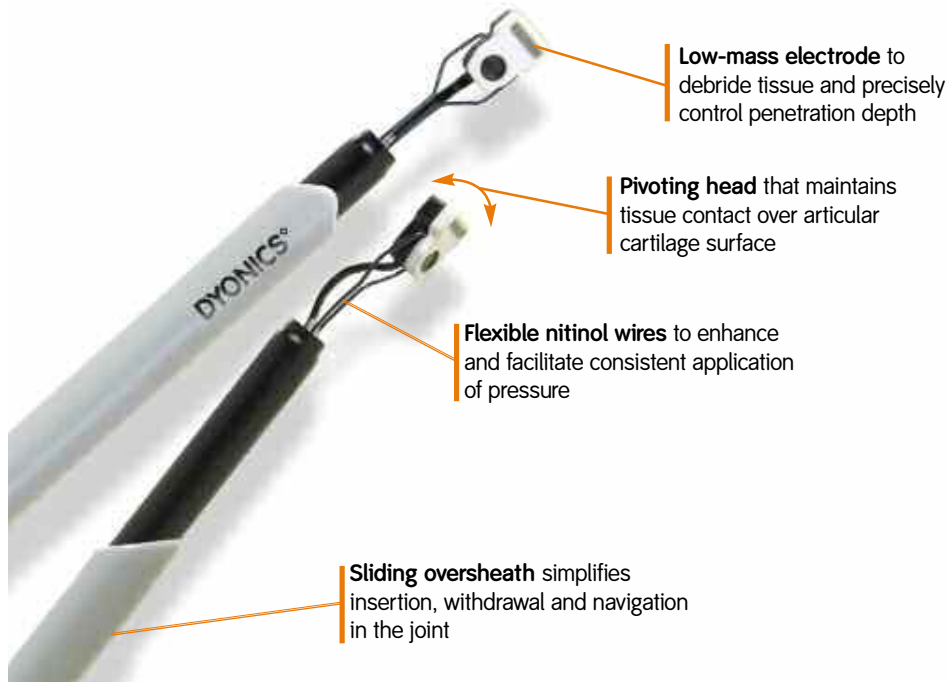

### DYONICS GLIDER Articular Cartilage Probe

The Smith & Nephew DYONICS GLIDER Articular Cartilage Probe is an early-intervention tool for treatment of articular cartilage disease. Through controlled application of RF energy on Grade II and III chondromalacia, the GLIDER probe is designed to maximize preservation of healthy cartilage tissue while restoring a smooth gliding surface.

REF	Description	Shaft Color
7210438	DYONICS GLIDER Articular Cartilage Probe	Black
Optional:		
7210977	Reuseable slotted cannula	

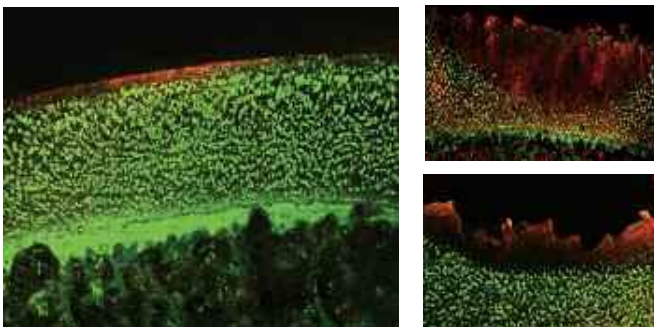

### Creates a smooth cartilage surface

*In vitro* studies have demonstrated the DYONICS GLIDER probe creates a smooth cartilage surface with a superficial layer of cell death. The images compare the depth of cell death achieved with the DYONICS GLIDER probe versus all-purpose arthroscopic radiofrequency (RF) devices.

Cell viability images. Red is dead, green is live.  
Measurement bar = 100  $\mu$ m.

## Temperature Control Probes



### Smith & Nephew TAC<sup>®</sup> Probes

The Smith & Nephew TAC<sup>®</sup> probes are indicated for ligament shrinkage in the shoulder as well as coagulation of soft tissue in the knee, hip, and small joints. Each TAC probe tip contains a sensor that relays tissue temperature back to the generator, enabling automatic selection and control of tissue temperature during treatment. All TAC probes incorporate a malleable shaft for added flexibility.

REF	Description	Shaft Color
7209630	TAC-S Probe, angled	Blue
7209628	TAC-C II Probe	Blue
7209633	TAC-S Probe	Blue
7209632	Mini TAC-S Probe	Blue
7209629	Micro TAC-S Probe, angled	Blue
7209631	Micro TAC-S Probe	Blue
7209637	EFLEX <sup>®</sup> TAC-S Probe	Blue
72200681	EFLEX TAC-S Probe with integrated cable	Blue

## LIGAMENT CHISEL<sup>®</sup> Probes



The Smith & Nephew LIGAMENT CHISEL probes provide focused and precise resection, ablation, and hemostasis of dense soft tissue in the shoulder, knee, hip, and small joints. All probes incorporate a malleable shaft for added flexibility and access to difficult-to-reach areas.

REF	Description	Shaft Color
7209647	LIGAMENT CHISEL Probe, curved	Green
7209648	LIGAMENT CHISEL Probe, angled	Green
7209646	LIGAMENT CHISEL Probe, hook	Green
7209649	LIGAMENT CHISEL Probe, straight	Green
7209643	Micro LIGAMENT CHISEL Probe, hook	Green
7209645	Micro LIGAMENT CHISEL Probe, angled	Green
7209644	Micro LIGAMENT CHISEL Probe, curved	Green
7209663	EFLEX <sup>®</sup> LIGAMENT CHISEL Probe	Green
72200682	EFLEX LIGAMENT CHISEL Probe with integrated cable	Green

## Hip Probes



### Smith & Nephew DYONICS® EFLEX® Radiofrequency Probes

Smith & Nephew DYONICS EFLEX RF probes can deflect up to 100°, enabling access into areas of the hip joint that are difficult to reach with conventional rigid probes. Tip deflection is actuated by an easy-to-pull trigger system, with an ergonomically designed handle and palm grip. EFLEX probes are also available with an integrated power cable, eliminating the need to purchase and re-sterilize separate cables.

REF	Description
7209666	DYONICS EFLEX ABLATOR Probe
7209663	DYONICS EFLEX LIGAMENT CHISEL Probe
7209637	DYONICS EFLEX TAC®-S Probe
7209693	VULCAN® Extension cable
72200683	DYONICS EFLEX ABLATOR® Probe with integrated cable
72200682	DYONICS EFLEX LIGAMENT CHISEL® Probe with integrated cable
72200681	DYONICS EFLEX TAC-S Probe with integrated cable

### DYONICS GLIDER® Articular Cartilage Probe

The Smith & Nephew DYONICS GLIDER Articular Cartilage Probe is an early-intervention tool for treatment of articular cartilage disease. Through controlled application of RF energy on Grade II and III chondromalacia, the GLIDER probe is designed to maximize preservation of healthy cartilage tissue while restoring a smooth gliding surface.

REF	Description	Shaft Color
7210438	DYONICS GLIDER Articular Cartilage Probe	Black
Optional:		
7210977	Reuseable slotted cannula	

## Small Joint RF Probes

### Smith & Nephew Small Joint RF Probes

Smith & Nephew offers a versatile and comprehensive selection of RF probes for use in a variety of small joint arthroscopic procedures.







REF	Description	Color
7209656	Micro ABLATOR® Probe, 60°	Black
7209641	Micro ABLATOR-S Probe, 60° with suction	Black
7209643	Micro LIGAMENT CHISEL® Probe, hook	Green
7209645	Micro LIGAMENT CHISEL Probe, angled	Green
7209644	Micro LIGAMENT CHISEL Probe, curved	Green
7209632	Mini TAC® S	Blue
7209629	Mini TAC S, angled	Blue
7209631	Mini TAC S, probe	Blue

## Arthroscopic Electrodes, Probes, and Switchpens

### Arthroscopic Electrodes

Insulated for use in all fluids.

	REF	Description
	7205441	Electrode, 90° L-hook tip, 170 mm working length, for use with REF 7205440 Switchpen or standard Valleylab® Switchpen, box of 10
	7205442	Electrode, 45° tip, 170 mm working length, for use with REF 7205440 Switchpen or standard Valleylab® Switchpen, box of 10
	7205443	Electrode, 90° flat tip, 170 mm working length, for use with REF 7205440 Switchpen or standard Valleylab® Switchpen, box of 10
	7205774	Electrode, 90° L-hook tip, short, 126 mm working length, for use with REF 7205440 Switchpen or standard Valleylab® Switchpen, box of 10

### Complete Probe and Pen Kit

Insulated for use in all fluids.

	7205565	Switchpen with L-hook electrode, for use in fluid media, box of 5
---	---------	---

### Switchpen

Insulated for use in all fluids.

	7205440	Switchpen, monopolar, leakproof, anti-rotating interface allows electrode positioning in eight fixed orientations, for use with REF 7205774, 7205443, 7205442, and 7205441, box of 5
---	---------	--

# R

## Powered Instruments

Smith & Nephew DYONICS® POWER Instrumentation (battery-operated) .....	R-1
Accessories .....	R-2
Smith & Nephew DYONICS® POWER Instrumentation (corded) .....	R-4
Accessories .....	R-6



## Smith & Nephew DYONICS<sup>®</sup> POWER Instrumentation (battery-operated)

### Battery Operated Power Equipment

REF	Description
 2851	450 Drill, with battery, 1/4" Jacobs Chuck
 2855	Sagittal Saw, with battery
 2856	800 Wire Driver, with battery

## Accessories

### Charger, Power Pack, and Chuck Key







	REF	Description
	2863	Pac II Battery, 6.0 VDC, box of 2
	3082	MPC IV Charger, 110 VAC*
	3438	Jacobs Chuck Key

\* Batteries not included with charger

## Accessories

### Sterile, Disposable Saw Blades<sup>†</sup>

For use with Sagittal Saw, REF 2855

REF	Description
 3701	Saw Blade – Standard, thickness: 0.65 mm, length: 63 mm, box of 6
 3702	Saw Blade – Standard, thickness: 0.89 mm, length: 63 mm, box of 6
 3703	Saw Blade – Short, thickness: 0.65 mm, length: 29 mm, box of 6
 3704	Saw Blade – Short, Narrow, thickness: 0.65 mm, length: 29 mm, box of 6
 3705	Saw Blade – Narrow, thickness: 0.65 mm, length: 63 mm, box of 6
 3706	Saw Blade – Long, special thickness: 0.89 mm, length: 68 mm, box of 6

<sup>†</sup> All saw blades have graduated markings every 5 mm

## Smith & Nephew DYONICS<sup>®</sup> POWER Instrumentation (corded)

### Corded Power Equipment

For use with Smith & Nephew DYONICS<sup>®</sup> POWER Control Unit (see pg. D-2). The drill's design and choice of modular accessories provide smooth switching of components during arthroscopic surgery. For the sagittal saw, you may choose from multiple blades with varying sizes.

	REF	Description
	7205785	Pistol Grip Drill (requires REF 7205788)
	7205786	Inline Sagittal Saw (requires REF 7205788)
	7205791	Sagittal Saw Module (used with REF 7205785)
	7205787	Sterilization Tray (holds all components including drill and saw)

## Smith & Nephew DYONICS<sup>®</sup> POWER Instrumentation (corded)







### Instrumentation

	REF	Description
	7209391	Smith & Nephew DYONICS POWER high-speed drill (model 6100)
	7209394	Smith & Nephew DYONICS POWER oscillating saw, MicroAire <sup>®</sup> interface (model 6710)
	7209392	Smith & Nephew DYONICS POWER reciprocating saw, MicroAire interface (model 6420)
	7209395	Smith & Nephew DYONICS POWER heavy-duty oscillating saw, MicroAire interface (model 6740)
	8103998	Smith & Nephew DYONICS POWER locking wrench
	7209393	Smith & Nephew DYONICS POWER Synthes chuck

## Accessories

### Wire Driver, Pin Driver, Chucks, and Cable



For use with Smith & Nephew DYONICS® POWER Control Unit.

	REF	Description
	7205789	Automatic Wire Driver (accepts wires up to 1.6 mm)
	7205790	Automatic Pin Collet (accepts pins up to 3.2 mm)
	7205792 8104907	Jacobs Chuck, 5/32" Chuck Key
	7205793 3438	Jacobs Chuck, Keyless, 1/8" Chuck Key
	7205794	Jacobs Chuck, 1/4"
	7205795	Jacobs Chuck, Keyless, 1/4"
	7205788	Power Cable (from drill and/or sagittal saw to control unit)

## Accessories

### Disposable Saw Blades for Smith & Nephew DYONICS® POWER Instrumentation

For use with Sagittal Saws REF 7205786 or 7205791. Disposable, packaged 6 per box, sterile.

	REF	Description
	7209396	DYONICS sagittal saw blade, 5.8 mm x 12 mm x 0.4 mm, with straight fine teeth, no etchings, depth stop
	7209397	DYONICS sagittal saw blade, 5.8 mm x 18 mm x 0.4 mm, with straight fine teeth with markings, depth stop

### Sagittal Saw Blades (WxLxT)

For use with Sagittal Saws REF 7205786 or 7205791. Disposable, packaged 6 per box, sterile.

	7205809	Saw Blade, 9.4 mm x 15 mm x 0.4 mm, with 15 mm depth stop, Titanium Nitride finish, No etching
--	---------	--

### Sagittal Saw Blades with Depth Stops







For use with Sagittal Saws REF 7205786 or 7205791. Disposable, packaged 6 per box, sterile.

	7205807	Saw Blade, 9.4 mm x 10 mm x 0.4 mm, with 10 mm depth stop, Titanium Nitride finish, No etching
	7205808	Saw Blade, 9.4 mm x 12 mm x 0.4 mm, with 12 mm depth stop, Titanium Nitride finish, No etching
	7205898	Saw Blade, 9.4 mm x 10 mm x 0.4 mm, with 10 mm depth stop, without Titanium Nitride finish, No etching
	7205899	Saw Blade, 9.4 mm x 12 mm x 0.4 mm, with 12 mm depth stop, without Titanium Nitride finish, No etching
	7205900	Saw Blade, 9.4 mm x 15 mm x 0.4 mm, with 15 mm depth stop, without Titanium Nitride finish, No etching

## Accessories

### Calibrated Sagittal Saw Blades (WxLxT)

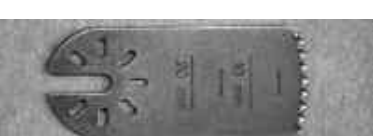
For use with Sagittal Saws REF 7205786 or 7205791. Disposable, packaged 6 per box, sterile.

	REF	Description
	7205802	Saw Blade, 19.1 mm x 25.4 mm x 0.4 mm, with markings
	7205803	Saw Blade, 5.8 mm x 25.4 mm x 0.4 mm, with markings
	7205804	Saw Blade, fine teeth, 9.4 mm x 25.5 mm x 0.4 mm, with markings
	7205805	Saw Blade, 9.4 mm x 25.5 mm x 0.4 mm, with markings
	7205806	Saw Blade, 4.5 mm x 25.5 mm x 0.4 mm, with markings
	7205895	Saw Blade, 19.1 mm x 25.4 mm x 0.4 mm, with markings and Titanium Nitride finish
	7205896	Saw Blade, 5.8 mm x 25.4 mm x 0.4 mm, with markings and Titanium Nitride finish
	7205897	Saw Blade, fine teeth, 9.4 mm x 25.5 mm x 0.4 mm, with markings and Titanium Nitride finish



# S

## Endosurgery

Smith & Nephew Operative Hysteroscopy System .....	S-1
Individual Components .....	S-2
INTERCEPTRE <sup>®</sup> Modular Instruments .....	S-3
Laparoscopic Instruments .....	S-5
Smith & Nephew 400 Insufflator .....	S-7
Made to Order .....	S-8

## Smith & Nephew Operative Hysteroscopy System



The Smith & Nephew Operative Hysteroscopy System offers patients a safe technique for removal of endometrial polyps and submucous fibroids. The system provides a one-step morcellation and aspiration tissue removal process without using electro-surgery.

### Smith & Nephew Operative Hysteroscopy System

REF	Description
7210389	Smith & Nephew Operative Hysteroscopy System
System includes:	
7209808	Hysteroscopic Morcellation Control Unit
7209820	Hysteroscopic System Footswitch
7209807	Hysteroscopic Morcellator Handpiece
7210164	Hysteroscopic Fluid Management System Control Unit
7210165	Hysteroscopic Fluid Monitor Stand
7210166	Hysteroscopic Roller Base
72200094	Hysteroscopic Vacuum Regulator
7210473	Manuals and power cords

### Smith & Nephew Operative Hysteroscope Set

7211068	Smith & Nephew Operative Hysteroscope Set
Set includes:	
7209208	Operative Hysteroscope
7209383	Operative Hysteroscope Sheath
7209384	Operative Hysteroscope Obturator
7205561	Hysteroscope seal cap, box of 5

## Smith & Nephew Operative Hysteroscopy System

### Individual Components

#### Smith & Nephew Operative Hysteroscopy Components

REF	Description
7209807	Hysteroscopic Morcellator Handpiece
7209208	Operative Hysteroscope
7209383	Operative Hysteroscope Sheath
7209384	Operative Hysteroscope Obturator

#### Smith & Nephew Operative Hysteroscopy Autoclavable Sterilization Tray

7205683	Hysteroscope Set sterilization tray. Includes silicone mat, cover, 12 posts, 12 tie-downs, post removal tool
---------	--

#### Smith & Nephew Operative Hysteroscopy Disposable Morcellators

7210908	Hysteroscopic Reciprocating Morcellator, 1 each
7209509	Hysteroscopic Rotary Morcellator, 1 each

#### Smith & Nephew Operative Hysteroscopy Disposable Tube Sets

7209827	Hysteroscopic Procedure Kit. Includes Inflow Tube Set, Outflow Tube Set, and Canister Kit (4 jumper tubes and Bemis tissue trap)
7209824	Canister Kit, includes Bemis tissue trap and 4 jumper tubes (international only)
7209822	Hysteroscopic Inflow Tube Set, 10 per box
7209823	Hysteroscopic Outflow Tube Set, 5 per box

#### Smith & Nephew Operative Hysteroscopy Disposable Instrument Detection Insert

7211067	Hysteroscope Insert, 1 each
---------	-----------------------------

#### Smith & Nephew Operative Hysteroscopy Disposable Canisters

72200024	Bemis Canister, 36 per box
----------	----------------------------

## INTERCEPTRE<sup>◇</sup> Modular Instruments

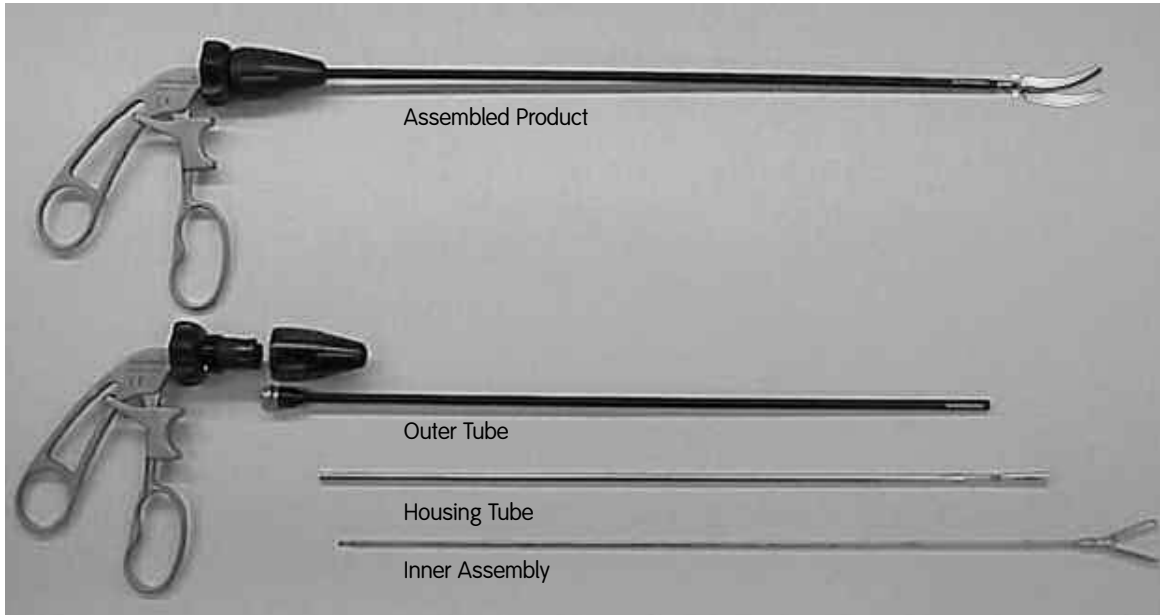

### INTERCEPTRE Laparoscopic Instruments

INTERCEPTRE laparoscopic instruments offer the combination of the strength and precision of one-piece instruments with a convenient modular design that facilitates cleaning and economy of purchase — instruments can be ordered complete or in parts for total flexibility.

All instruments are 330 mm working length

Complete instrument consists of one each: Handle, Housing Tube, Inner Assembly, Outer Tube, and Nose Cap

Modular design

Ergonomic handle

Permanently sharp, economical scissors ensured by replaceable scissors tips

Pinless hinge gives exceptional holding power and strength

Instruments can be ordered complete or in parts for total flexibility of purchase



Handle with Electro-surgical Post



Handle (locking)



5.0 mm Nose Cap



10 mm Nose Cap

## INTERCEPTRE<sup>◇</sup> Modular Instruments

### Scissors – INTERCEPTRE



Low distal insulation for increased safety in an electrosurgical environment; handle features electrosurgical post; always sharp and economical; easy-to-replace blades with a “No Thread” mechanism that ensures they cannot detach during surgery.

	REF	Description
	7208298	Curved Metzenbaum – Assembled Product
	7208302	Handle with Electrosurgical Post
	7208305	Outer Tube
	7209540	Scissors Blade
	7209712	Housing Tube
	7209777	5.0 mm Nose Cap
	7208299	Straight Metzenbaum – Assembled Product
	7208302	Handle with Electrosurgical Post
	7208305	Outer Tube
	7209541	Scissors Blade
	7209712	Housing Tube
	7209777	5.0 mm Nose Cap
	7208300	Hook – Assembled Product
	7208302	Handle with Electrosurgical Post
	7208305	Outer Tube
	7209542	Scissors Blade
	7209712	Housing Tube
	7209777	5.0 mm Nose Cap

## Laparoscopic Instruments









All dissecting instruments can be rotated 360°  
All are fully insulated and have monopolar electro-surgical capabilities

Laparoscopic instruments that utilize the tried and tested ACUFEX® pinless hinge design offer superior reliability and strength. The high quality of this design has been proven with over 14 years experience in manufacturing arthroscopic instruments.

### Dissectors

5.0 mm diameter, 330 mm working length.

	REF	Description
	7205617	Maryland
	7205619	Fine Tip
	7205616	Curved Crile
	7205615	Straight Crile
	7205614	Meeker
	7205620	Olive Tip
	7205618	Dolphin Nose

## Laparoscopic Instruments



All graspers have a ratcheted locking mechanism

Dual action graspers can be rotated through 360°

Insulated shaft for additional safety in an electrosurgical environment

### Graspers

5.0 mm diameter, 330 mm working length.

	REF	Description
	7205609	Single Action Atraumatic
	7205611	Single Action Retraction Forceps
	7205610	Dual Action Atraumatic (rotatable)
	7205612	Dual Action Retraction Forceps (rotatable)

## Smith & Nephew 400 Insufflator



### Smith & Nephew 400 Insufflator

The Smith & Nephew 400 Insufflator is the only insufflator with TAP, which delivers warmed CO<sub>2</sub> gas during laparoscopic surgery without an external control unit. Warmed gas is delivered through a unique in-line mechanism in close proximity to the patient for maximum effectiveness. In addition, the Smith & Nephew 400 Insufflator incorporates an additional safety feature that prevents inadvertent changes in gas flow rate and abdominal pressure during the procedure.

If your operating room is equipped with a Digital O.R. System, the Smith & Nephew 400 Insufflator can be externally controlled using the Smith & Nephew CONDOR® interface kit.

In-line insufflator gas warming capability is provided through one or two parts.

A stop safety feature prevents intra-abdominal pressure from exceeding 15 mmHg.

A TAP feature acts as an independent abdominal pressure monitoring line.

Simple front panel design is arranged in three distinct sections: one for gas supply, one for gas flow rate control, and one for abdominal pressure regulation.

REF	Description
7209932	Smith & Nephew 400 Insufflator System, U.S.
7209934	Smith & Nephew 400 Insufflator System, U.K.
7209936	Smith & Nephew 400 Insufflator System, German
7209938	Smith & Nephew 400 Insufflator System, Spanish
7209940	Smith & Nephew 400 Insufflator System, French
7209942	Smith & Nephew 400 Insufflator System, Italian

### Smith & Nephew 400 Accessories

REF	Description
7209944	Smith & Nephew In-line Gas Warmer, 8 pin
7210017	Smith & Nephew 400 Insufflator System HERMES Interface Kit
7205861	Smith & Nephew 400 Insufflator System Tubing, disposable, 10 per box
7205836	TAP Tubing Set, disposable, 10 per box
4270	High Pressure Hose/Clamp for connecting extra CO <sub>2</sub> source
7205972	DISS Connector with 6 ft Hose
7205868	Warmer for 40L insufflator (4 pins)

### Smith & Nephew 400 Insufflator Disposables

REF	Description
7205861	Insufflation Tubing, disposable, 10 kits per box
7205836	TAP Tubing Set, disposable, 10 kits per box



## Made to Order

Made to Order products have longer production times. Please contact your sales representative or customer service for more information.

### Laparoscopic Cannular Sets

REF	Description
8001	10 mm Laparoscopic Cannula, with trumpet valve and stopcock
8002	10 mm Laparoscopic Trocar, Conical
8003	10 mm Laparoscopic Trocar
8004	5.0 mm Laparoscopic Cannula, with trumpet valve and stopcock
8006	5.0 mm Laparoscopic Trocar

### Accessories

6900080	Insufflator Adaptor
---------	---------------------



**Endoscopy**  
Smith & Nephew, Inc.  
150 Minuteman Road  
Andover, MA 01810  
USA

Telephone: +1 978 749 1000  
Orders/Inquiries +1 800 343 5717

[www.smith-nephew.com](http://www.smith-nephew.com)  
[endo.smith-nephew.com](http://endo.smith-nephew.com)